

SPPJ2 2.5mm-travel Horizontal Type

Detector

Slide

Push

Rotary

Power

Dual-in-line
Package Type

Horizontal
Type

Vertical
Type

Dimensions

Unit:mm

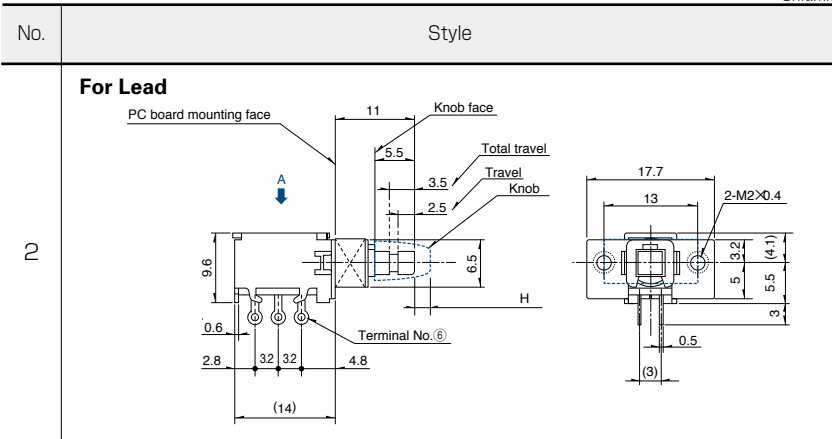

Actuator Configuration at Front Edge

Unit:mm

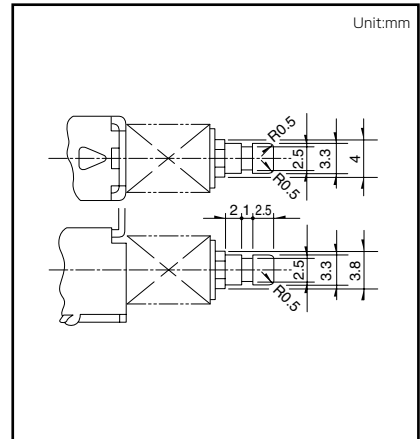

Terminal Configuration

Unit:mm

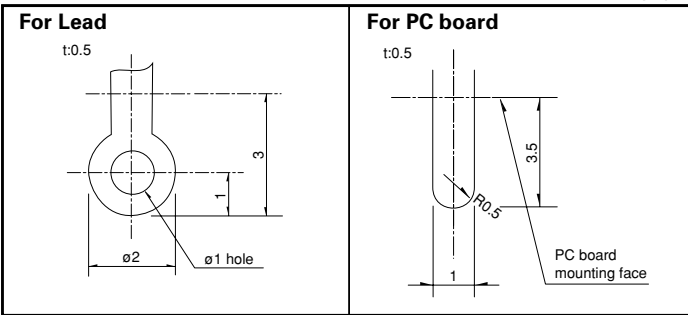

Circuit Diagram (Viewed from Direction A)

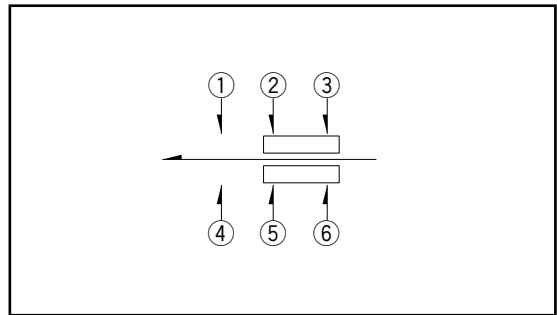

Attached Parts Please specify required knob.

Unit:mm

Knob outline drawing	Model	Knob attachment height (H)
<p>Square knob</p>	<p>Color:Black</p> <p>UE201011</p>	5
<p>Round knob</p>	<p>Color:Black</p> <p>UE200011</p>	9





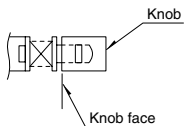





Notes

1. Other knob varieties are also available. Please inquire.
2. We recommend the use of adhesive to secure the knob when mounting onto switches.



Push Switches

List of Varieties

Series		Horizontal				
		SPPJ3	SPPJ2	SPUJ	SPUN	SPUN medium current
Photo						
Dimensions (mm)	W	5 or 6.6	7.2	7.5	10	
	D	12		15.2 22.7	24 36	
	H	8.3	9.6	8.8	13	
Travel (mm)		2.5		2	2.5	
Total travel (mm)		3.5		3	3.5	
Number of poles		1 2	2	2 4		
Operating temperature range		-40°C to +85°C		-10°C to +60°C		
Automotive use		●	●	—	—	—
Life cycle						
Rating (max.) (Resistive load)		0.2A 30V DC		0.1A 30V DC		1A 25V DC
Rating (min.) (Resistive load)		50μA 3V DC				—
Durability	Operating life without load	10,000 cycles 40mΩ max.			30,000 cycles 40mΩ max.	10,000 cycles 40mΩ max.
	Operating life with load (at max. rated load)	10,000 cycles 40mΩ max.			5,000 cycles 40mΩ max.	
Electrical performance	Initial contact resistance	20mΩ max.				
	Insulation resistance	100MΩ min. 500V DC				
	Voltage proof	500V AC for 1minute				
Mechanical performance	Terminal strength	5N for 1minute				
	Actuator strength	Operating direction	50N	30N	50N	
		Pulling direction	—	—	50N	
Environmental performance	Cold	-40°C 96h	-20°C 96h			
	Dry heat	85°C 96h				
	Damp heat	40°C, 90 to 95%RH 96h				
Page		111	113	115	117	

Push Switches Soldering Conditions	130
Push Switches Cautions	131

Note

● Indicates applicability to all products in the series.

Example of Reflow Soldering Condition

1. Heating method: Double heating method with infrared heater.
2. Temperature measurement: Thermocouple ϕ 0.1 to 0.2 CA (K) or CC (T) at soldering portion (copper foil surface). A heat resisting tape should be used for fixed measurement.
3. Temperature profile



Series (Reflow type)	A (°C) 3s max.	B (°C)	C (s)	D (°C)	E (°C)	F (s)
SPEJ	260	230	40	180	150	120
SPEF						
SPEH						

Notes

1. The condition mentioned above is the temperature on the mounting surface of a PC board. There are cases where the PC board's temperature greatly differs from that of the switch, depending on the PC board's material, size, thickness, etc. The above-stated conditions shall also apply to switch surface temperatures.
2. Soldering conditions differ depending on reflow soldering machines. Prior verification of soldering condition is highly recommended.

Reference for Hand Soldering

Series	Soldering temperature	Soldering time
SPPJ3, SPPJ2, SPUN, SPPH4, SPPH1	350±10°C	3+1/0s
SPED2, SPED4	350±10°C	3±0.5s
SPEJ	350±10°C	4s max.
SPEF	350±5°C	3s max.
SPEH	350°C max.	3s max.
SPUJ	300±10°C	3+1/0s

Reference for Dip Soldering

(For PC board terminal types)

Series	Items		Dip soldering	
	Preheating temperature	Preheating time	Soldering temperature	Duration of immersion
SPPJ3	100°C max.	60s max.	260±5°C	5±1s
SPUN	100°C max.	60s max.	260±5°C	10±1s
SPUJ, SPPH4	—		260±5°C	5±1s
SPPJ2, SPPH1, SPED2, SPED4, SPEF	—		260±5°C	10±1s