

Product Summary

- $V_R = 40V$
- $I_F = 1A$
- $I_R = 50\mu A$

Description and Applications

- DC – DC Converters
- Mobile Telecomms
- PCMCIA & SCSI

Features and Benefits

- High current capability ($I_F = 1A$)
- Low V_F
- **Qualified to AEC-Q101 Standards for High Reliability**

Mechanical Data

- Case: SOT23
- Case Material: Molded Plastic, "Green" Molding Compound. UL Flammability Classification Rating 94V-0
- Moisture Sensitivity: Level 1 per J-STD-020
- Terminals: Matte Tin Finish annealed over Alloy 42 leadframe (Lead Free Plating). Solderable per MIL-STD-202, Method 208
- Weight: 0.0089 grams (approximate)

SOT23



Top View

Ordering Information (Note 1)

Device	Packaging	Shipping
ZHCS1000TA	SOT23	3000/Tape & Reel

 Notes: 1. For Packaging Details, go to our website at <http://www.diodes.com>.

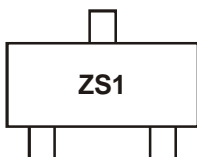
Marking Information

ZS1 = Product Type Marking Code

Maximum Ratings @ $T_A = 25^\circ\text{C}$ unless otherwise specified

Characteristic	Symbol	Value	Units	
Continuous Reverse Voltage	V_R	40	V	
Continuous Forward Current	I_F	1	A	
Forward Voltage @ $I_F = 1\text{A}$ (typ)	V_F	425	mV	
Average Peak Forward Current; D.C. = 50%	I_{FAV}	1750	mA	
Non Repetitive Forward Current	I_{FSM}	$t \leq 100\mu\text{s}$	12	A
		$t \leq 10\text{ms}$	5.2	A

Thermal Characteristics

Characteristic	Symbol	Value	Unit
Power Dissipation, $T_A = 25^\circ\text{C}$	P_D	500	mW
Junction Temperature	T_J	125	$^\circ\text{C}$
Storage Temperature Range	T_{STG}	-55 to +150	$^\circ\text{C}$

Electrical Characteristics @ $T_A = 25^\circ\text{C}$ unless otherwise specified

Characteristic	Symbol	Min	Typ	Max	Unit	Test Condition
Reverse Breakdown Voltage	$V_{(BR)R}$	40	60	-	V	$I_R = 300\mu\text{A}$
Forward Voltage (Note 2)	V_F	-	240	270	mV	$I_F = 50\text{mA}$
		-	265	290		$I_F = 100\text{mA}$
		-	305	340		$I_F = 250\text{mA}$
		-	355	400		$I_F = 500\text{mA}$
		-	390	450		$I_F = 750\text{mA}$
		-	425	500		$I_F = 1\text{A}$
		-	495	600		$I_F = 1.5\text{A}$
		-	420	-		$I_F = 1\text{A}, T_A = 100^\circ\text{C}$
Reverse Current	I_R	-	50	100	μA	$V_R = 30\text{V}$
Diode Capacitance	C_D	-	25	-	pF	$f = 1\text{MHz}, V_R = 30\text{V}$
Reverse Recovery Time	t_{rr}	-	12	-	ns	Switched from $I_F = 500\text{mA}$ to $I_R = 500\text{mA}$ Measured @ $I_R = 50\text{mA}$

Notes: 2. Measured under pulsed conditions. Pulse width = $300\mu\text{s}$. Duty cycle = 2%.

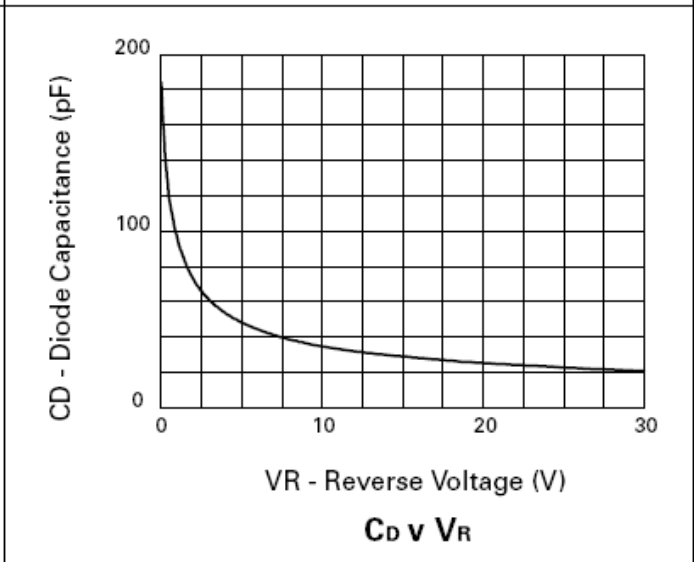
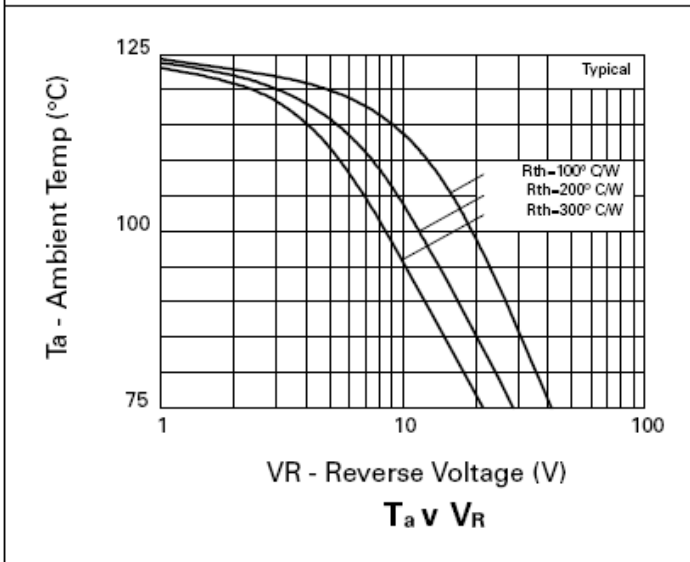
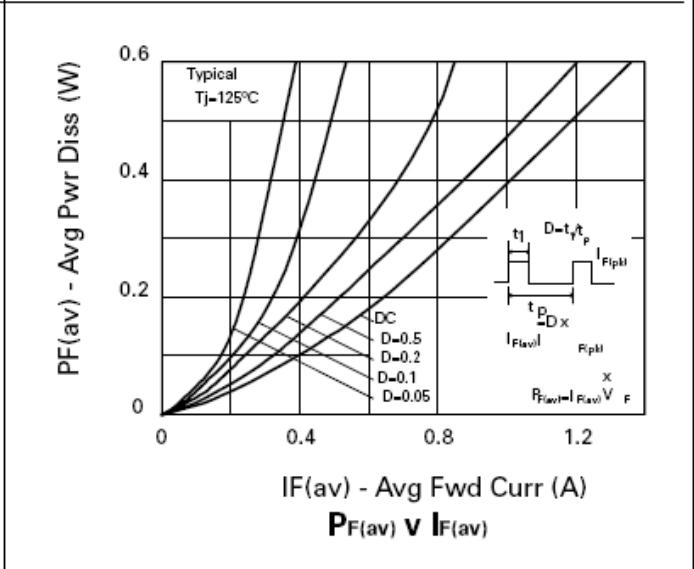
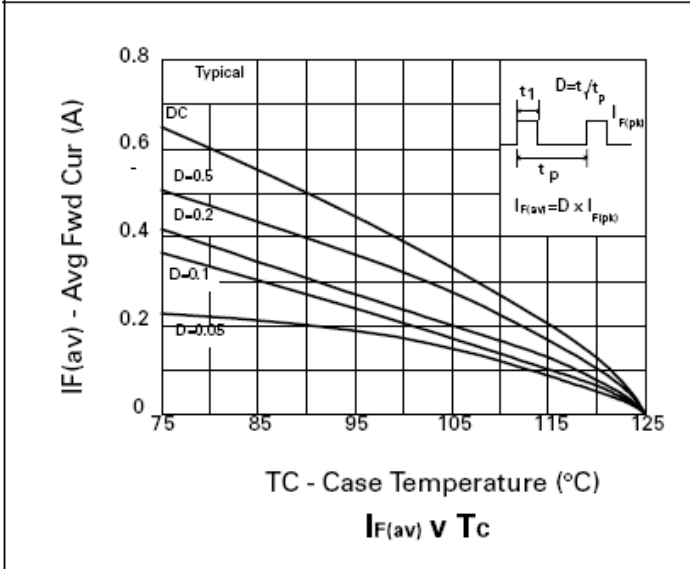
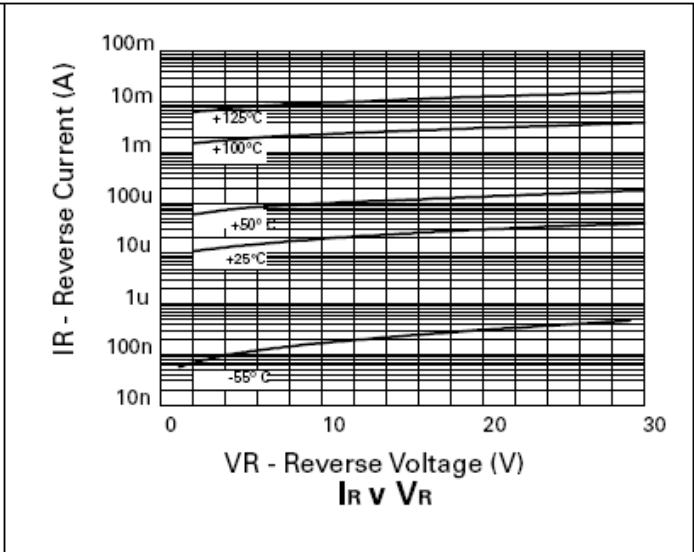
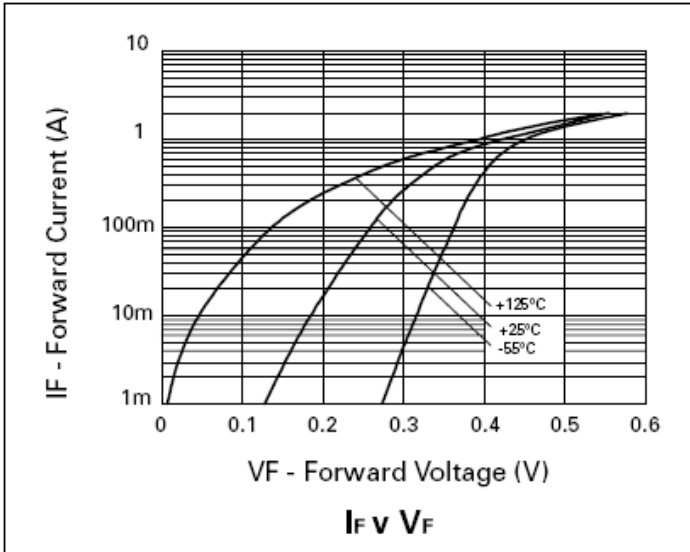

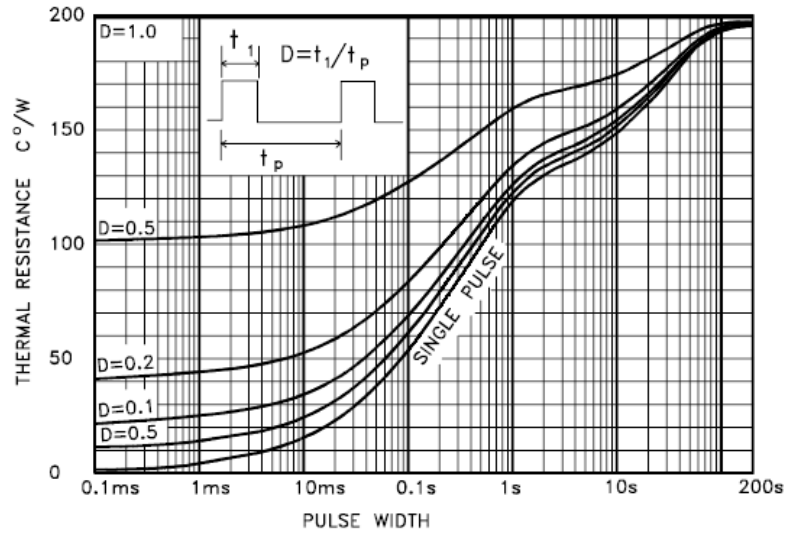

MAXIMUM TRANSIENT THERMAL RESISTANCE*

* Devices were mounted on a 15mmx15mm ceramic substrate.

Package Outline Dimensions

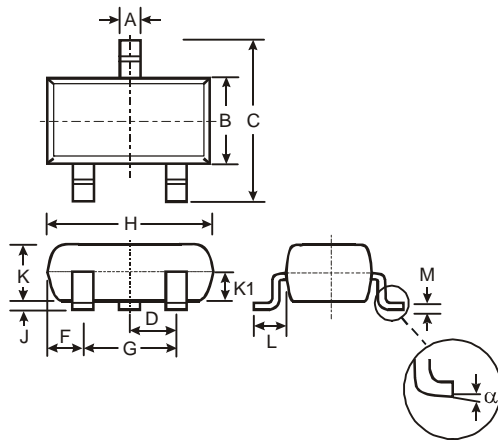

SOT-23			
Dim	Min	Max	Typ
A	0.37	0.51	0.40
B	1.20	1.40	1.30
C	2.30	2.50	2.40
D	0.89	1.03	0.915
F	0.45	0.60	0.535
G	1.78	2.05	1.83
H	2.80	3.00	2.90
J	0.013	0.10	0.05
K	0.903	1.10	1.00
K1	-	-	0.400
L	0.45	0.61	0.55
M	0.085	0.18	0.11
α	0°	8°	-

All Dimensions in mm

Suggested Pad Layout

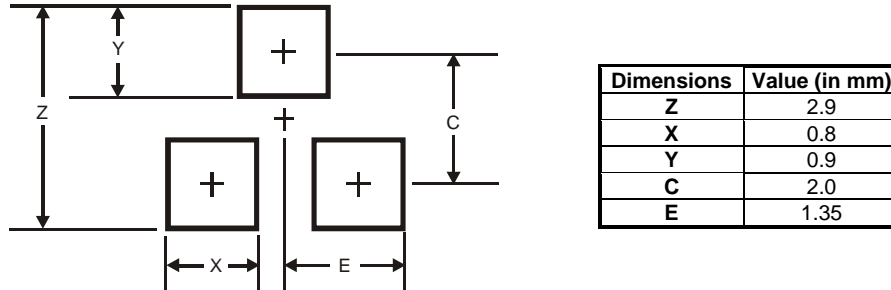

IMPORTANT NOTICE

DIODES INCORPORATED MAKES NO WARRANTY OF ANY KIND, EXPRESS OR IMPLIED, WITH REGARDS TO THIS DOCUMENT, INCLUDING, BUT NOT LIMITED TO, THE IMPLIED WARRANTIES OF MERCHANTABILITY AND FITNESS FOR A PARTICULAR PURPOSE (AND THEIR EQUIVALENTS UNDER THE LAWS OF ANY JURISDICTION).

Diodes Incorporated and its subsidiaries reserve the right to make modifications, enhancements, improvements, corrections or other changes without further notice to this document and any product described herein. Diodes Incorporated does not assume any liability arising out of the application or use of this document or any product described herein; neither does Diodes Incorporated convey any license under its patent or trademark rights, nor the rights of others. Any Customer or user of this document or products described herein in such applications shall assume all risks of such use and will agree to hold Diodes Incorporated and all the companies whose products are represented on Diodes Incorporated website, harmless against all damages.

Diodes Incorporated does not warrant or accept any liability whatsoever in respect of any products purchased through unauthorized sales channel. Should Customers purchase or use Diodes Incorporated products for any unintended or unauthorized application, Customers shall indemnify and hold Diodes Incorporated and its representatives harmless against all claims, damages, expenses, and attorney fees arising out of, directly or indirectly, any claim of personal injury or death associated with such unintended or unauthorized application.

Products described herein may be covered by one or more United States, international or foreign patents pending. Product names and markings noted herein may also be covered by one or more United States, international or foreign trademarks.

LIFE SUPPORT

Diodes Incorporated products are specifically not authorized for use as critical components in life support devices or systems without the express written approval of the Chief Executive Officer of Diodes Incorporated. As used herein:

A. Life support devices or systems are devices or systems which:

1. are intended to implant into the body, or
2. support or sustain life and whose failure to perform when properly used in accordance with instructions for use provided in the labeling can be reasonably expected to result in significant injury to the user.

B. A critical component is any component in a life support device or system whose failure to perform can be reasonably expected to cause the failure of the life support device or to affect its safety or effectiveness.

Customers represent that they have all necessary expertise in the safety and regulatory ramifications of their life support devices or systems, and acknowledge and agree that they are solely responsible for all legal, regulatory and safety-related requirements concerning their products and any use of Diodes Incorporated products in such safety-critical, life support devices or systems, notwithstanding any devices- or systems-related information or support that may be provided by Diodes Incorporated. Further, Customers must fully indemnify Diodes Incorporated and its representatives against any damages arising out of the use of Diodes Incorporated products in such safety-critical, life support devices or systems.

Copyright © 2011, Diodes Incorporated

www.diodes.com