

CW series

Proportional miniature control wheel

Distinctive features and specifications



- Miniature design
- Ideal for joystick, armrest and panel mounting
- Proportional output
- Self-centering, single axis actuator
- Snap-in mounting

MECHANICAL	ELECTRICAL
<ul style="list-style-type: none"> • Mechanical Angle of Movement: $\pm 45^\circ$ • Expected Life: 3 million cycles • Mass / weight: $18.25\text{g} \pm 5.0\text{g}$ ($0.64\text{oz} \pm 0.18\text{oz}$) • Lever Action (Centering): Spring centering 	<ul style="list-style-type: none"> • Resolution: 1.22mV • Supply Voltage Range: $5.00\text{V} \pm 0.250\text{VDC}$ • Reverse Polarity Max: -10V • Overvoltage Max: 20V • Output Impedance: 2Ω • Return to Center Voltage Tolerance: $\pm 200\text{mV}$ initial
ENVIRONMENTAL	<p>NOTES: Exact specifications are subject to configuration. All values are nominal.</p>
<ul style="list-style-type: none"> • Operating Temperature: -40°C to $+85^\circ\text{C}$ (-40°F to $+185^\circ\text{F}$) • Storage Temperature: -40°C to $+85^\circ\text{C}$ (-40°F to $+185^\circ\text{F}$) • EMC Immunity Level: EN61000-4-3 • EMC Emissions Level: EN61000-6-3:2001 • ESD: EN61000-4-2 	

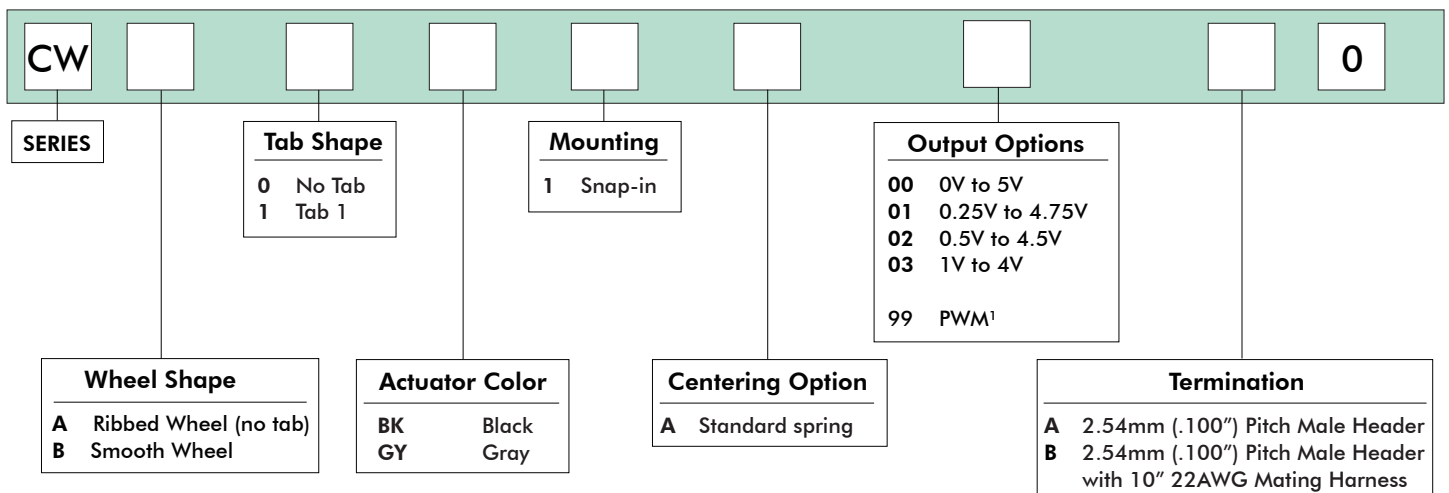

NOTE:

1 - Contact factory for PWM configuration.

CW series

Proportional miniature control wheel

Overview

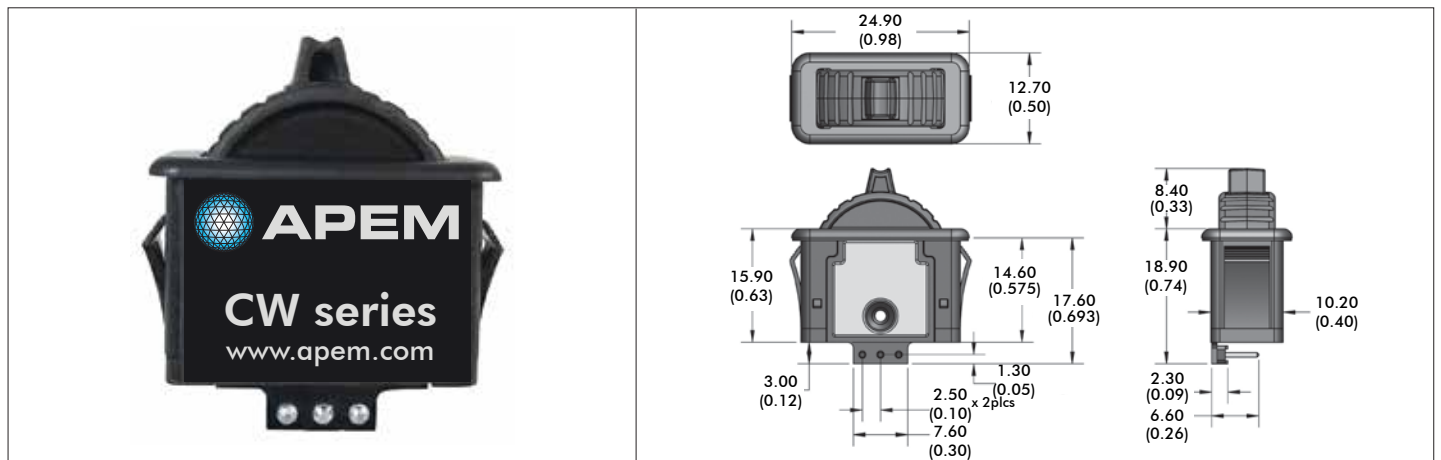

MOUNTING OPTIONS

PANEL CUTOUT

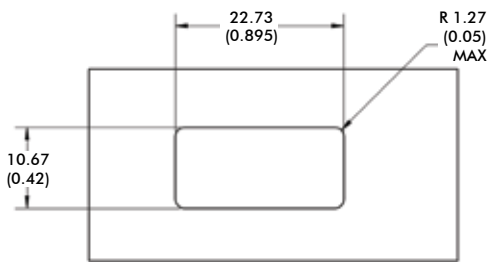

PANEL THICKNESS

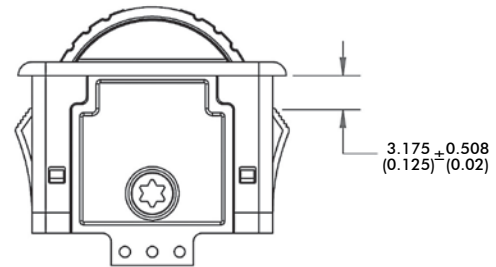

NOTE: Dimensions are in mm/(inch).

VOLTAGE OUTPUT OPTIONS

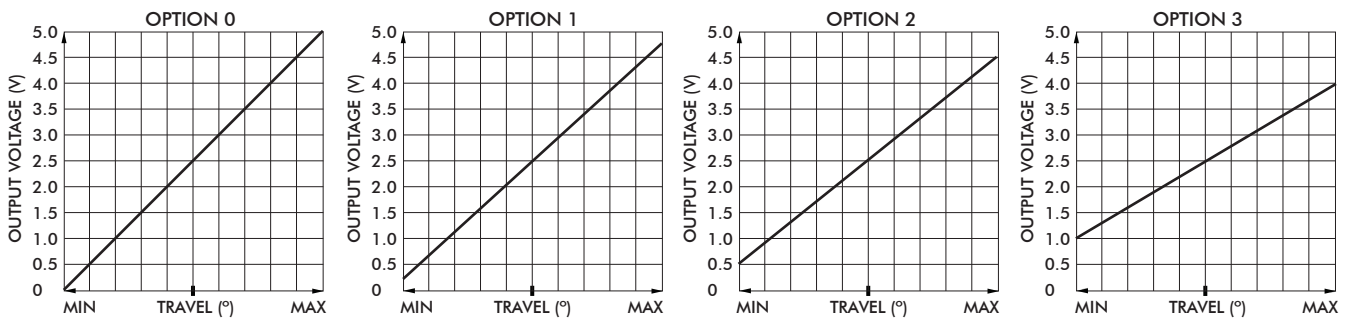

TERMINALS

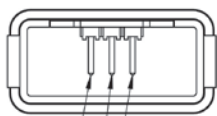

Pin 1 - 5V power (RED)
Pin 2 - Ground (BLACK)
Pin 3 - Signal (BLUE)

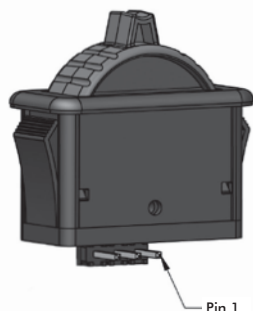

OPTIONAL MATING HARNESS¹

- Wire type: 22AWG 25cm PTFE
- Connector: Molex 0050579503

WIRING SPECIFICATION

- Red: Power (5V)
- Black: Ground
- Blue: Signal

NOTES:

1. The CW Series is fitted with a three terminal SAMTEC (TLW-103-05-T-S) 2.54mm header. An optional 22AWG Mating Harness may be specified from the "Terminal" category of the Option Selection Guide.
- Images shown are for illustration purposes only.

Note: The company reserves the right to change specifications without notice.