

HiPerFAST™ IGBT

IXGH 15N120B
IXGT 15N120B

$V_{CES} = 1200 \text{ V}$
 $I_{C25} = 30 \text{ A}$
 $V_{CE(sat)} = 3.2 \text{ V}$
 $t_{fi(typ)} = 160 \text{ ns}$

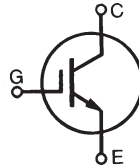

Symbol	Test Conditions	Maximum Ratings	
V_{CES}	$T_J = 25^\circ\text{C to } 150^\circ\text{C}$	1200	V
V_{CGR}	$T_J = 25^\circ\text{C to } 150^\circ\text{C}; R_{GE} = 1 \text{ M}\Omega$	1200	V
V_{GES}	Continuous	± 20	V
V_{GEM}	Transient	± 30	V
I_{C25}	$T_C = 25^\circ\text{C}$	30	A
I_{C110}	$T_C = 110^\circ\text{C}$	15	A
I_{CM}	$T_C = 25^\circ\text{C}, 1 \text{ ms}$	60	A
SSOA (RBSOA)	$V_{GE} = 15 \text{ V}, T_{VJ} = 125^\circ\text{C}, R_G = 10 \Omega$ Clamped inductive load	$I_{CM} = 40$ @ $0.8 V_{CES}$	A
P_C	$T_C = 25^\circ\text{C}$	180	W
T_J		-55 ... +150	$^\circ\text{C}$
T_{JM}		150	$^\circ\text{C}$
T_{stg}		-55 ... +150	$^\circ\text{C}$
Maximum Lead temperature for soldering		300	$^\circ\text{C}$
1.6 mm (0.062 in.) from case for 10 s			
Maximum Tab temperature for soldering SMD devices for 10 s		260	$^\circ\text{C}$
M_d	Mounting torque (M3)	1.13/10Nm/lb.in.	
Weight	TO-247 AD	6	g
	TO-268	4	g

TO-268 (IXGT)

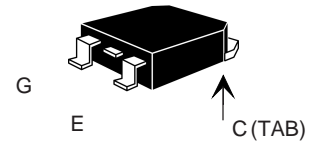

TO-247 AD (IXGH)

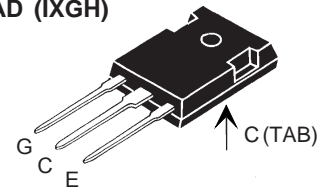

G = Gate, C = Collector,
E = Emitter, TAB = Collector

Features

- International standard packages JEDEC TO-268 surface and JEDEC TO-247 AD
- Low switching losses, low $V_{(sat)}$
- MOS Gate turn-on - drive simplicity

Applications

- AC motor speed control
- DC servo and robot drives
- DC choppers
- Uninterruptible power supplies (UPS)
- Switched-mode and resonant-mode power supplies

Advantages

- High power density
- Suitable for surface mounting
- Easy to mount with 1 screw, (isolated mounting screw hole)

Symbol	Test Conditions	Characteristic Values ($T_J = 25^\circ\text{C}$, unless otherwise specified)		
		min.	typ.	max.
BV_{CES}	$I_C = 250 \mu\text{A}, V_{GE} = 0 \text{ V}$	1200		V
$V_{GE(th)}$	$I_C = 250 \mu\text{A}, V_{CE} = V_{GE}$	2.5		V
I_{CES}	$V_{CE} = V_{CES}$ $V_{GE} = 0 \text{ V}$	$T_J = 25^\circ\text{C}$		100 μA
		$T_J = 125^\circ\text{C}$		3.5 mA
I_{GES}	$V_{CE} = 0 \text{ V}, V_{GE} = \pm 20 \text{ V}$			$\pm 100 \text{ nA}$
$V_{CE(sat)}$	$I_C = I_{C90}, V_{GE} = 15 \text{ V}$		2.5	3.2 V
				V

Symbol	Test Conditions	Characteristic Values ($T_J = 25^\circ\text{C}$, unless otherwise specified)			
		min.	typ.	max.	
g_{fs}	$I_C = I_{C110}; V_{CE} = 10\text{ V}$, Pulse test, $t \leq 300\ \mu\text{s}$, duty cycle $\leq 2\%$	12	15	S	
C_{ies}	$V_{CE} = 25\text{ V}, V_{GE} = 0\text{ V}, f = 1\text{ MHz}$		1720	pF	
C_{oes}			95	pF	
C_{res}			35	pF	
Q_g	$I_C = I_{C110}, V_{GE} = 15\text{ V}, V_{CE} = 0.5 V_{CES}$		69	nC	
Q_{ge}			13	nC	
Q_{gc}			26	nC	
$t_{d(on)}$	Inductive load, $T_J = 25^\circ\text{C}$ $I_C = I_{C110}, V_{GE} = 15\text{ V}$ $V_{CE} = 0.8 V_{CES}, R_G = R_{off} = 10\ \Omega$ Remarks: Switching times may increase for $V_{CE}(\text{Clamp}) > 0.8 \cdot V_{CES}$, higher T_J or increased R_G		25	ns	
t_{ri}			15	ns	
$t_{d(off)}$			180	280	ns
t_{fi}			160	320	ns
E_{off}			1.75	3.0	mJ
$t_{d(on)}$	Inductive load, $T_J = 125^\circ\text{C}$ $I_C = I_{C110}, V_{GE} = 15\text{ V}$ $V_{CE} = 0.8 V_{CES}, R_G = R_{off} = 10\ \Omega$ Remarks: Switching times may increase for $V_{CE}(\text{Clamp}) > 0.8 \cdot V_{CES}$, higher T_J or increased R_G		25	ns	
t_{ri}			18	ns	
E_{on}			0.60		mJ
$t_{d(off)}$			300		ns
t_{fi}			360		ns
E_{off}		3.5		mJ	
R_{thJC}				0.65 K/W	
R_{thCK}	(TO-247)		0.25	K/W	

Min Recommended Footprint

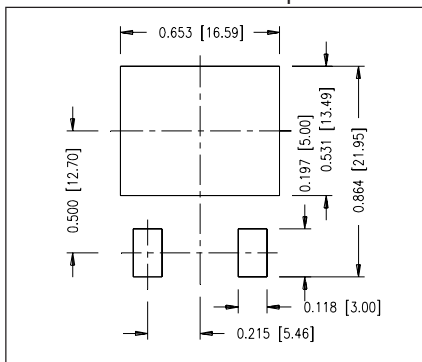

TO-247 AD Outline

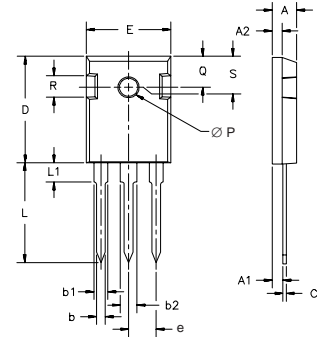

Dim.	Millimeter		Inches	
	Min.	Max.	Min.	Max.
A	4.7	5.3	.185	.209
A ₁	2.2	2.54	.087	.102
A ₂	2.2	2.6	.059	.098
b	1.0	1.4	.040	.055
b ₁	1.65	2.13	.065	.084
b ₂	2.87	3.12	.113	.123
C	.4	.8	.016	.031
D	20.80	21.46	.819	.845
E	15.75	16.26	.610	.640
e	5.20	5.72	0.205	0.225
L	19.81	20.32	.780	.800
L1		4.50		.177
∅P	3.55	3.65	.140	.144
Q	5.89	6.40	0.232	0.252
R	4.32	5.49	.170	.216
S	6.15	BSC	242	BSC

TO-268 Outline

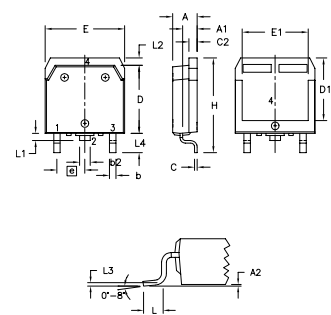

Dim.	Millimeter		Inches	
	Min.	Max.	Min.	Max.
A	4.9	5.1	.193	.201
A ₁	2.7	2.9	.106	.114
A ₂	.02	.25	.001	.010
b	1.15	1.45	.045	.057
b ₁	1.9	2.1	.75	.83
C	.4	.65	.016	.026
D	13.80	14.00	.543	.551
E	15.85	16.05	.624	.632
E ₁	13.3	13.6	.524	.535
e	5.45	BSC	.215	BSC
H	18.70	19.10	.736	.752
L	2.40	2.70	.094	.106
L1	1.20	1.40	.047	.055
L2	1.00	1.15	.039	.045
L3		0.25		.010 BSC
L4	3.80	4.10	.150	.161

IXYS reserves the right to change limits, test conditions, and dimensions.

IXYS MOSFETs and IGBTs are covered by one or more of the following U.S. patents:

4,835,592	4,881,106	5,017,508	5,049,961	5,187,117	5,486,715	6,306,728B1
4,850,072	4,931,844	5,034,796	5,063,307	5,237,481	5,381,025	

Fig. 1. Saturation Voltage Characteristics @ 25°C

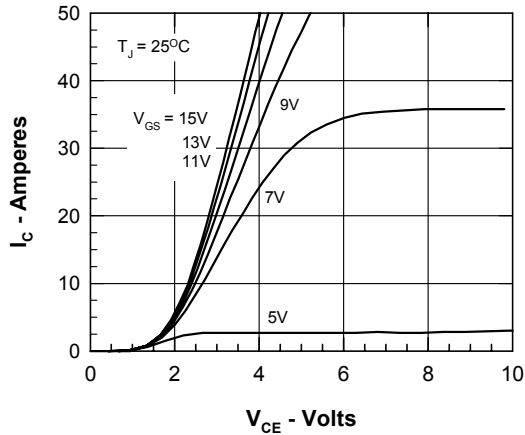

Fig. 2. Extended Output Characteristics

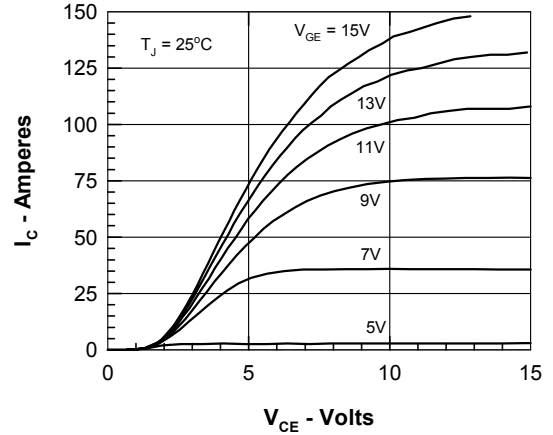

Fig. 3. Saturation Voltage Characteristics @ 125°C

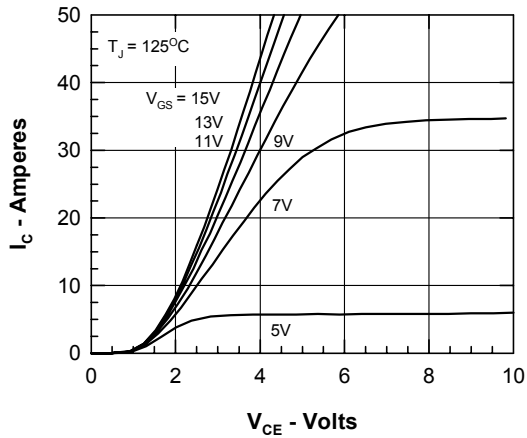

Fig. 4. Temperature Dependence of $V_{CE(SAT)}$

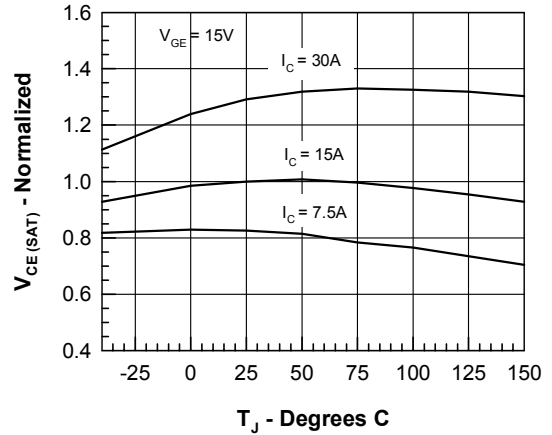

Fig. 5. Admittance Curves

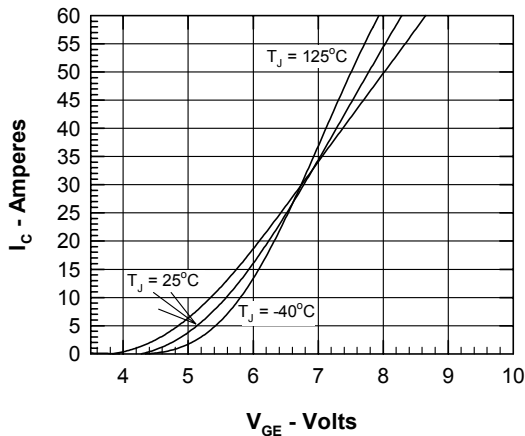

Fig. 6. Capacitance Curves

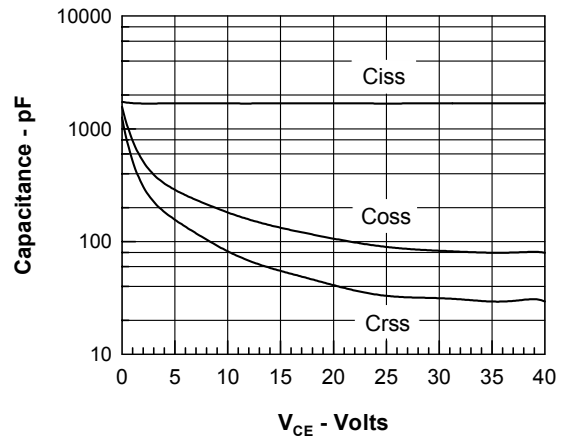

Fig. 7. Dependence of E_{OFF} on I_C .

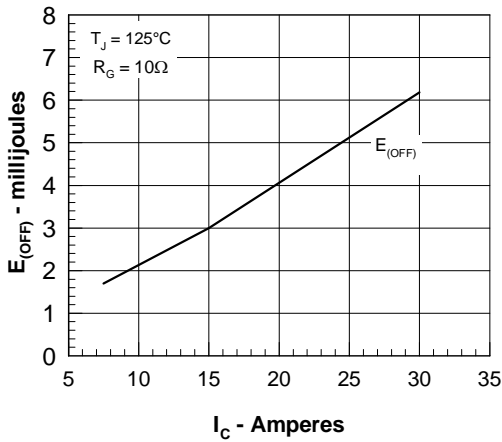

Fig. 8. Dependence of E_{OFF} on R_G .

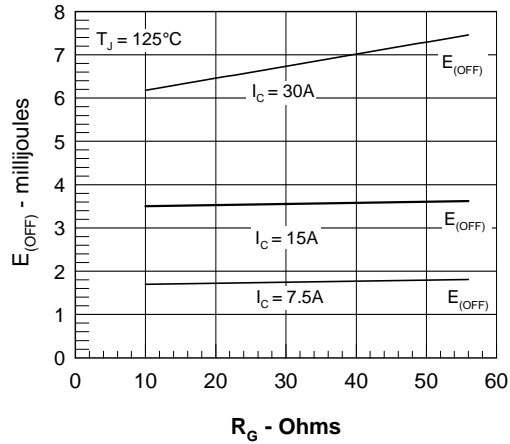

Fig. 9. Gate Charge

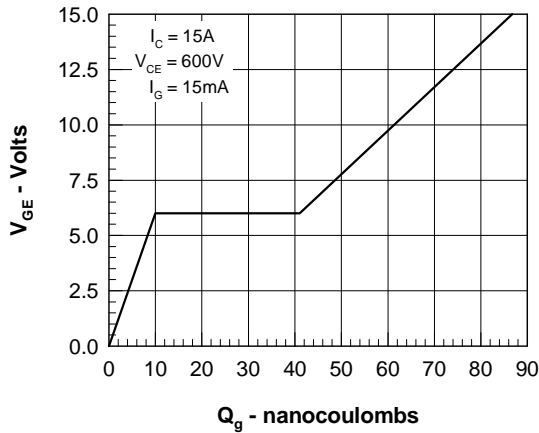

Fig. 10. Turn-off Safe Operating Area

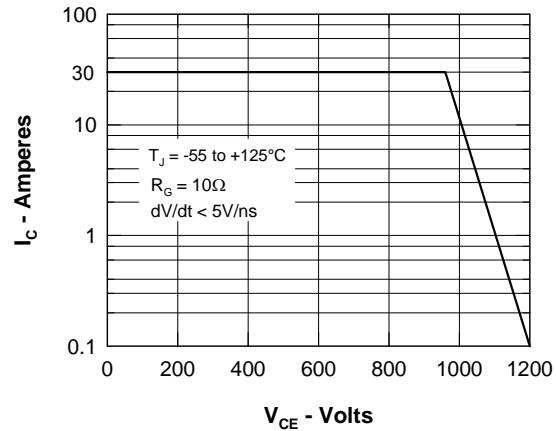

Fig. 11. Thermal Impedance

