

# PXAC203302FV

## Thermally-Enhanced High Power RF LDMOS FET 330 W, 28 V, 1880 – 2025 MHz

### Description

The PXAC203302FV is a 330-watt LDMOS FET with an asymmetrical design intended for use in multi-standard cellular power amplifier applications in the 1880 to 2025 MHz frequency band. Features include dual-path design, input matching, high gain and thermally-enhanced package with earless flanges. Manufactured with Wolfspeed's advanced LDMOS process, this device provides excellent thermal performance and superior reliability.

PXAC203302FV  
Package H-37275-4

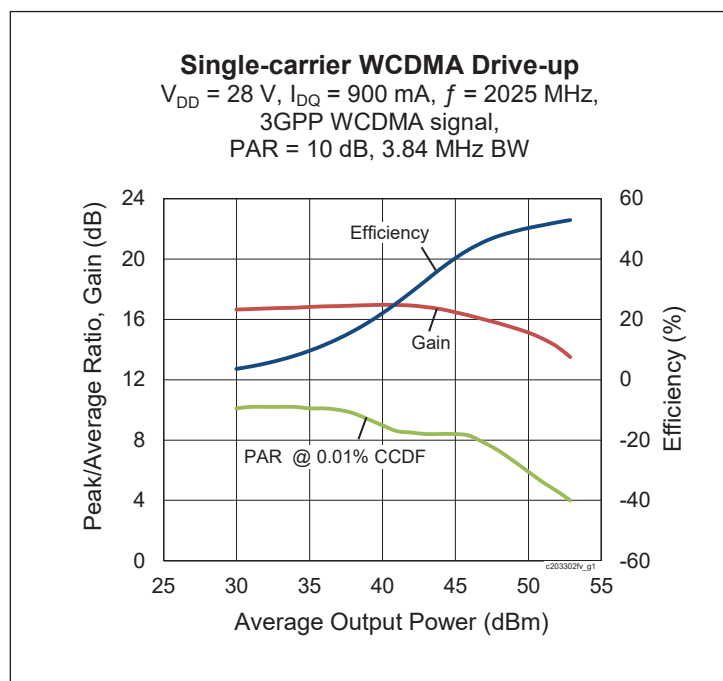
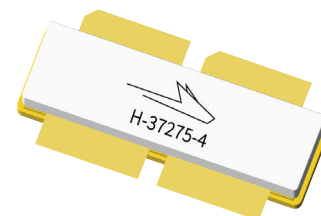

### Features

- Broadband internal input and output matching
- Asymmetrical Doherty design
  - Main :  $P_{1dB} = 130\text{ W Typ}$
  - Peak :  $P_{1dB} = 200\text{ W Typ}$
- Typical Pulsed CW performance, 2025 MHz, 28 V, combined outputs, Doherty Configuration
  - Output power at  $P_{1dB} = 250\text{ W}$
  - Efficiency = 55%
  - Gain = 16 dB
- Capable of handling 10:1 VSWR @ 28 V, 250 W (CW) output power
- Human Body Model Class 2 (per ANSI/ESDA/ JEDEC JS-001)
- Integrated ESD protection
- Low thermal resistance
- Pb-free and RoHS compliant

### RF Characteristics

#### Single-carrier WCDMA Specifications (tested in Wolfspeed Doherty test fixture)

$V_{DD} = 28\text{ V}$ ,  $I_{DQ} = 900\text{ mA}$ ,  $V_{GSPEAK} = 1.1\text{ V}$ ,  $P_{OUT} = 56\text{ W avg}$ ,  $f_1 = 2025\text{ MHz}$ , 3GPP signal, channel bandwidth = 3.84MHz, peak/average = 10 dB @ 0.01% CCDF

Characteristic	Symbol	Min	Typ	Max	Unit
Gain	$G_{ps}$	15	16	—	dB
Drain Efficiency	$\eta_D$	45	49	—	%
Adjacent Channel Power Ratio	ACPR	—	-30.5	-26	dBc

All published data at  $T_{CASE} = 25^\circ\text{C}$  unless otherwise indicated

ESD: Electrostatic discharge sensitive device—observe handling precautions!

**DC Characteristics** (each side)

Characteristic	Conditions	Symbol	Min	Typ	Max	Unit
Drain-Source Breakdown Voltage	$V_{GS} = 0\text{ V}, I_{DS} = 10\text{ mA}$	$V_{(BR)DSS}$	65	—	—	V
Drain Leakage Current	$V_{DS} = 28\text{ V}, V_{GS} = 0\text{ V}$	$I_{DSS}$	—	—	1	$\mu\text{A}$
	$V_{DS} = 63\text{ V}, V_{GS} = 0\text{ V}$	$I_{DSS}$	—	—	10	$\mu\text{A}$
On-State Resistance (main)	$V_{GS} = 10\text{ V}, V_{DS} = 0.1\text{ V}$	$R_{DS(on)}$	—	0.088	—	$\Omega$
	(peak) $V_{GS} = 10\text{ V}, V_{DS} = 0.1\text{ V}$	$R_{DS(on)}$	—	0.088	—	$\Omega$
Operating Gate Voltage (main)	$V_{DS} = 28\text{ V}, I_{DQ} = 900\text{ mA}$	$V_{GS}$	2.5	2.7	2.8	V
	(peak) $V_{DS} = 28\text{ V}, I_{DQ} = 0\text{ A}$	$V_{GS}$	0.6	1.1	1.4	V
Gate Leakage Current	$V_{GS} = 10\text{ V}, V_{DS} = 0\text{ V}$	$I_{GSS}$	—	—	1	$\mu\text{A}$

**Maximum Ratings**

Parameter	Symbol	Value	Unit
Drain-Source Voltage	$V_{DSS}$	65	V
Gate-Source Voltage	$V_{GS}$	-6 to +10	V
Operating Voltage	$V_{DD}$	0 to +32	V
Junction Temperature	$T_J$	225	$^{\circ}\text{C}$
Storage Temperature Range	$T_{STG}$	-65 to +150	$^{\circ}\text{C}$
Thermal Resistance (main, $T_{CASE} = 70^{\circ}\text{C}$ , 56.2 W CW)	$R_{\theta JC}$	0.62	$^{\circ}\text{C/W}$
	(peak, $T_{CASE} = 70^{\circ}\text{C}$ , 260 W CW)	$R_{\theta JC}$	0.35

**Ordering Information**

Type and Version	Order Code	Package Description	Shipping
PXAC203302FV V1 R0	PXAC203302FV-V1-R0	H-37275-4, earless flange	Tape & Reel, 50 pcs
PXAC203302FV V1 R250	PXAC203302FV-V1-R250	H-37275-4, earless flange	Tape & Reel, 250 pcs

**Typical Performance** (data taken in a production test fixture)

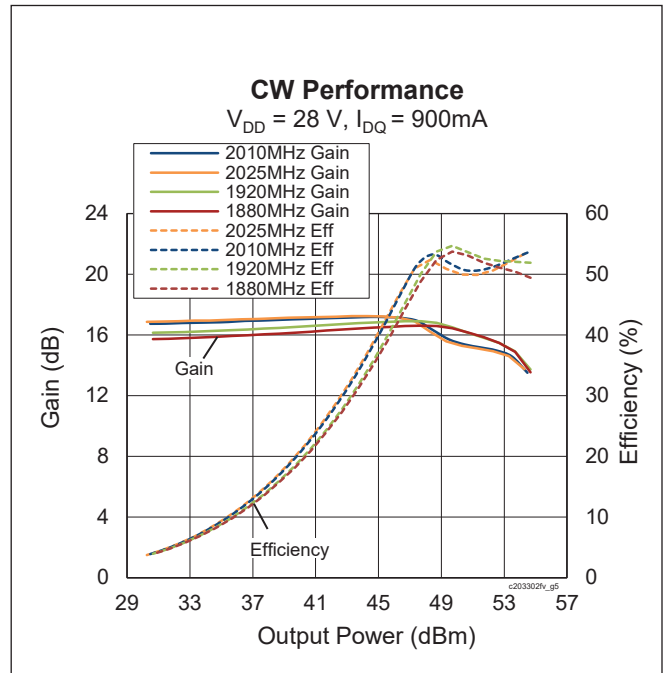
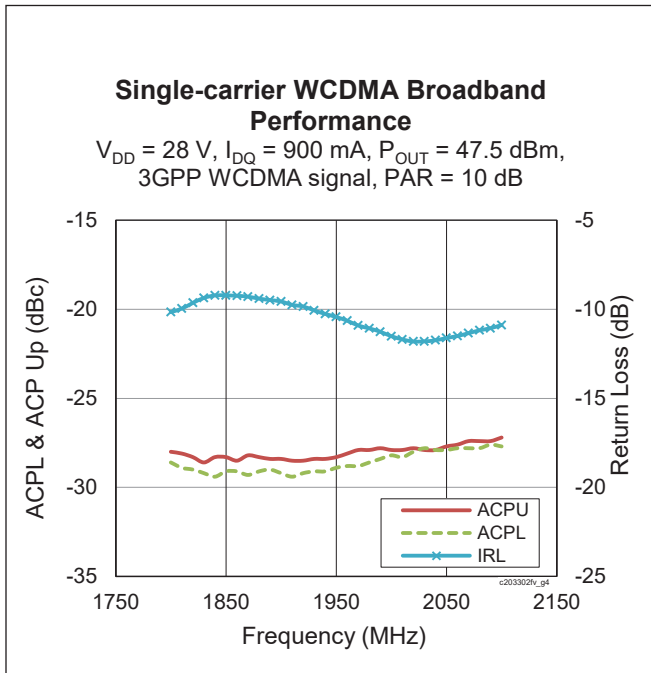
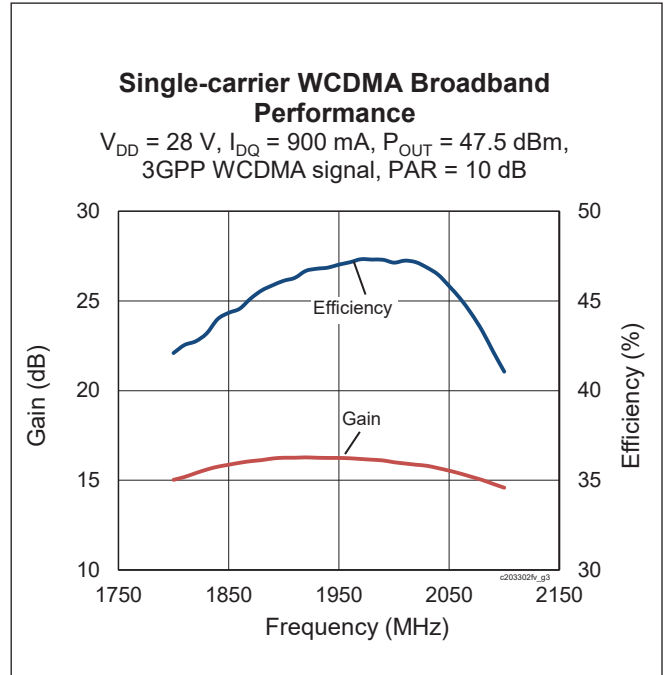
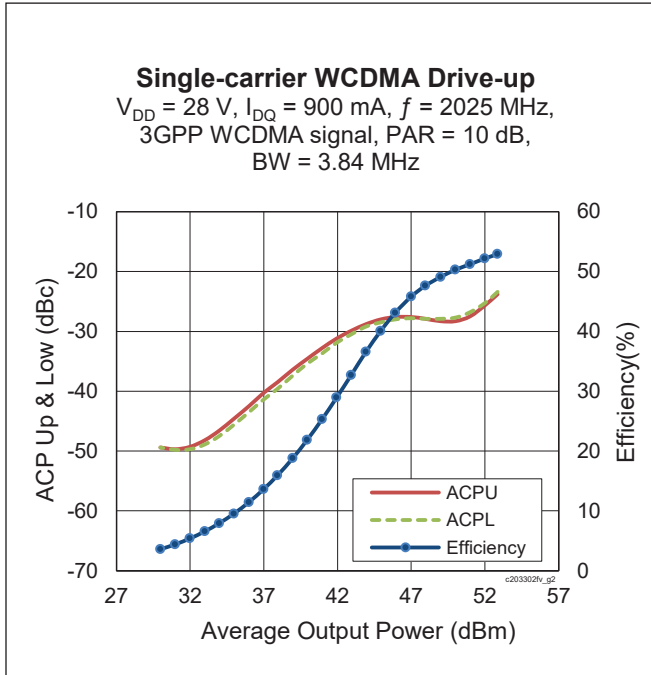

Typical Performance (cont.)

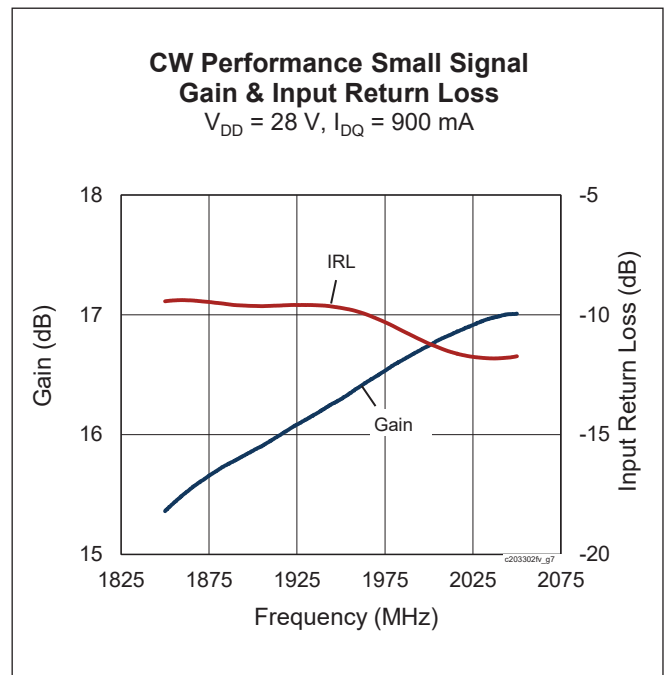
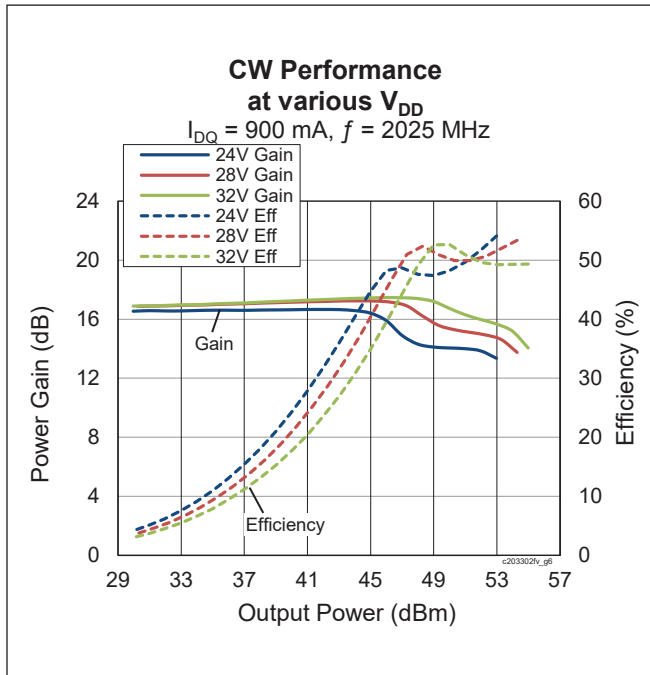

Load Pull Performance

Main Side Load Pull Performance – Pulsed CW signal: 160  $\mu\text{s}$ , 10% duty cycle, 28 V,  $I_{DQ} = 800 \text{ mA}$ , Class AB

Freq [MHz]	$Z_s$ [ $\Omega$ ]	$P_{1dB}$									
		Max Output Power					Max Drain Efficiency				
		$Z_l$ [ $\Omega$ ]	Gain [dB]	$P_{OUT}$ [dBm]	$P_{OUT}$ [W]	$\eta_D$ [%]	$Z_l$ [ $\Omega$ ]	Gain [dB]	$P_{OUT}$ [dBm]	$P_{OUT}$ [W]	$\eta_D$ [%]
1880	2.78 - j6.42	1.33 - j2.33	18.5	52.5	179	55.1	3.40 - j1.31	21.2	50.0	100	66.7
1900	2.94 - j6.93	1.31 - j2.40	18.5	52.5	176	54.4	2.82 - j1.21	21.2	50.1	102	65.5
1920	3.81 - j7.27	1.30 - j2.46	18.5	52.4	174	53.8	2.61 - j1.25	21.0	50.4	108	65.6
2010	6.13 - j8.11	1.17 - j2.61	18.4	52.1	164	50.6	2.19 - j1.29	21.2	50.0	100	63.2
2025	8.73 - j8.92	1.29 - j2.65	18.8	52.2	168	53.9	2.19 - j1.35	21.2	50.1	101	62.9

Peak Side Load Pull Performance – Pulsed CW signal: 160  $\mu\text{s}$ , 10% duty cycle, 28 V,  $V_{GS} = 1.4 \text{ V}$ , Class C

Freq [MHz]	$Z_s$ [ $\Omega$ ]	$P_{1dB}$									
		Max Output Power					Max Drain Efficiency				
		$Z_l$ [ $\Omega$ ]	Gain [dB]	$P_{OUT}$ [dBm]	$P_{OUT}$ [W]	$\eta_D$ [%]	$Z_l$ [ $\Omega$ ]	Gain [dB]	$P_{OUT}$ [dBm]	$P_{OUT}$ [W]	$\eta_D$ [%]
1880	1.47 - j3.68	2.40 - j2.40	15.4	54.0	250	54.8	1.69 - j0.40	16.5	52.0	159	65.4
1900	1.52 - j4.02	2.08 - j2.31	15.8	54.0	249	55.8	1.58 - j0.55	16.9	52.1	164	66.9
1920	1.54 - j4.21	2.29 - j2.39	15.9	53.9	247	55.6	1.44 - j0.58	17.0	51.9	156	66.7
2010	2.84 - j4.51	2.51 - j2.67	16.1	53.7	236	54.5	1.50 - j1.19	17.2	52.1	162	64.3
2025	4.34 - j5.13	2.68 - j2.58	16.4	53.8	192	55.2	1.37 - j1.22	17.3	51.9	155	64.6



### Reference Circuit , 1880 – 2025 MHz

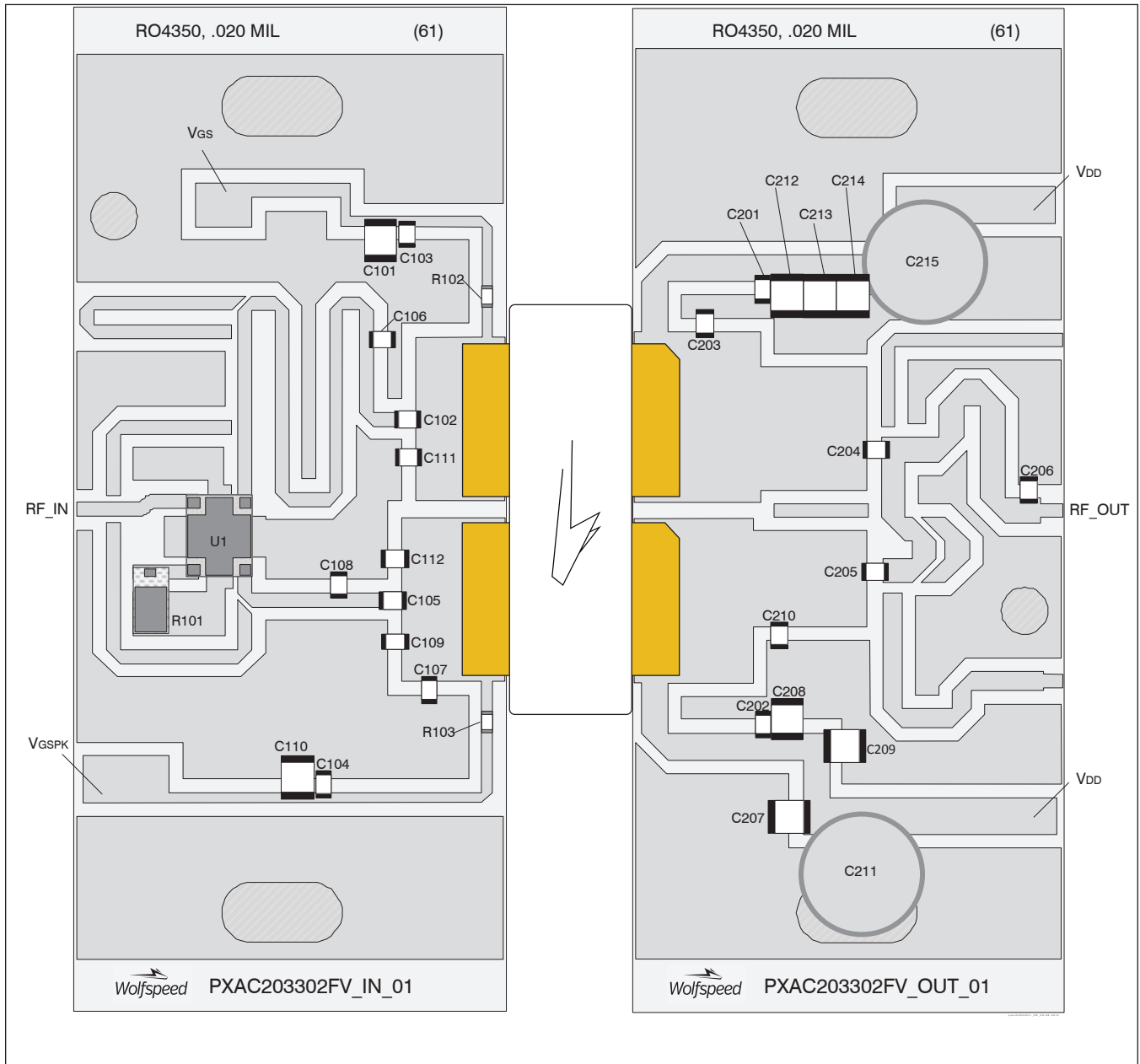

Reference circuit assembly diagram (not to scale)



**Reference Circuit** (cont.)

**Reference Circuit Assembly**

DUT	PXAC203302FV-V1
Test Fixture Part No.	LTA/PXAC203302FV-V1
PCB	Rogers 4350, 0.508 mm [0.020"] thick, 2 oz. copper, $\epsilon_r = 3.66$ , $f = 1880 - 2025$ MHz
Find Gerber files for this test fixture on the Wolfspeed Web site at <a href="http://www.wolfspeed.com/RF">http://www.wolfspeed.com/RF</a>	

**Components Information**

Component	Description	Manufacturer	P/N
<b>Input</b>			
C101, C110	Capacitor, 10 $\mu$ F	Taiyo Yuden	UMK325C7106MM-T
C102, C103, C104, C105	Capacitor, 15 pF	ATC	ATC600F150JT250XT
C106, C111	Capacitor, 1 pF	ATC	ATC600F1R0BT250XT
C107	Capacitor, 2.7 pF	ATC	ATC600F2R7BT250XT
C108	Capacitor, 1.6 pF	ATC	ATC600F1R6BT250XT
C109	Capacitor, 0.5 pF	ATC	ATC600F0R5BT250XT
C112	Capacitor, 0.8 pF	ATC	ATC600F0R8BT250XT
R101, R102	Resistor, 10 $\Omega$	Panasonic Electronic Components	ERJ-3GEYJ100V
R103	Resistor, 50 $\Omega$	Richardson	C16A50Z4
U1	Hybrid Coupler	Anaren	X3C19P1-05S
<b>Output</b>			
C201, C202	Capacitor, 15 pF	ATC	ATC600F150JT250XT
C203	Capacitor, 1.6 pF	ATC	ATC600F1R6BT250XT
C204, C205	Capacitor, 6.8 pF	ATC	ATC600F6R8BT250XT
C206	Capacitor, 0.3 pF	ATC	ATC600F0R3BT250XT
C207, C208, C209, C212, C213, C214	Capacitor, 10 $\mu$ F	Taiyo Yuden	UMK325C7106MM-T
C210	Capacitor, 0.5 pF	ATC	ATC600F0R5BT250XT
C211, C215	Capacitor, 220 $\mu$ F	Cornell Dubilier Electronics (CDE)	SK221M050ST

**Pinout Diagram** (top view)

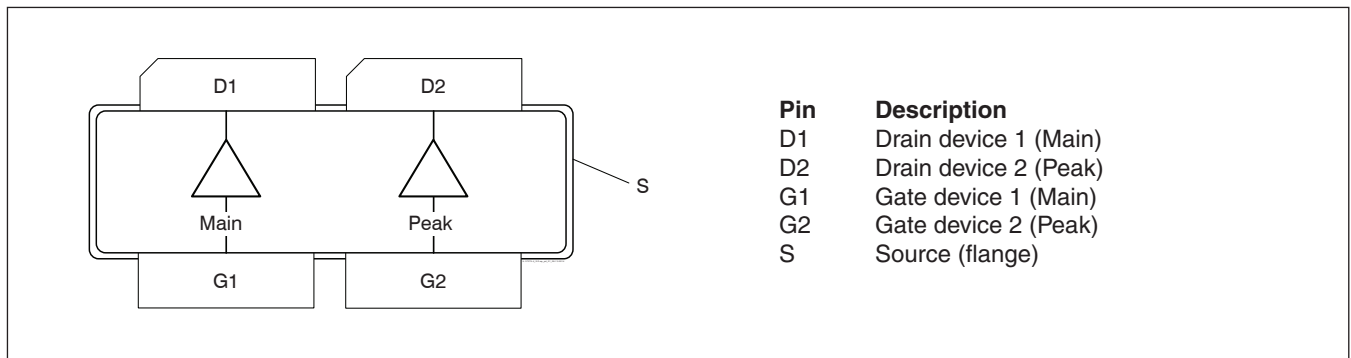

Lead connections for PXAC203302FV

Package Outline Specifications

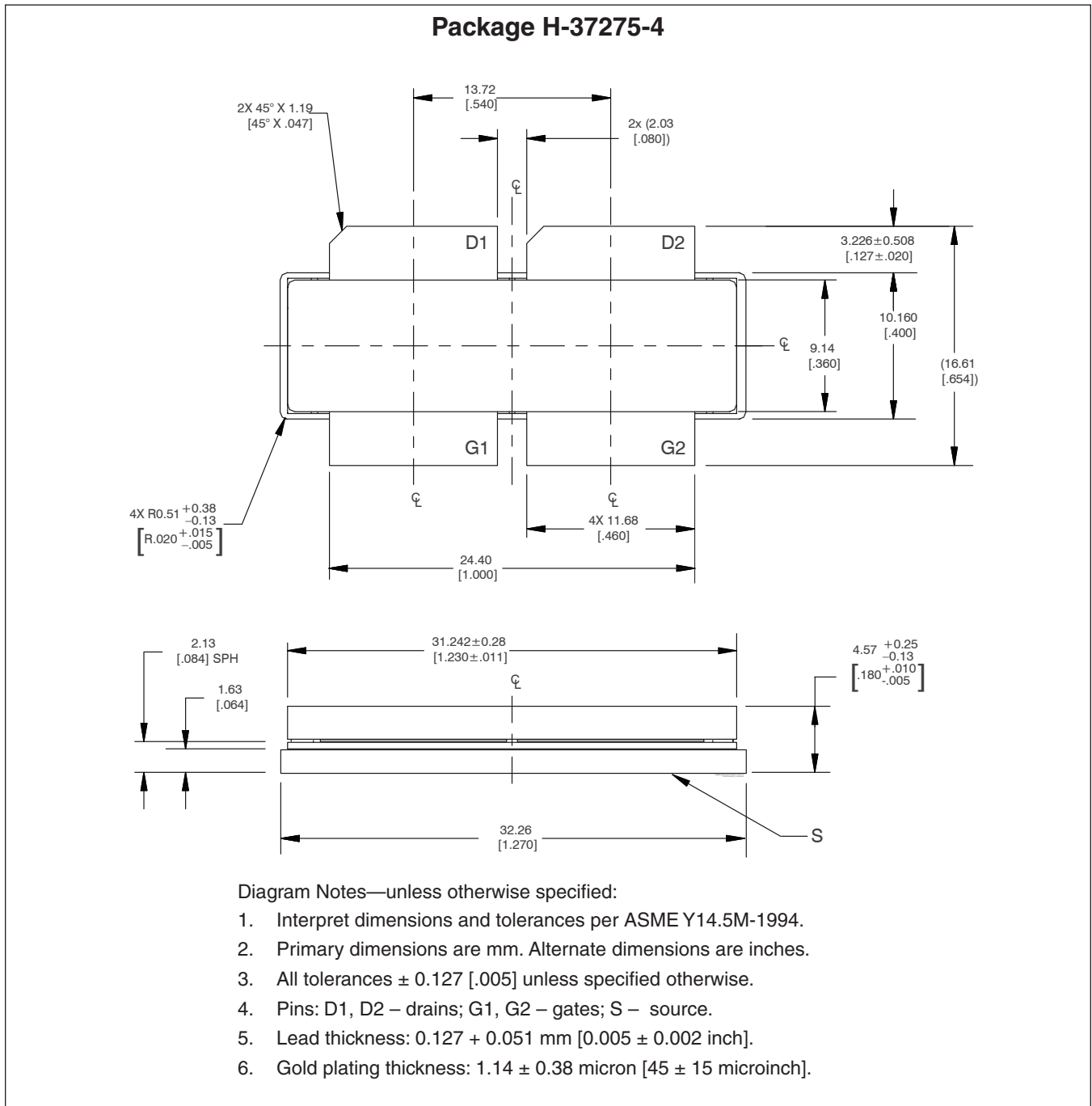

## Revision History

Revision	Date	Data Sheet Type	Page	Subjects (major changes since last revision)
01	2014-03-03	Advance	All	Proposed specification for new product development.
02	2014-06-12	Production	All	Specification for production-released device.
02.1	2014-06-30	Production	1	Corrected typo in features.
02.2	2016-06-22	Production	2	Updated ordering information
03	2018-07-02	Production	All	Converted to Wolfspeed Data Sheet
03.1	2018-11-08	Production	6	Corrected test fixture part no.

For more information, please contact:

4600 Silicon Drive  
 Durham, North Carolina, USA 27703  
[www.wolfspeed.com/RF](http://www.wolfspeed.com/RF)

Sales Contact  
[RFSales@wolfspeed.com](mailto:RFSales@wolfspeed.com)

RF Product Marketing Contact  
[RFMarketing@wolfspeed.com](mailto:RFMarketing@wolfspeed.com)  
 919.407.7816

## Notes

---

### Disclaimer

Specifications are subject to change without notice. Cree, Inc. believes the information contained within this data sheet to be accurate and reliable. However, no responsibility is assumed by Cree for any infringement of patents or other rights of third parties which may result from its use. No license is granted by implication or otherwise under any patent or patent rights of Cree. Cree makes no warranty, representation or guarantee regarding the suitability of its products for any particular purpose. "Typical" parameters are the average values expected by Cree in large quantities and are provided for information purposes only. These values can and do vary in different applications and actual performance can vary over time. All operating parameters should be validated by customer's technical experts for each application. Cree products are not designed, intended or authorized for use as components in applications intended for surgical implant into the body or to support or sustain life, in applications in which the failure of the Cree product could result in personal injury or death or in applications for planning, construction, maintenance or direct operation of a nuclear facility.