



## OD1232 Series

DC Fan - 12V, 24V, 48V  
120 x 32mm (4.7.62 x 1.25in)



Model #	Pg #	Voltage	RPM	CFM	Noise Level	Max Static Pressure
OD1232-12H	2	12 VDC	3750	120	51 dB	.42 H <sub>2</sub> O
OD1232-12M	2	12 VDC	3300	107	48 dB	.33 H <sub>2</sub> O
OD1232-12L	2	12 VDC	2900	93	44 dB	.27 H <sub>2</sub> O
OD1232-24H	2	24 VDC	3750	120	51 dB	.42 H <sub>2</sub> O
OD1232-24M	2	24 VDC	3300	107	48 dB	.33 H <sub>2</sub> O
OD1232-24L	2	24 VDC	2900	93	44 dB	.27 H <sub>2</sub> O
OD1232-48H	2	48 VDC	3750	120	51 dB	.42 H <sub>2</sub> O
OD1232-48M	2	48 VDC	3300	107	48 dB	.33 H <sub>2</sub> O
OD1232-48L	2	48 VDC	2900	93	44 dB	.27 H <sub>2</sub> O
OD1232-24MB02A	3	24 VDC	3300	107	48 dB	.33 H <sub>2</sub> O
OD1232-48MB02A	4	48 VDC	3300	107	48 dB	.33 H <sub>2</sub> O

# OD1232 Series



DC Fan - 12, 24, 48V  
120x32mm (4.7"x 1.25")

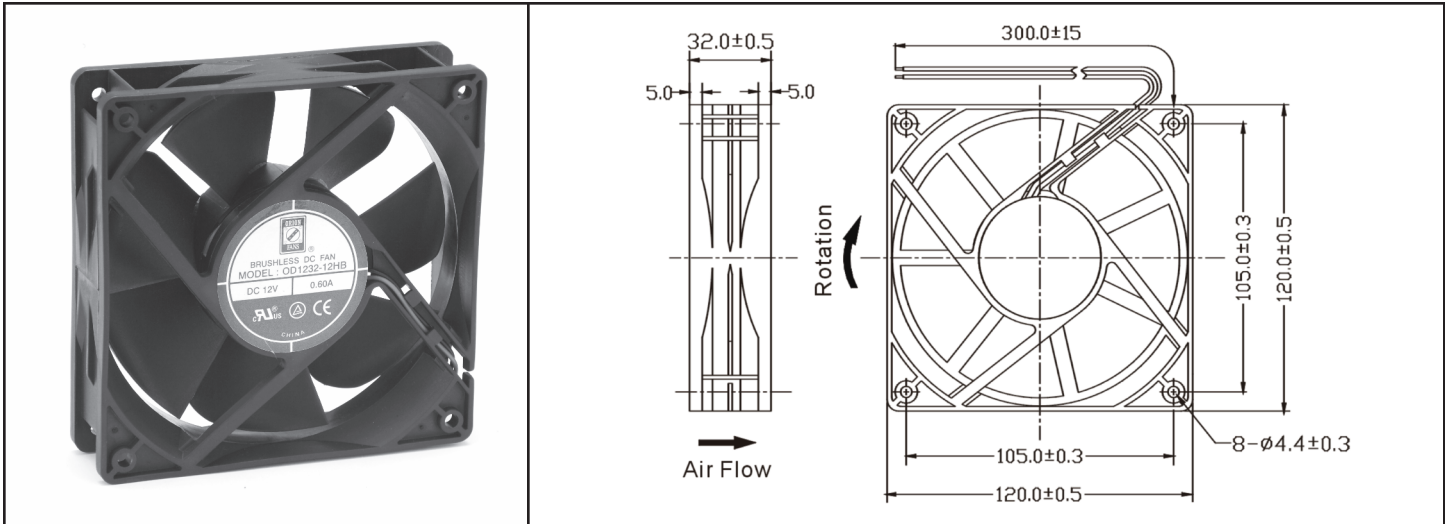

<b>Frame &amp; Impeller</b>	PBT, UL94V-0 plastic	<b>Available Options:</b> Tachometer (FG) Alarm (RD) Thermal Speed Control PWM Input <u>Life Expectancy (L10)</u> Ball Bearing 60,000 hours (L10 at 40C) Sleeve Bearing 30,000 hours (L10 at 40C) <u>Operating Temperature</u> Ball Bearing -20C ~ +75C Sleeve Bearing -10C ~ +50C  Weight: ~0.47 lbs m4	
<b>Connection</b>	2x Lead wires		
<b>Motor</b>	Brushless DC, auto restart, polarity protected		
<b>Bearing System</b>	Dual Ball or Sleeve		
<b>Insulation Resistance</b>	10M ohm between leadwire and frame (500VDC)		
<b>Dielectric Strength</b>	1 minute at 500 VAC, max leakage < 500 MicroAmp		
<b>Storage Temperature</b>	-40C ~ +80C		

Model Number	Speed (RPM)	Airflow (CFM)	Noise (dB)	Volts DC	Voltage Range	Amps	Max. Static Pressure (\"H <sub>2</sub> O)
OD1232-12H *	3750	120	51	12	6~13.8	0.60	0.42
OD1232-12M *	3300	107	48	12	6~13.8	0.50	0.33
OD1232-12L *	2900	93	44	12	6~13.8	0.32	0.27
OD1232-24H *	3750	120	51	24	12~27.8	0.28	0.42
OD1232-24M *	3300	107	48	24	12~27.8	0.22	0.33
OD1232-24L *	2900	93	44	24	12~27.8	0.22	0.27
OD1232-48H *	3750	120	51	48	24~55.2	0.16	0.42
OD1232-48M *	3300	107	48	48	24~55.2	0.15	0.33
OD1232-48L *	2900	93	44	48	24~55.2	0.13	0.27

\* Indicate "B" to specify Ball bearing or "S" to specify Sleeve bearing

# OD1232-24MB02A



DC Fan, 24VDC  
120x32mm (4.7.62x1.25in)



Frame & Impeller	PBT, UL94V-0 plastic	<b>Available Options</b> IP55 Other speeds and voltages Tachometer PWM  *Connection: Wire Leads - UL1007 24AWG Red(+), Black(-), Yellow Alarm  Weight: 250 g	
Connection	3x Lead wires *		
Motor	Brushless DC, auto restart, polarity protected.		
Bearing System	Dual ball bearing		
Insulation Resistance	Min. 10M at 500VDC		
Dielectric Strength	1 second at 500VAC max leakage 500 microamp		
Temperature Range	-10C ~ +70C		
Storage Temperature	-40C ~ +80C		
Life (L10)	70,000 hours (40C)		

Model Number	OD1232-24MB02A	
Part Number	124231231	
Nominal Voltage	24 VDC	
Voltage Range	12~27.6 VDC	
Nominal Current	.22 A	
Rated Power	5.28Watts	
Rated Speed (RPM)	3300	
Airflow (CFM)	107	
Noise Level (dB)	48	
Max. Static Pressure	.33 "H <sub>2</sub> O	

# OD1232-48MB02A



DC Fan, 48VDC  
120x32mm (4.7.62x1.25in)

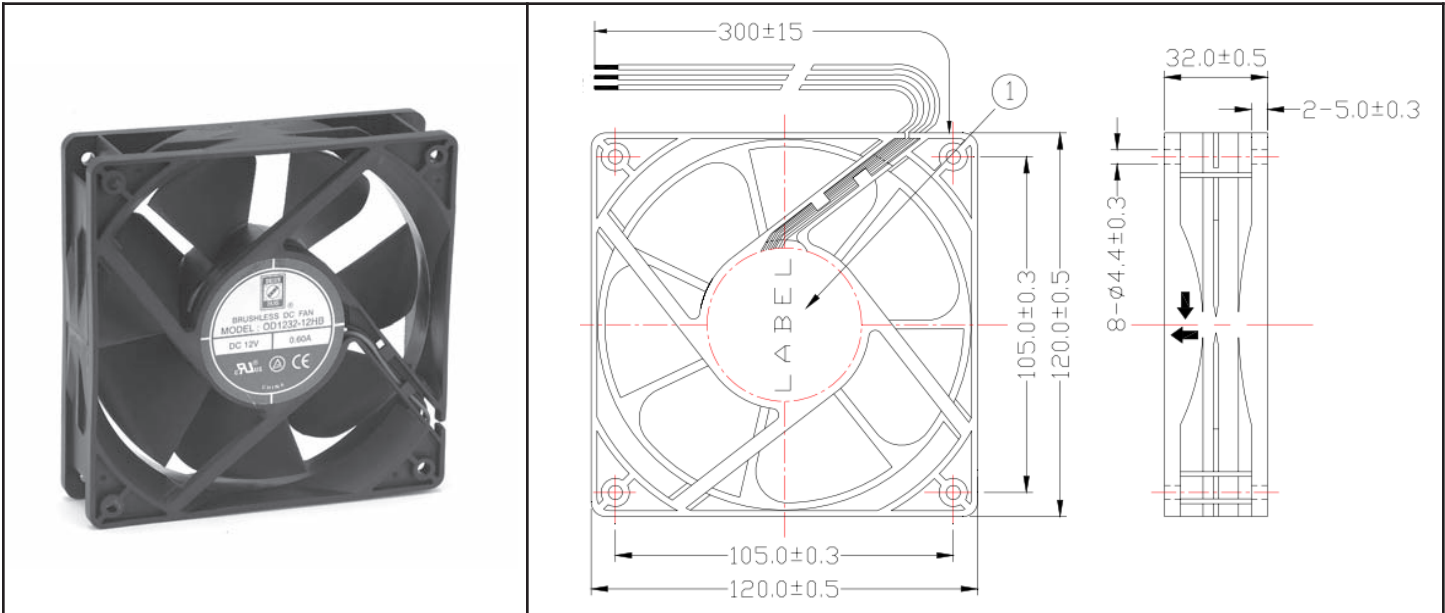

Frame & Impeller	PBT, UL94V-0 plastic	<b>Available Options</b> IP55 Other speeds and voltages Tachometer PWM  *Connection: Wire Leads - UL1007 24AWG Red(+), Black(-), Yellow Alarm  Weight: 250 g	
Connection	3x Lead wires *		
Motor	Brushless DC, auto restart, polarity protected.		
Bearing System	Dual ball bearing		
Insulation Resistance	Min. 10M at 500VDC		
Dielectric Strength	1 second at 500VAC max leakage 500 microamp		
Temperature Range	-10C ~ +70C		
Storage Temperature	-40C ~ +80C		
Life (L10)	70,000 hours (40C)		

Model Number	OD1232-48MB02A	 
Part Number	124431231	
Nominal Voltage	48 VDC	
Voltage Range	24~55.2 VDC	
Nominal Current	.15 A	
Rated Power	7.2 Watts	
Rated Speed (RPM)	3300	
Airflow (CFM)	107	
Noise Level (dB)	48	
Max. Static Pressure	.33 "H <sub>2</sub> O	