

REVISIONS				
P.	LTN.	DESCRIPTION	DATE	APVD.
C2		REVISED PER ECO-15-004915	10APR2015	AP DD

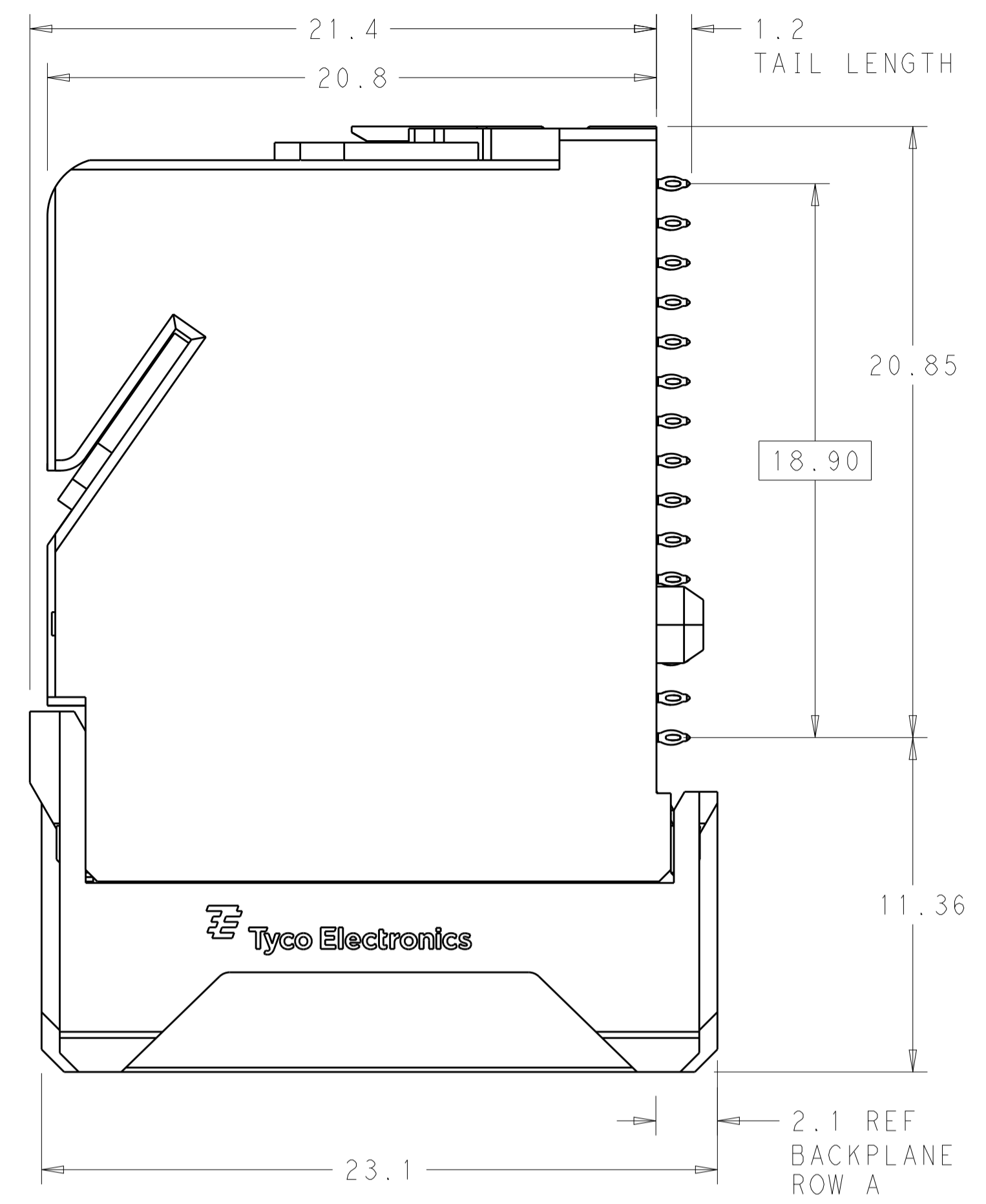

⚠ MATERIAL:  
HOUSING: LCP, GLASS FILLED, UL94V-0.  
TERMINALS: HIGH PERFORMANCE COPPER ALLOY.

⚠ FINISH:  
30µ" SELECTIVE GOLD IN CONTACT AREA. SELECTIVE TIN ON PCB TAILS, NICKEL OVERALL.

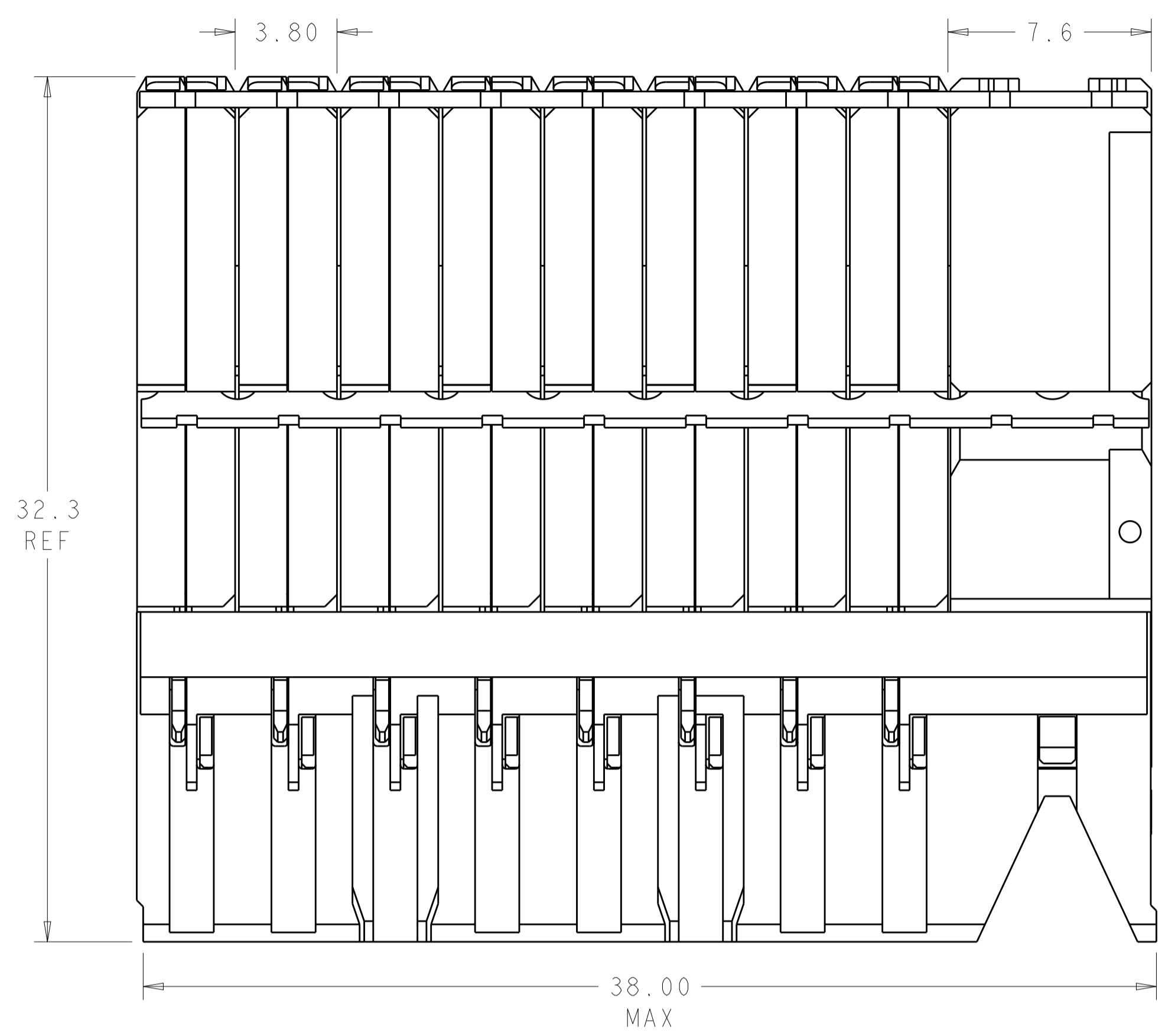
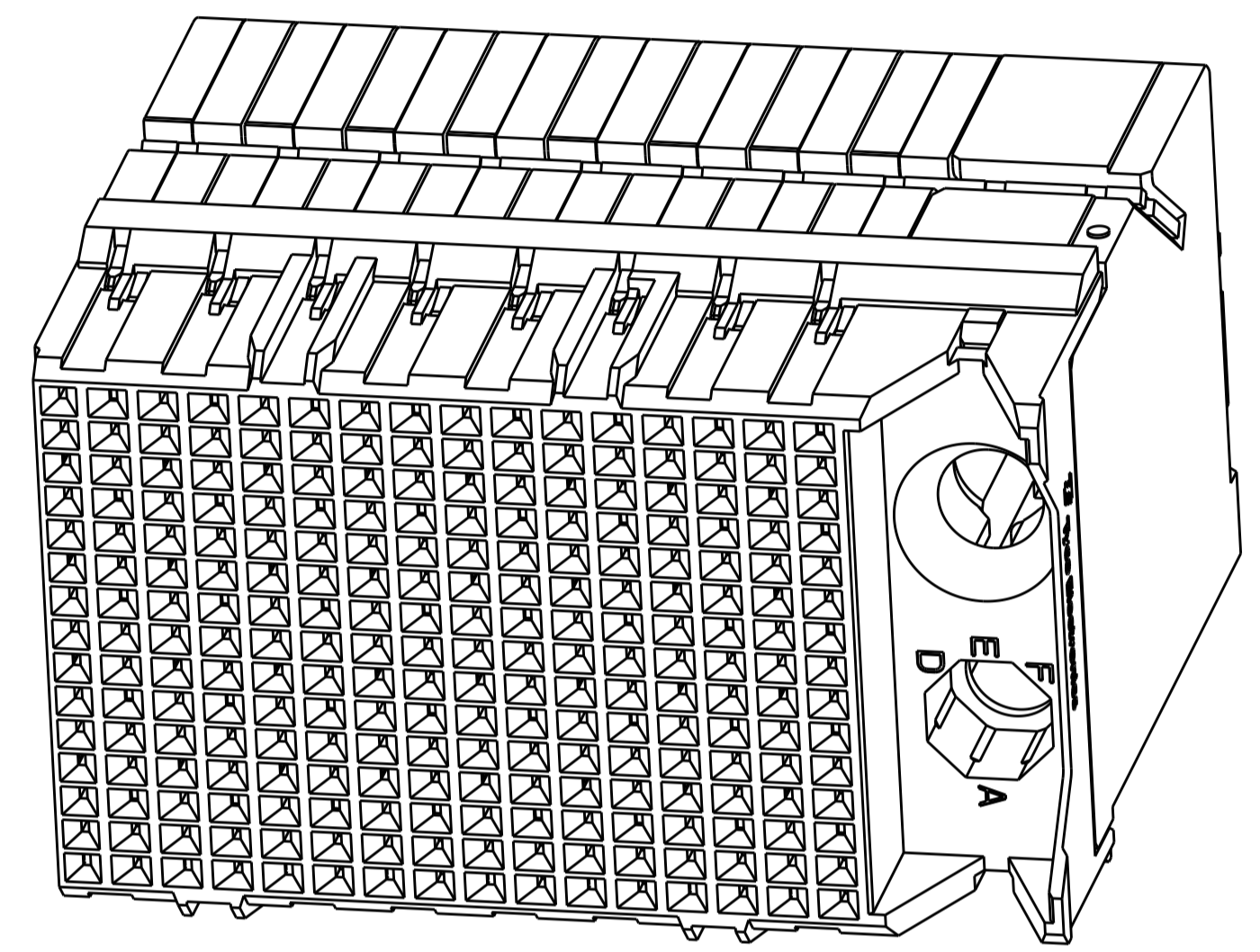

SCALE 4:1

REFER TO WWW.TE.COM FOR PRODUCT AVAILABILITY

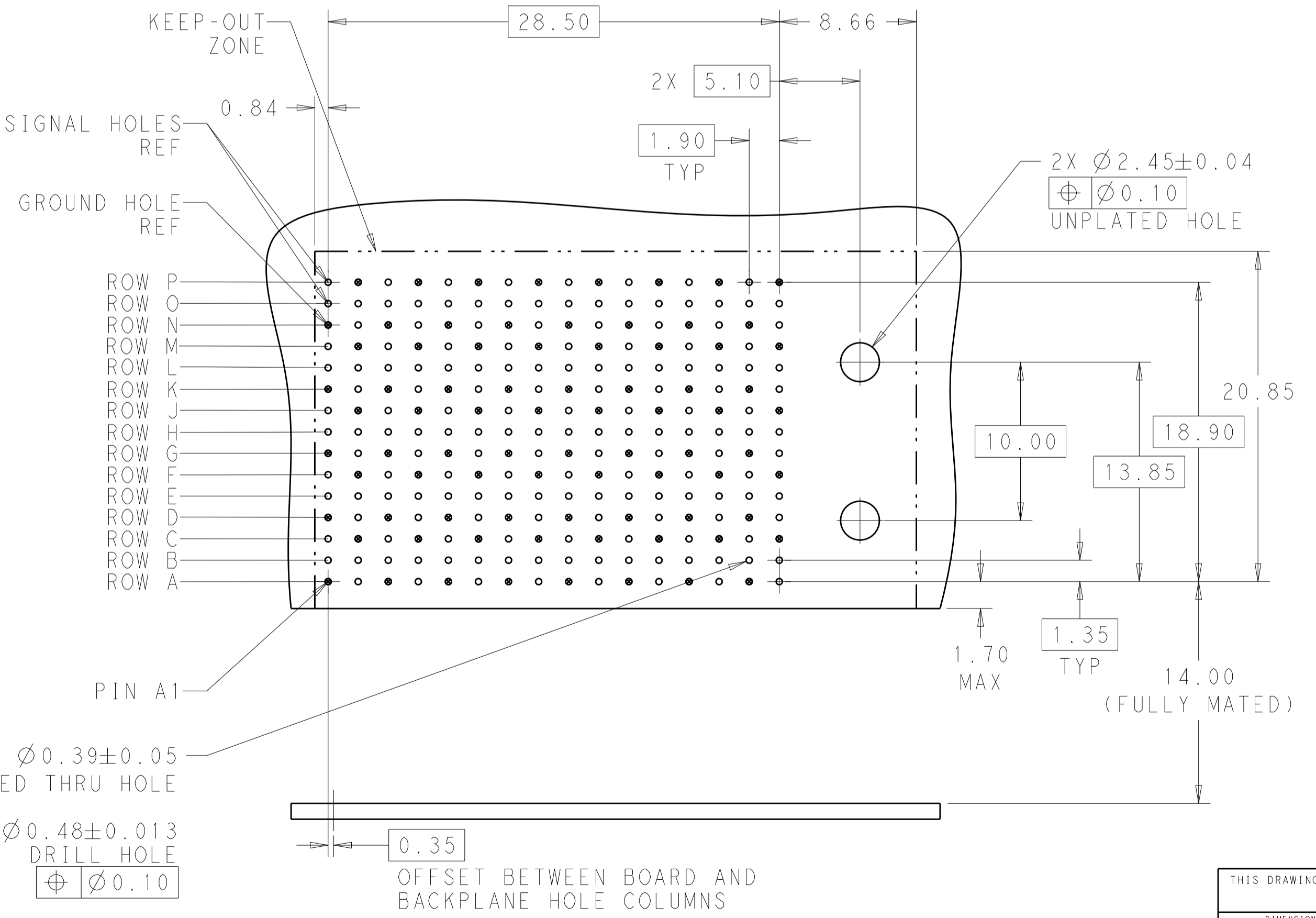
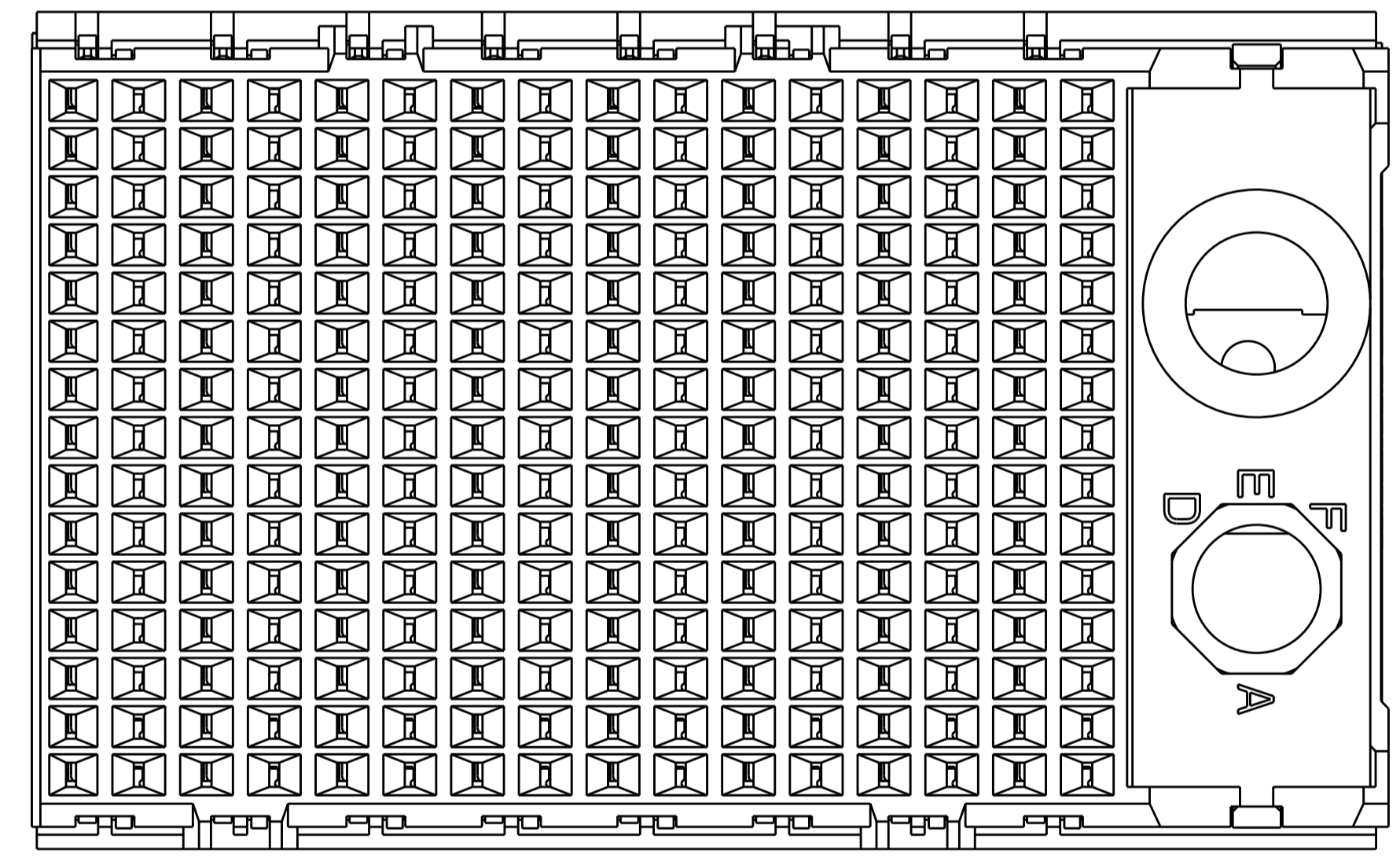

KEY POSITION CHART	
	NONE
	A
	B
	C
	D
	E
	F
	G
	H

240X Ø0.39±0.05 PLATED THRU HOLE

240X Ø0.48±0.013 DRILL HOLE  
⊕ Ø0.10

RECOMMENDED PCB LAYOUT  
MIN BOARD THICKNESS 1.0

KEY POSITION	FINISH	PART NUMBER
H	⚠	8-2110123-1
G	⚠	7-2110123-1
F	⚠	6-2110123-1
E	⚠	5-2110123-1
D	⚠	4-2110123-1
C	⚠	3-2110123-1
B	⚠	2-2110123-1
A	⚠	1-2110123-1
NONE	⚠	2110123-1

THIS DRAWING IS A CONTROLLED DOCUMENT.

OWN: B. CARBO 06JAN2011  
CHK: D. DIXON 06JAN2011  
APVD: D. DIXON 06JAN2011

DIMENSIONS: mm

TOLERANCES UNLESS OTHERWISE SPECIFIED:  
0 PLC ±  
1 PLC ±0.2  
2 PLC ±0.13  
3 PLC ±  
4 PLC ±  
ANGLES ±

MATERIAL: SEE TABLE

FINISH: SEE TABLE

NAME: IMPACT, 5 PAIR, DAUGHTERCARD 16 COLUMN, RIGHT GUIDED, SIGNAL MODULE, 0.39 EYELET

SIZE: A1  
CAGE CODE: 00779  
DRAWING NO: C=2110123

RESTRICTED TO: Customer Drawing

SCALE: 6:1 SHEET 1 OF 1 REV: C2