

THIS DRAWING IS UNPUBLISHED.
 DIFFUSION RESTREINTE
 © COPYRIGHT 20

RELEASED FOR PUBLICATION
 LIBRE A LA DIFFUSION
 ALL RIGHTS RESERVED.
 TOUS DROITS RESERVES

REVISIONS					
P	LTR	DESCRIPTION MODIFICATIONS	DATE	DWN DESS.	APVD APP.
A		VUE AVEC LOGO TE	04MAY2009	P.B	-
B		0.9+0.15-0.05 ETAIT 0.9+-0.05	06JUL2011	PB	JP P

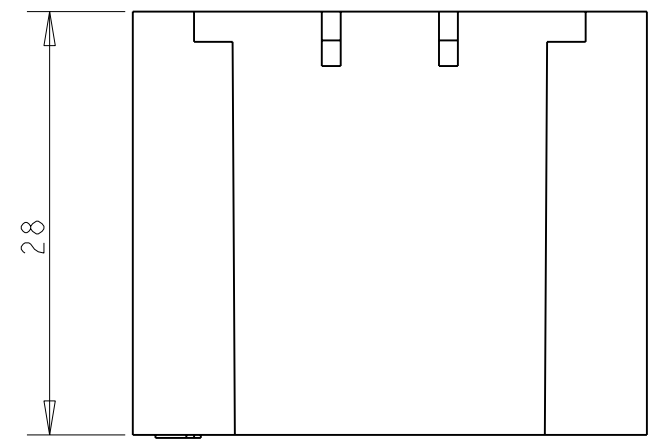
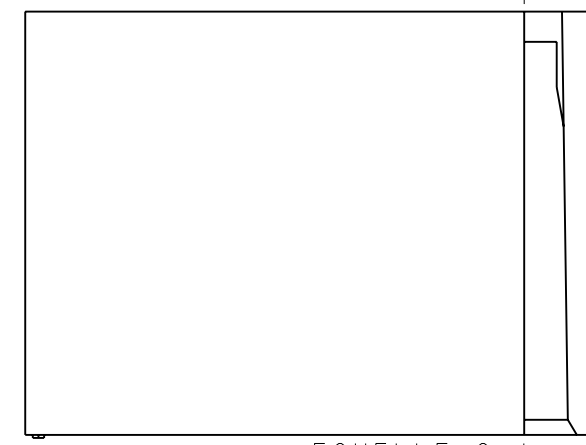
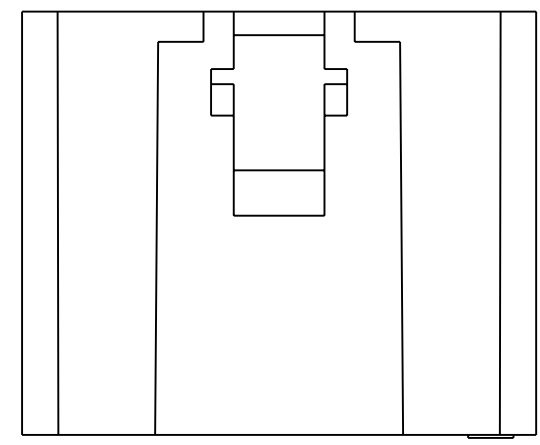
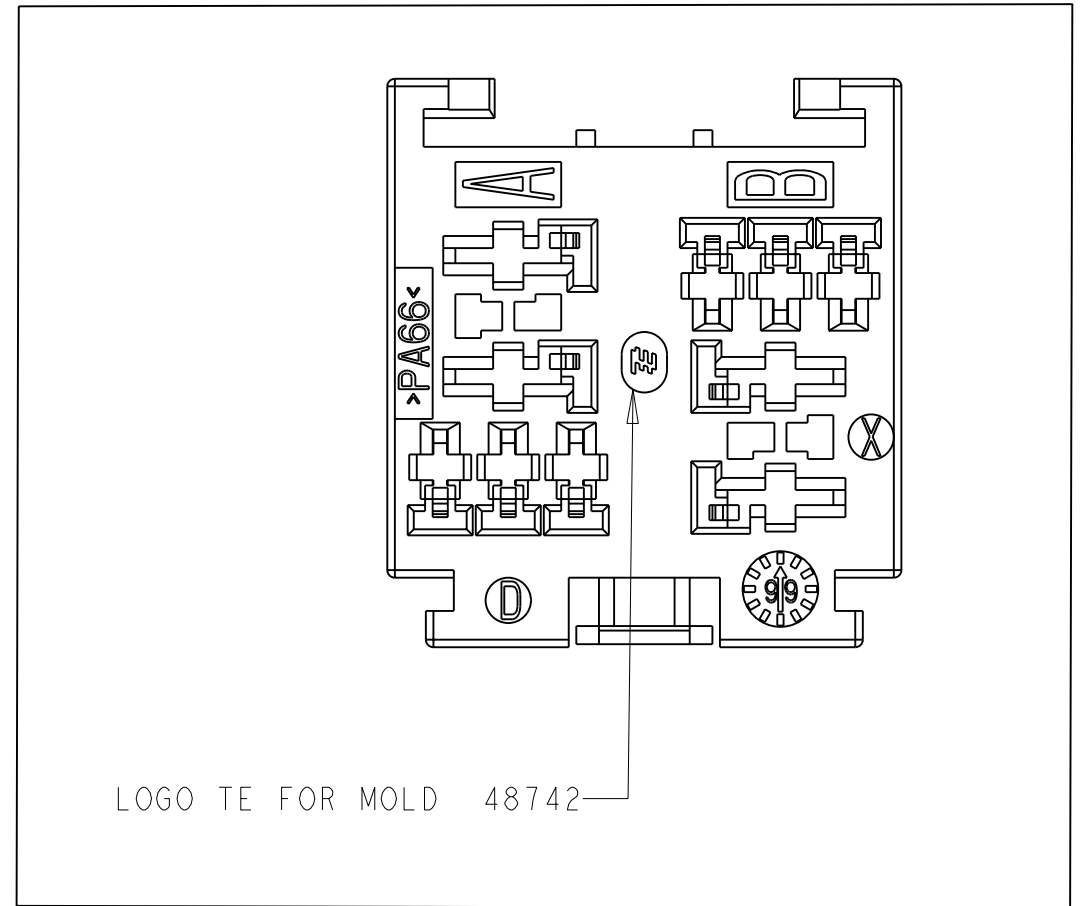
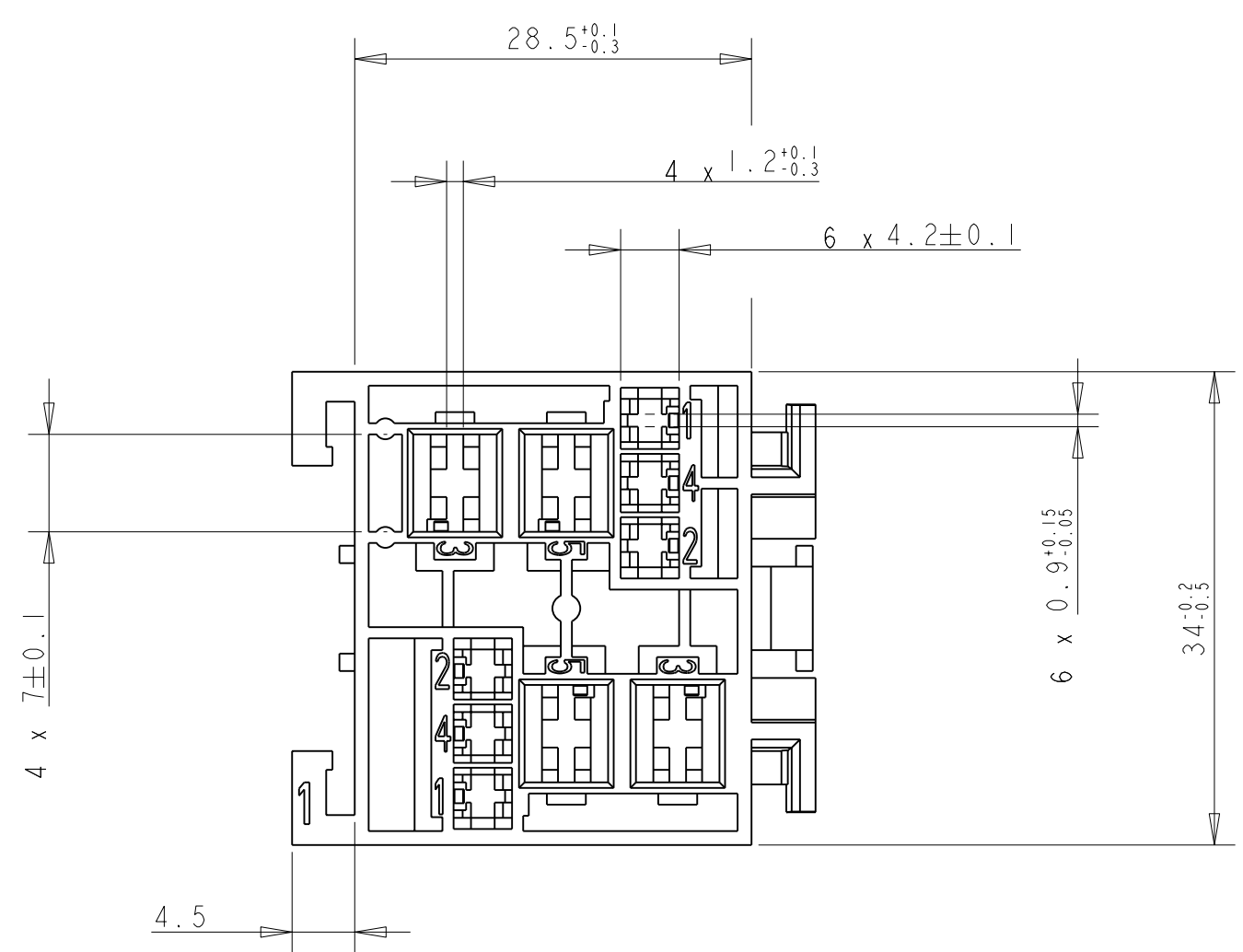

**COMPOSANTS ASSOCIES
(APPLIED COMPONENTS)**

DESIGNATION (DESCRIPTION)	Ref TE (TE PN)
JPT 0.35-1mm ²	144431-1
JPT 1-3mm ²	144432-1
SPT 0.5-1mm ²	927831-2
SPT 1-3mm ²	144617-1
SPT 3-5mm ²	144433-1
SPT 5-7mm ²	144434-1

GRIS (GREY)	PA 6.6	185402-3
NOIR (BLACK)	PA 6.6	185402-2
CRISTAL (NATUREL) (CRYSTAL (NATURAL))	PA 6.6	185402-1
COULEUR (COLOR)	MATIERE (MATERIAL)	REF TE (TE PN)

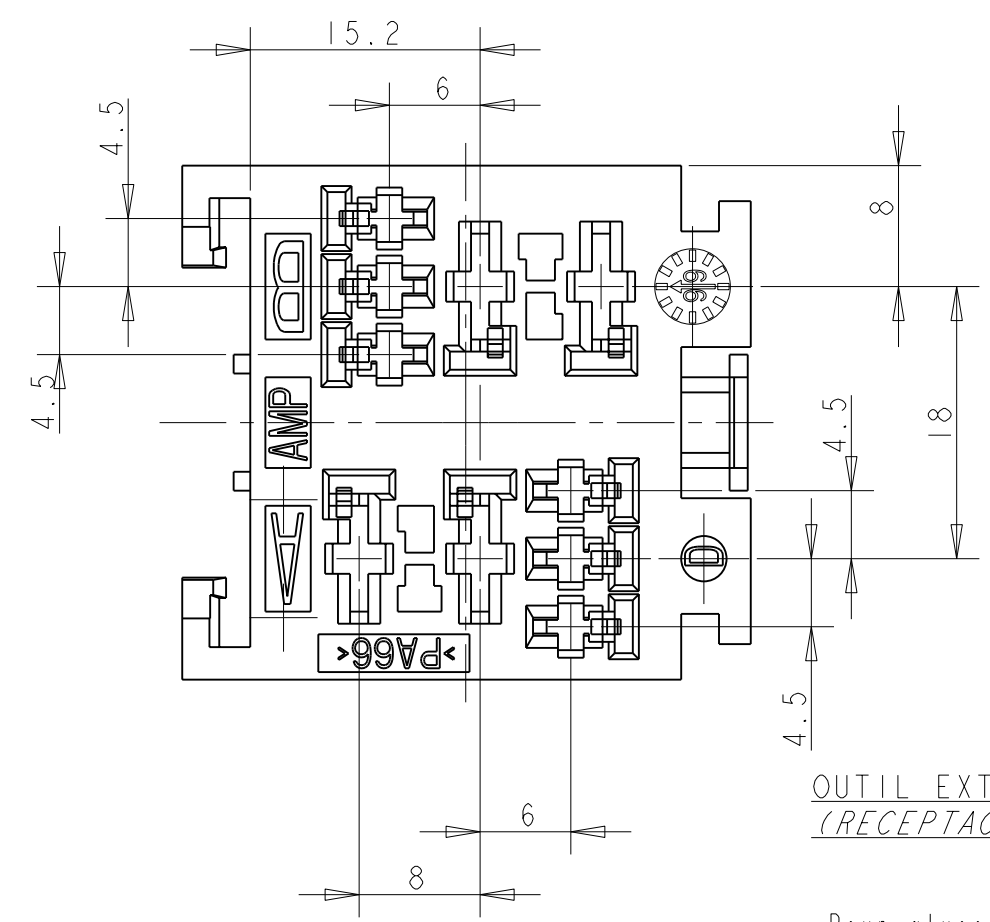

**OUTIL EXTRACTEUR DE CLIPS:
(RECEPTACLE EXTRACTION TOOL)**

- Pour alveole Relais 2.8 Ref:951746-1
(FOR RELAY CAVITY)
- Pour alveole Relais 6.35 Ref:951745-1
(FOR RELAY CAVITY)

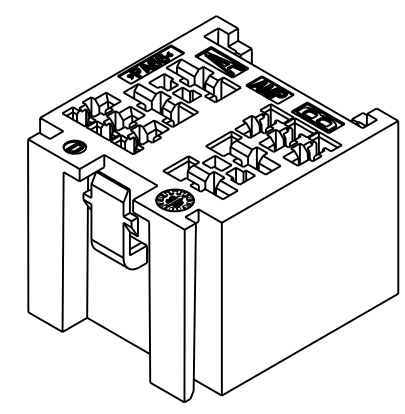

REFERENCE REPRESENTEE: 185402-1

THIS DRAWING IS A CONTROLLED DOCUMENT. <small>CE PLAN EST UN DOCUMENT CONTROLE PAR TYCO ELECTRONICS. IL EST SUSCEPTIBLE D'ETRE REVISE. CONTACTER LE SERVICE TECHNIQUE DE TYCO ELECTRONICS POUR OBTENIR LA DERNIERE REVISION.</small>		DWN /DESSINE R. PATIN 31MAR2004	TE Connectivity	
DIMENSIONS: mm		CHK /VERIFIE JP. PICAUD 31MAR2004		
TOLERANCES UNLESS OTHERWISE SPECIFIED: TOLERANCES NON SPECIFIEES (SUIV NB DE DECIMALES) 0 PLC/DEC: ± 1 PLC/DEC: ±0.2 2 PLC/DEC: ± 3 PLC/DEC: ± 4 PLC/DEC: ± ANGLES ±5°		APVD /APROUVE J. DAHER 31MAR2004	NAME /TITRE MODULE UNITAIRE 2 MICRO-RELAIS	
MATERIAL /MATIERE VOIR TABLE		PRODUCT SPEC SPEC. PRODUIT 108-15131	SIZE /FORMAT A2	
FINISH /FINITION VOIR TABLE		APPLICATION SPEC SPEC. APPLICATION 411-15551	CAGE CODE 00779	
		WEIGHT /MASSE APPROX. 16g	DRAWING NO /No PLAN 185402	
		CUSTOMER DRAWING /PLAN CLIENT	RESTRICTED TO RESERVE A -	
		UNIQUEMENT POUR REFERENCE	SHEET /FEUILLE 1	
		SCALE /ECHELLE 2:1	OF /DE 1	
			REV B	