

IEC Appliance Inlet C14 with Filter 2-Stages, Fuseholder 1- or 2-pole, Line Switch 2-pole



Screw-on mounting horizontal (version B)
 Order required accessories separately

Screw-on mounting vertical (version A)

Snap-in mounting



See below:
[Approvals and Compliances](#)

Description

- Panel mount :
 Snap-in or screw-on mounting from front side
- 4 Functions :
 Appliance Inlet Protection class I , Line Switch 2-pole , Fuseholder for fuse-links 5 x 20 mm 1- or 2-pole , 2-Stages line filter in standard and medical version
- V-Lock notch standard
- Quick connect terminals 6.3 x 0.8 mm

Unique Selling Proposition

- Most compact power entry module with 2-stages filter
- Attractive flat design
- Various mounting options
- V-Lock cord retaining

Characteristics

- Ultra-compact design. Ideal for low profile designs
 Aluminum case provides good shielding
- All single elements are already wired
- Fuse drawer meets requirements of medical standard IEC/EN 60601-1
- Ideal for application with high transient loads
- Suitable for use in medical equipment according to IEC/UL 60601-1
 For applications according IEC/UL 62368-1 we recommend variants with bleed resistor

Other versions on request

- Solder terminals
- Fuse drawer 1-pole, plus spare fuse case
- Fuse drawer 2-pole, with shorting bar
- Other rocker marking
- Line switch, illuminated
- Line switch 1-pole
- Medical Version (M80)
- Class X1- and Y1-capacitors for enhanced withstand voltage

References

Alternative: version without line filter [DD11](#)
 Alternative: version with 1-stage filter [DD12](#)

Weblinks

[pdf data sheet](#), [html datasheet](#), [General Product Information](#), [Approvals](#), [Distributor-Stock-Check](#), [Accessories](#), [Detailed request for product](#), [Landing Page](#)

Technical Data

Ratings IEC	1 - 10A @ Ta 40 °C / 250VAC; 50Hz	Appliance inlet/-outlet	C14 acc. to IEC 60320-1
Ratings UL/CSA	1 - 8A @ Ta 40 °C / 250VAC; 60Hz		UL 498, CSA C22.2 no. 42 (for cold conditions) pin-temperature 70 °C, 10A, Protection Class I
Leakage Current	standard < 0.5mA (250V / 60Hz) medical < 5 µA (250 V / 60 Hz)	Fuseholder	1 or 2 pole, Shocksafe category PC2 acc. to IEC 60127-6, for fuse-links 5 x 20mm
Dielectric Strength	> 1.7kVDC between L-N > 2.7kVDC between L/N-PE Test voltage (2 sec)	Rated Power Acceptance @ Ta 23 °C	5 x 20: 2W (1 pole)/ 1.6W (2-pole) per pole
Allowable Operation Temperature	-25 °C to 85 °C	Power Acceptance @ Ta > 23°C	Admissible power acceptance at higher ambient temperature see derating curves
Climatic Category	25/085/21 acc. to IEC 60068-1	Line Switch	Rocker switch 2-pole, non-illuminated, acc. to IEC 61058-1 Technical Details
IP-Protection	from front side IP40 acc. to IEC 60529	Line Filter	Standard and Medical Version, IEC 60939, UL 1283, CSA C22.2 no. 8 Technical Details
Protection Class	Suitable for appliances with protection class I acc. to IEC 61140	MTBF	> 2'000'000h acc. to MIL-HB-217 F
Terminal	Quick connect terminals 6.3 x 0.8 mm		
Panel Thickness S	Screw-on mounting: max 8mm Mounting screw torque max 0.5Nm Snap-in version: 1 mm - 3mm		
Material: Housing	Thermoplastic, black, UL 94V-0		

Approvals and Compliances



Detailed information on product approvals, code requirements, usage instructions and detailed test conditions can be looked up in [Details about Approvals](#)

SCHURTER products are designed for use in industrial environments. They have approvals from independent testing bodies according to national and international standards. Products with specific characteristics and requirements such as required in the automotive sector according to IATF 16949, medical technology according to ISO 13485 or in the aerospace industry can be offered exclusively with customer-specific, individual agreements by SCHURTER.

Approvals









The approval mark is used by the testing authorities to certify compliance with the safety requirements placed on electronic products.

Approval Reference Type: DD14

Approval Logo	Certificates	Certification Body	Description
	VDE Approvals	VDE	Certificate Number: 40001522
	UL Approvals	UL	UL File Number: E72928



Product standards

Product standards that are referenced

Organization	Design	Standard	Description
	Designed according to	IEC 60320-1	Appliance couplers for household and similar general purposes
	Designed according to	IEC 60939	Passive filters for suppressing electromagnetic interference
	Designed according to	IEC 60127-6	Miniature fuses. Part 6. Fuse-holders for miniature fuse-links
	Designed according to	IEC 61058-1	Switches for appliances. Part 1. General requirements
	Designed according to	UL 498	Standard for Attachment Plugs and Receptacles
	Designed according to	UL 1283	Electromagnetic interference filters
	Designed according to	CSA C22.2 no. 42	General Use Receptacles, Attachment Plugs, and Similar Wiring Devices
	Designed according to	CSA C22.2 no. 8	Electromagnetic interference (EMI) filters







Application standards

Application standards where the product can be used

Organization	Design	Standard	Description
	Designed for applications acc.	IEC/UL 62368-1	IEC 62368-1 includes the basic requirements for safety of audio, video, information technology and office equipment.
	Designed for applications acc.	IEC 60601-1	Medical electrical equipment - Part 1: General requirements for basic safety and essential performance
	Designed for applications acc.	IEC 60335-1	Safety of electrical appliances for household and similar purposes. Meets the requirements for appliances in unattended use. This includes the enhanced requirements of glow wire tests acc. to IEC 60695-2-11 or -12 & -13.

Compliances

The product complies with following Guide Lines

Identification	Details	Initiator	Description
	RoHS	SCHURTER AG	Directive RoHS 2011/65/EU, Amendment (EU) 2015/863
	China RoHS	SCHURTER AG	The law SJ / T 11363-2006 (China RoHS) has been in force since 1 March 2007. It is similar to the EU directive RoHS.
	REACH	SCHURTER AG	On 1 June 2007, Regulation (EC) No 1907/2006 on the Registration, Evaluation, Authorization and Restriction of Chemicals 1 (abbreviated as "REACH") entered into force.
	Landing Page V-Lock	SCHURTER AG	V-Lock system are based on a matching plug-dose combination. The connector is equipped with a notch intended for use with the latching cordset. The cord latching system prevents against accidental removal of the cordset.
	White Paper Glow wire test	SCHURTER AG	Meets the requirements of IEC 60335-1 for appliances in unattended use. This includes the enhanced requirements of glow wire tests acc. to IEC 60695-2-11 or -12 & -13.
	Medical Technology	SCHURTER AG	Suitable for use in medical equipment according to IEC/UL 60601-1

Dimension [mm]

Screw version A

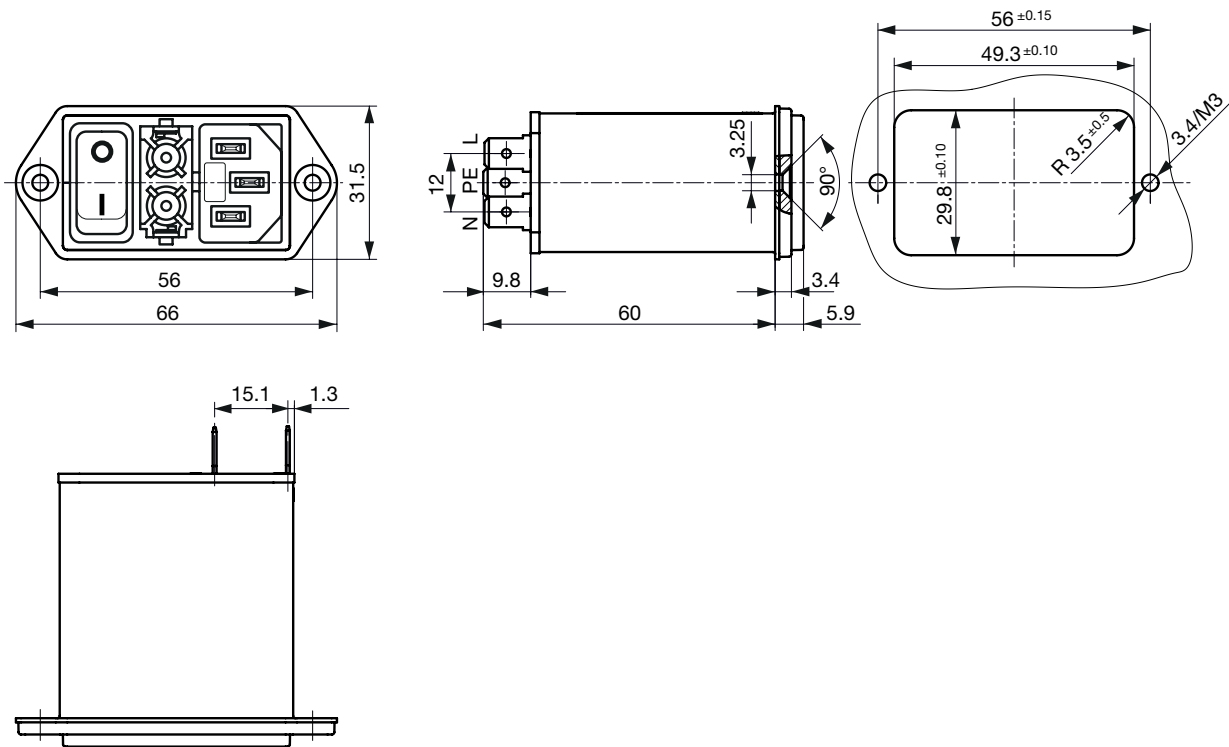

Screw version B

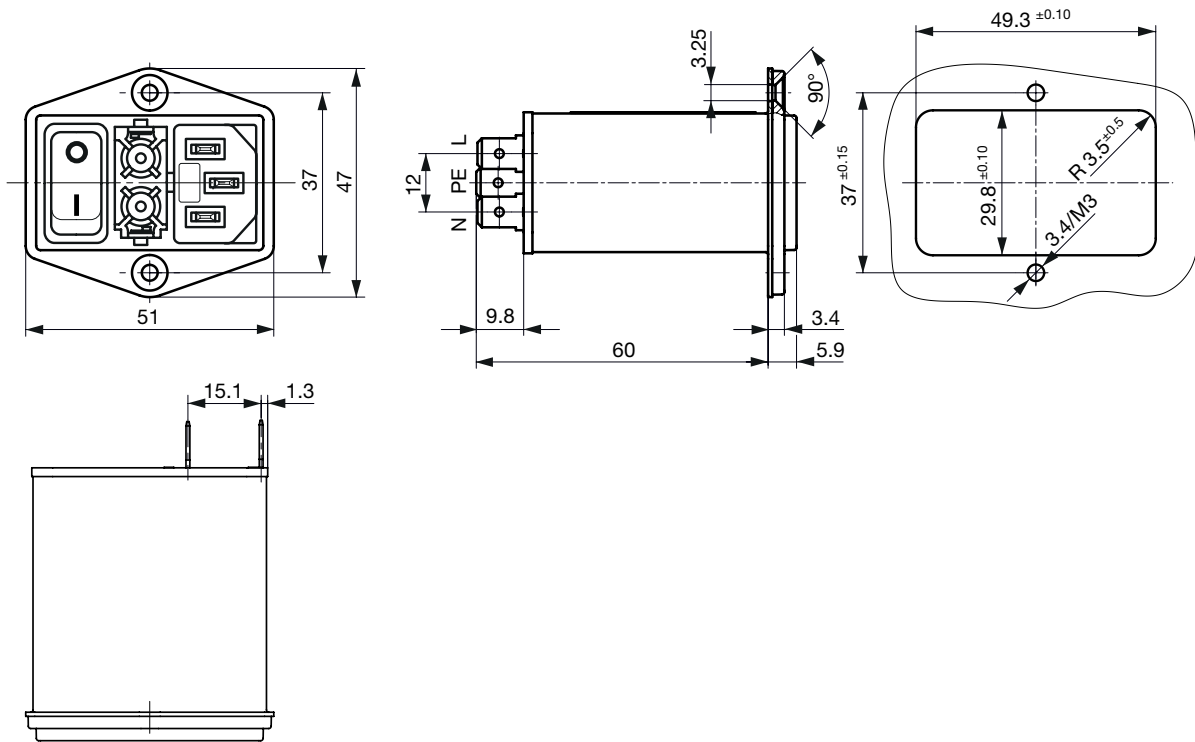

Snap-in mounting from front side

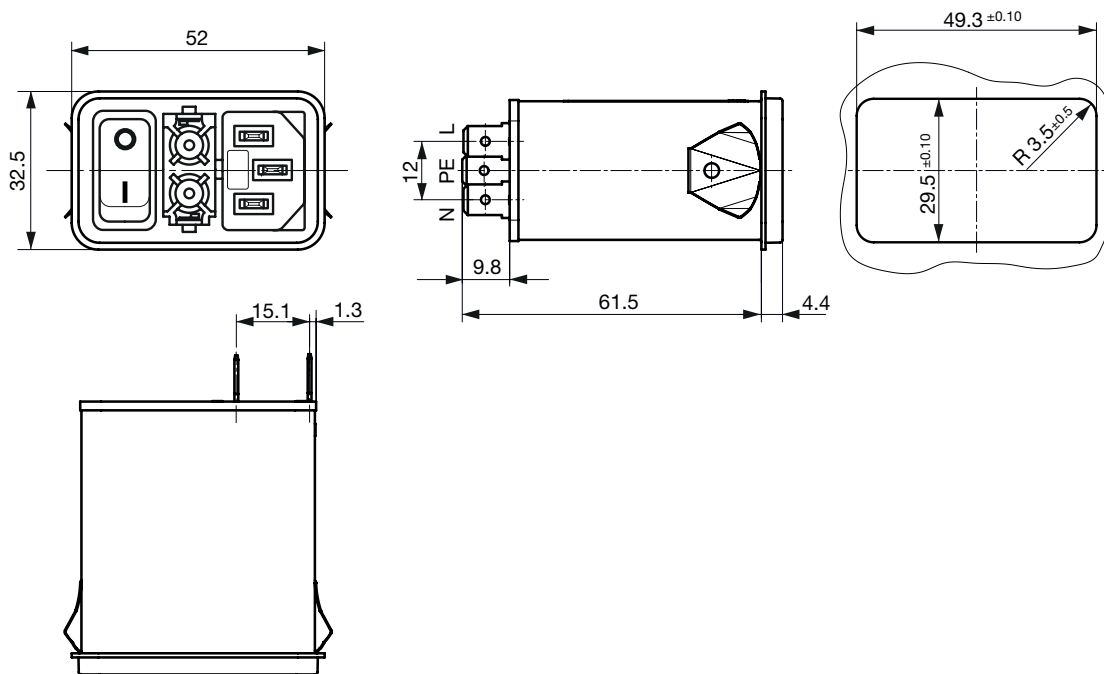

Technical Data of Filter-Components

Rated Current [A]	Filter-Type	Inductances L [mH]	Capacitance CX [nF]	Capacity Cy1 [nF]	Capacity Cy2 [nF]	R [MΩ]
1	Standard version	2 x 10	220	1.5	1	1
2	Standard version	2 x 4	220	1.5	1	1
4	Standard version	2 x 1.5	220	1.5	1	1
6	Standard version	2 x 0.8	220	1.5	1	1
8	Standard version	2 x 0.6	220	1.5	1	1
10	Standard version	2 x 0.3	220	1.5	1	1
1	Medical Version (M5)	2 x 10	220	-	-	1
2	Medical Version (M5)	2 x 4	220	-	-	1
4	Medical Version (M5)	2 x 1.5	220	-	-	1
6	Medical Version (M5)	2 x 0.8	220	-	-	1
8	Medical Version (M5)	2 x 0.6	220	-	-	1
10	Medical Version (M5)	2 x 0.3	220	-	-	1

Diagrams

Standard version

Standard version

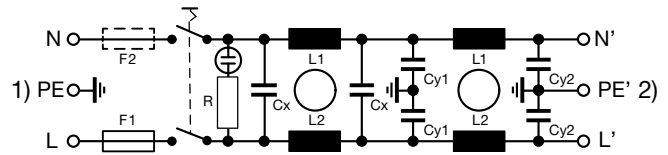
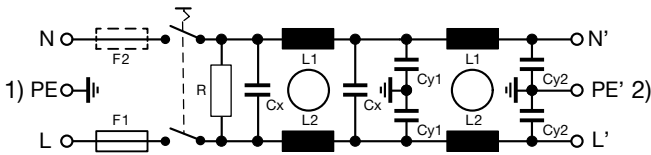

1) Line
2) Load

1) Line
2) Load

Medical Version (M5)

Medical Version (M5)

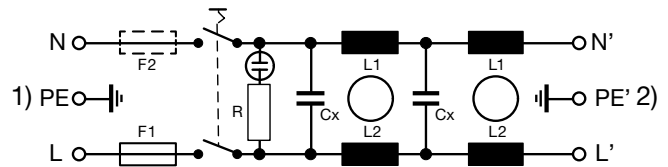
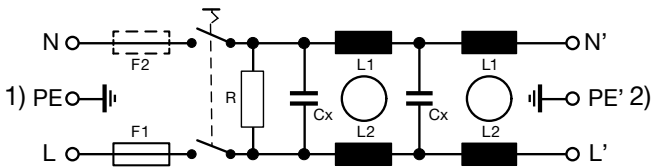

1) Line
2) Load

1) Line
2) Load

Derating Curves

1-pole

2-pole

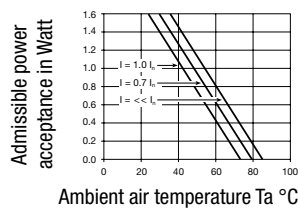
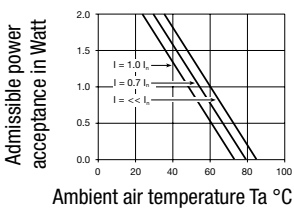

Attenuation Loss

--- 50Ω differential mode ___ 50Ω common mode

Standard version

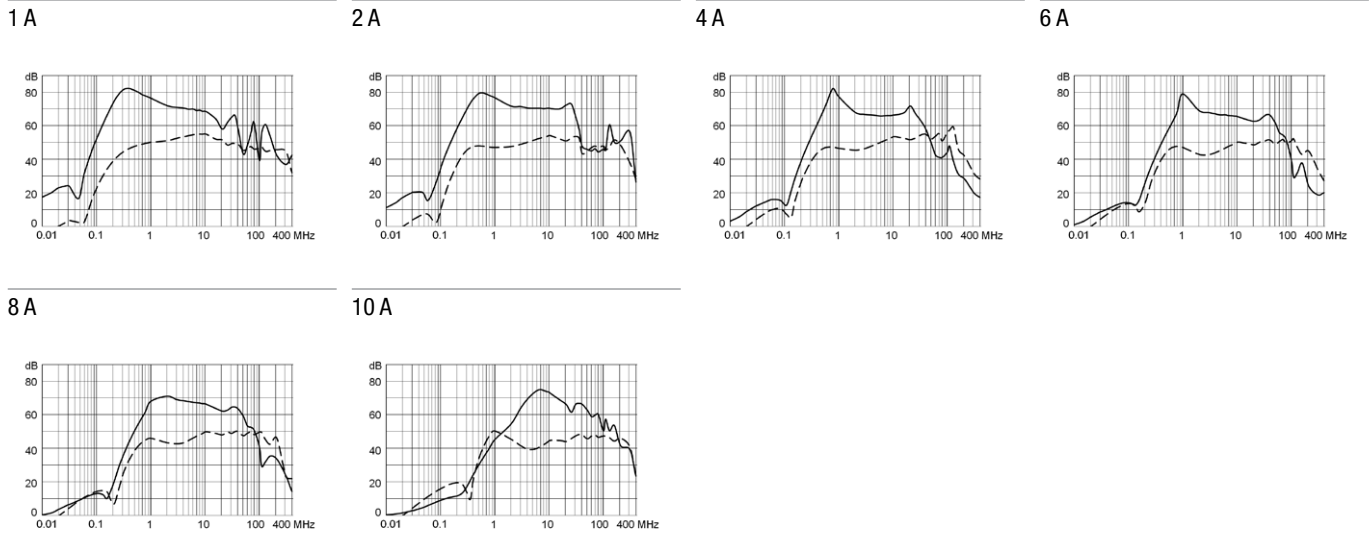

Medical version (M5)

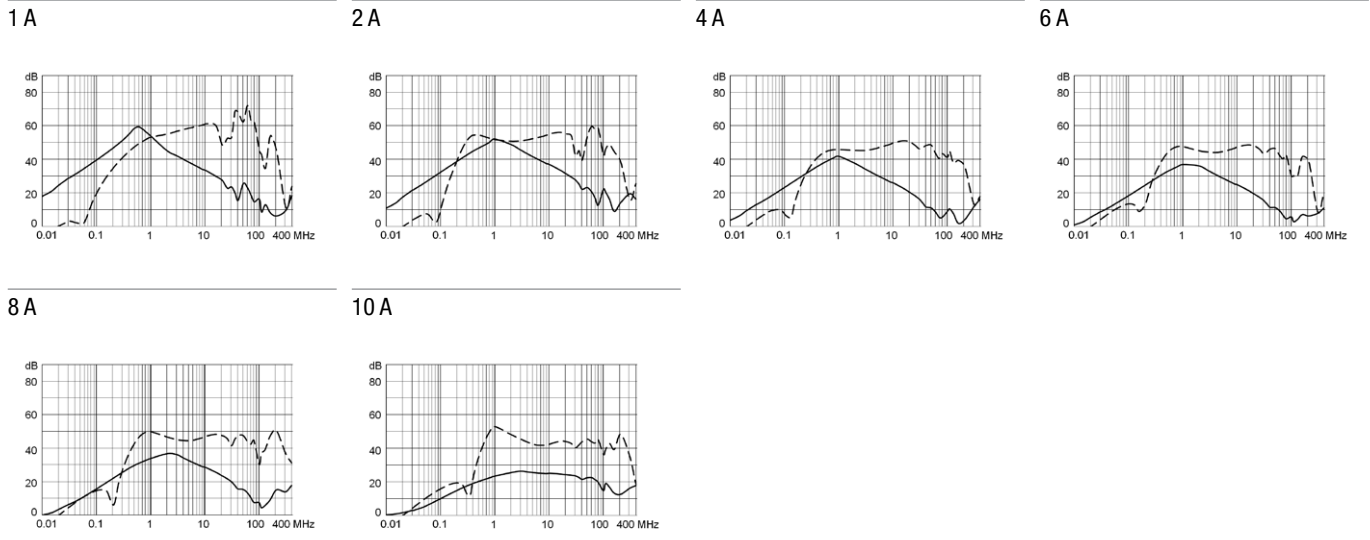

All Variants

Rated Current [A]	Filter-Type	Mounting	Fuseholder	Line Switch	Illumination	Color	Order Number
1	Standard version	Screw-on A	2-pole	2-pole	non-illuminated	black	3-103-776
2	Standard version	Screw-on A	2-pole	2-pole	non-illuminated	black	3-103-777
4	Standard version	Screw-on A	2-pole	2-pole	non-illuminated	black	3-103-778
6	Standard version	Screw-on A	2-pole	2-pole	non-illuminated	black	3-102-850
6	Standard version	Screw-on B	2-pole	2-pole	non-illuminated	black	3-102-852
6	Standard version	Snap-in	2-pole	2-pole	non-illuminated	black	3-102-854
8	Standard version	Screw-on A	2-pole	2-pole	non-illuminated	black	3-103-779
10	Standard version	Screw-on A	2-pole	2-pole	non-illuminated	black	3-103-780
10	Standard version	Snap-in	2-pole	2-pole	non-illuminated	black	3-103-789
10	Standard version	Screw-on B	2-pole	2-pole	non-illuminated	black	3-105-326
1	Medical Version (M5)	Screw-on A	2-pole	2-pole	non-illuminated	black	3-104-202
2	Medical Version (M5)	Screw-on A	2-pole	2-pole	non-illuminated	black	3-104-203
4	Medical Version (M5)	Screw-on A	2-pole	2-pole	non-illuminated	black	3-104-204
6	Medical Version (M5)	Screw-on A	2-pole	2-pole	non-illuminated	black	3-104-205

Rated Current [A]	Filter-Type	Mounting	Fuseholder	Line Switch	Illumination	Color	Order Number
8	Medical Version (M5)	Screw-on A	2-pole	2-pole	non-illuminated	black	3-104-206
10	Medical Version (M5)	Screw-on A	2-pole	2-pole	non-illuminated	black	3-104-207

Most Popular.

Availability for all products can be searched real-time: <https://www.schurter.com/en/Stock-Check/Stock-Check-SCHURTER>

10 A version only IEC approval.

Packaging unit 10 Pcs

Required Accessory

Description



Fusedrawer 2
 Fusedrawer für Fuse Links 5x20 mm, with or without Voltage Selector Insert

Accessories



Wire Harness
 Wire harness for SCHURTER products



Assorted Covers
 Rear Cover



Cord retaining kits
 Cord retaining strain relief

Mating Outlets/Connectors

Category / Description

[Appliance Outlet Overview complete](#)



4787, Mounting: Screw-on mounting, Appliance Outlet: IEC Solder terminals, 10 A, Suitable for appliances with protection class I	4787
4788, Mounting: Snap-in version, Appliance Outlet: IEC Solder terminals or quick connect terminals, 10 A, Suitable for appliances with protection class I	4788
IEC Appliance Outlet F or H, Screw-on Mounting, Front Side, Solder, PCB or Quick-connect Terminal	5091

[Appliance Outlet further types to DD14](#)

[Connector Overview complete](#)



4782 Mounting: Power Cord, 3 x 1 mm ² / 3 x 18 AWG, Cable, Connector: IEC C13	4782
4785 Mounting: Power Cord, 3 x 1 mm ² / 3 x 18 AWG, Cable, Connector: IEC C13	4785
4012 Mounting: Power Supply Cord, 3 x 1 mm ² , Screw clamps, Connector: IEC C13	4012
4300-06 Mounting: Power Cord, 3 x 1 mm ² / 3 x 18 AWG, Cable, Connector: IEC C13	4300-06
4781 Mounting: Power Cord, 3 x 1 mm ² / 3 x 18 AWG, Cable, Connector: IEC C15	4781

[Connector further types to DD14](#)

...

Mating Outlets/Connectors shuttered

[Connector Overview complete](#)



4783 Mounting: Power Cord, 3 x 1 mm ² / 3 x 18 AWG, Cable, Connector: IEC C13	4783
--	------

[Connector further types to DD14](#)

[Power Cord Overview complete](#)



VAC13KS, Overview, V-Lock cord retaining, diverse Connector IEC C13, diverse, black	VAC13KS
---	---------

[Power Cord further types to DD14](#)