

### FEATURES

- Small package:** 10-lead MSOP
- Programmable gains:** 1, 2, 4, 8
- Digital or pin-programmable gain setting**
- Wide supply:**  $\pm 5$  V to  $\pm 15$  V
- Excellent dc performance**
  - High CMRR:** 98 dB (minimum), G = 8
  - Low gain drift:** 10 ppm/ $^{\circ}$ C (maximum)
  - Low offset drift:** 1.8  $\mu$ V/ $^{\circ}$ C (maximum), G = 8
- Excellent ac performance**
  - Fast settling time:** 785 ns to 0.001% (maximum)
  - High slew rate:** 20 V/ $\mu$ s (minimum)
  - Low distortion:** -110 dB THD at 1 kHz, 10 V swing
  - High CMRR over frequency:** 80 dB to 50 kHz (minimum)
  - Low noise:** 18 nV/ $\sqrt{\text{Hz}}$ , G = 8 (maximum)
  - Low power:** 4.1 mA

### APPLICATIONS

- Data acquisition
- Biomedical analysis
- Test and measurement

### GENERAL DESCRIPTION

The AD8251 is an instrumentation amplifier with digitally programmable gains that has  $G\Omega$  input impedance, low output noise, and low distortion, making it suitable for interfacing with sensors and driving high sample rate analog-to-digital converters (ADCs). It has a high bandwidth of 10 MHz, low THD of -110 dB, and fast settling time of 785 ns (maximum) to 0.001%. Offset drift and gain drift are guaranteed to 1.8  $\mu$ V/ $^{\circ}$ C and 10 ppm/ $^{\circ}$ C, respectively, for G = 8. In addition to its wide input common voltage range, it boasts a high common-mode rejection of 80 dB at G = 1 from dc to 50 kHz. The combination of precision dc performance coupled with high speed capabilities makes the AD8251 an excellent candidate for data acquisition. Furthermore, this monolithic solution simplifies design and manufacturing and boosts performance of instrumentation by maintaining a tight match of internal resistors and amplifiers.

The AD8251 user interface consists of a parallel port that allows users to set the gain in one of two ways (see Figure 1). A 2-bit word sent via a bus can be latched using the WR input. An alternative is to use the transparent gain mode where the state of the logic levels at the gain port determines the gain.

### FUNCTIONAL BLOCK DIAGRAM

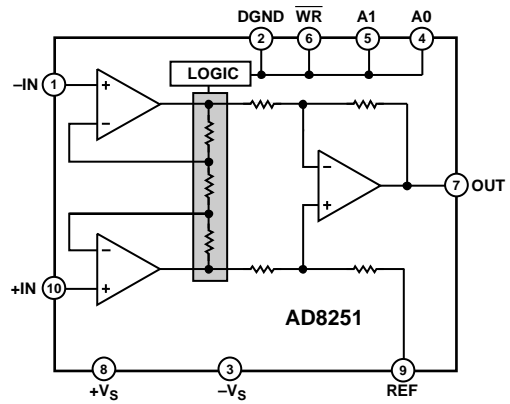

Figure 1.

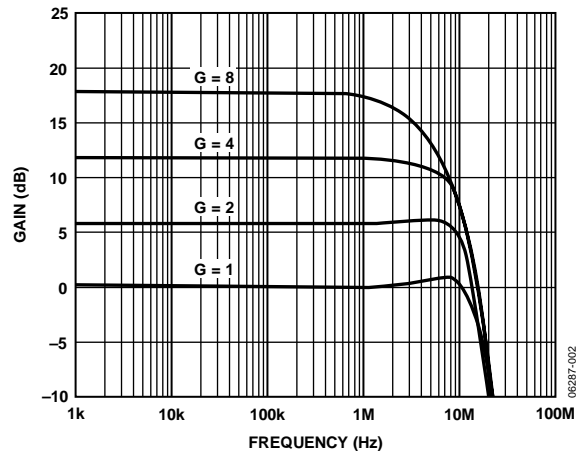

Figure 2. Gain vs. Frequency

Table 1. Instrumentation Amplifiers by Category

General Purpose	Zero Drift	Mil Grade	Low Power	High Speed PGA
AD8220 <sup>1</sup>	AD8231 <sup>1</sup>	AD620	AD627 <sup>1</sup>	AD8250
AD8221	AD8553 <sup>1</sup>	AD621	AD623 <sup>1</sup>	AD8251
AD8222	AD8555 <sup>1</sup>	AD524	AD8223 <sup>1</sup>	AD8253
AD8224 <sup>1</sup>	AD8556 <sup>1</sup>	AD526		
AD8228	AD8557 <sup>1</sup>	AD624		

<sup>1</sup> Rail-to-rail output.

The AD8251 is available in a 10-lead MSOP package and is specified over the -40 $^{\circ}$ C to +85 $^{\circ}$ C temperature range, making it an excellent solution for applications where size and packing density are important considerations.

### Rev. B

Information furnished by Analog Devices is believed to be accurate and reliable. However, no responsibility is assumed by Analog Devices for its use, nor for any infringements of patents or other rights of third parties that may result from its use. Specifications subject to change without notice. No license is granted by implication or otherwise under any patent or patent rights of Analog Devices. Trademarks and registered trademarks are the property of their respective owners.

## TABLE OF CONTENTS

Features .....	1	Power Supply Regulation and Bypassing .....	18
Applications.....	1	Input Bias Current Return Path .....	18
General Description .....	1	Input Protection .....	18
Functional Block Diagram .....	1	Reference Terminal .....	19
Revision History .....	2	Common-Mode Input Voltage Range.....	19
Specifications.....	3	Layout .....	19
Timing Diagram .....	5	RF Interference .....	20
Absolute Maximum Ratings.....	6	Driving an ADC .....	20
Maximum Power Dissipation .....	6	Applications.....	21
ESD Caution.....	6	Differential Output .....	21
Pin Configuration and Function Descriptions.....	7	Setting Gains with a Microcontroller .....	21
Typical Performance Characteristics .....	8	Data Acquisition.....	22
Theory of Operation .....	16	Outline Dimensions .....	23
Gain Selection .....	16	Ordering Guide .....	23

## REVISION HISTORY

### 11/10—Rev. A to Rev. B

Changes to Voltage Offset, Offset RTI $V_{OS}$ , Average TC	
Parameter in Table 2.....	3
Updated Outline Dimensions .....	23

### 5/08—Rev. 0 to Rev. A

Changes to Table 1.....	1
-------------------------	---

Changes to Table 2.....	3
Changes to Table 3.....	6
Inserted Figure 17; Renumbered Sequentially .....	9
Inserted Figure 29.....	11
Changes to Timing for Latched Gain Mode Section .....	17

### 5/07—Revision 0: Initial Version

## SPECIFICATIONS

+V<sub>S</sub> = 15 V, -V<sub>S</sub> = -15 V, V<sub>REF</sub> = 0 V @ T<sub>A</sub> = 25°C, G = 1, R<sub>L</sub> = 2 kΩ, unless otherwise noted.

Table 2.

Parameter	Conditions	Min	Typ	Max	Unit
<b>COMMON-MODE REJECTION RATIO (CMRR)</b>					
CMRR to 60 Hz with 1 kΩ Source Imbalance	+IN = -IN = -10 V to +10 V				
G = 1		80	98		dB
G = 2		86	104		dB
G = 4		92	110		dB
G = 8		98	110		dB
CMRR to 50 kHz	+IN = -IN = -10 V to +10 V				
G = 1		80			dB
G = 2		84			dB
G = 4		86			dB
G = 8		86			dB
<b>NOISE</b>					
Voltage Noise, 1 kHz, RTI					
G = 1				40	nV/√Hz
G = 2				27	nV/√Hz
G = 4				22	nV/√Hz
G = 8				18	nV/√Hz
0.1 Hz to 10 Hz, RTI					
G = 1				2.5	μV p-p
G = 2				2.5	μV p-p
G = 4				1.8	μV p-p
G = 8				1.2	μV p-p
Current Noise, 1 kHz			5		pA/√Hz
Current Noise, 0.1 Hz to 10 Hz			60		pA p-p
<b>VOLTAGE OFFSET</b>					
Offset RTI V <sub>OS</sub>	G = 1, 2, 4, 8		±(70 + 200/G)	±(200 + 600/G)	μV
Over Temperature	T = -40°C to +85°C		±(90 + 300/G)	±(260 + 900/G)	μV
Average TC	T = -40°C to +85°C		±(0.6 + 1.5/G)	±(1.2 + 5/G)	μV/°C
Offset Referred to the Input vs. Supply (PSR)	V <sub>S</sub> = ±5 V to ±15 V		±(2 + 7/G)	±(6 + 20/G)	μV/V
<b>INPUT CURRENT</b>					
Input Bias Current			5	30	nA
Over Temperature	T = -40°C to +85°C			40	nA
Average TC	T = -40°C to +85°C			400	pA/°C
Input Offset Current			5	30	nA
Over Temperature	T = -40°C to +85°C			30	nA
Average TC	T = -40°C to +85°C			160	pA/°C
<b>DYNAMIC RESPONSE</b>					
Small Signal -3 dB Bandwidth					
G = 1		10			MHz
G = 2		10			MHz
G = 4		8			MHz
G = 8		2.5			MHz
Settling Time 0.01%	ΔOUT = 10 V step				
G = 1				615	ns
G = 2				460	ns
G = 4				460	ns
G = 8				625	ns

# AD8251

Parameter	Conditions	Min	Typ	Max	Unit
Settling Time 0.001%	$\Delta\text{OUT} = 10\text{ V step}$			785	ns
G = 1				700	ns
G = 2				700	ns
G = 4				770	ns
G = 8					
Slew Rate					
G = 1		20			V/ $\mu\text{s}$
G = 2		30			V/ $\mu\text{s}$
G = 4		30			V/ $\mu\text{s}$
G = 8		30			V/ $\mu\text{s}$
Total Harmonic Distortion + Noise	f = 1 kHz, $R_L = 10\text{ k}\Omega$ , $\pm 10\text{ V}$ , G = 1, 10 Hz to 22 kHz band-pass filter		-110		dB
<b>GAIN</b>					
Gain Range	G = 1, 2, 4, 8	1		8	V/V
Gain Error	OUT = $\pm 10\text{ V}$			0.03	%
G = 1				0.04	%
G = 2, 4, 8					
Gain Nonlinearity	OUT = -10 V to +10 V			9	ppm
G = 1	$R_L = 10\text{ k}\Omega$ , 2 k $\Omega$ , 600 $\Omega$			12	ppm
G = 2	$R_L = 10\text{ k}\Omega$ , 2 k $\Omega$ , 600 $\Omega$			12	ppm
G = 4	$R_L = 10\text{ k}\Omega$ , 2 k $\Omega$ , 600 $\Omega$			15	ppm
G = 8	$R_L = 10\text{ k}\Omega$ , 2 k $\Omega$ , 600 $\Omega$				
Gain vs. Temperature	All gains		3	10	ppm/ $^{\circ}\text{C}$
<b>INPUT</b>					
Input Impedance					
Differential			5.3  0.5		G $\Omega$   pF
Common Mode			1.25  2		G $\Omega$   pF
Input Operating Voltage Range	$V_S = \pm 5\text{ V to } \pm 15\text{ V}$	$-V_S + 1.5$		$+V_S - 1.5$	V
Over Temperature	T = -40 $^{\circ}\text{C}$ to +85 $^{\circ}\text{C}$	$-V_S + 1.6$		$+V_S - 1.7$	V
<b>OUTPUT</b>					
Output Swing		-13.5		+13.5	V
Over Temperature	T = -40 $^{\circ}\text{C}$ to +85 $^{\circ}\text{C}$	-13.5		+13.5	V
Short-Circuit Current			37		mA
<b>REFERENCE INPUT</b>					
$R_{IN}$			20		k $\Omega$
$I_{IN}$	+IN, -IN, REF = 0			1	$\mu\text{A}$
Voltage Range		$-V_S$		$+V_S$	V
Gain to Output			$1 \pm 0.0001$		V/V
<b>DIGITAL LOGIC</b>					
Digital Ground Voltage, DGND	Referred to GND	$-V_S + 4.25$	0	$+V_S - 2.7$	V
Digital Input Voltage Low	Referred to GND	DGND		2.1	V
Digital Input Voltage High	Referred to GND	2.8		$+V_S$	V
Digital Input Current			1		$\mu\text{A}$
Gain Switching Time <sup>1</sup>				325	ns
$t_{SU}$	See Figure 3 timing diagram	20			ns
$t_{HD}$	See Figure 3 timing diagram	10			ns
$t_{\overline{WR-Low}}$	See Figure 3 timing diagram	20			ns
$t_{\overline{WR-High}}$	See Figure 3 timing diagram	40			ns

Parameter	Conditions	Min	Typ	Max	Unit
POWER SUPPLY					
Operating Range		±5		±15	V
Quiescent Current, +I <sub>s</sub>			4.1	4.5	mA
Quiescent Current, -I <sub>s</sub>			3.7	4.5	mA
Over Temperature	T = -40°C to +85°C			4.5	mA
TEMPERATURE RANGE					
Specified Performance		-40		+85	°C

<sup>1</sup> Add time for the output to slew and settle to calculate the total time for a gain change.

## TIMING DIAGRAM



Figure 3. Timing Diagram for Latched Gain Mode (See the Timing for Latched Gain Mode Section)

## ABSOLUTE MAXIMUM RATINGS

Table 3.

Parameter	Rating
Supply Voltage	±17 V
Power Dissipation	See Figure 4
Output Short-Circuit Current	Indefinite <sup>1</sup>
Common-Mode Input Voltage	+V <sub>S</sub> + 13 V to -V <sub>S</sub> - 13 V
Differential Input Voltage	+V <sub>S</sub> + 13 V, -V <sub>S</sub> - 13 V <sup>2</sup>
Digital Logic Inputs	±V <sub>S</sub>
Storage Temperature Range	-65°C to +125°C
Operating Temperature Range <sup>3</sup>	-40°C to +85°C
Lead Temperature (Soldering, 10 sec)	300°C
Junction Temperature	140°C
θ <sub>JA</sub> (Four-Layer JEDEC Standard Board)	112°C/W
Package Glass Transition Temperature	140°C

<sup>1</sup> Assumes the load is referenced to midsupply.

<sup>2</sup> Current must be kept to less than 6 mA.

<sup>3</sup> Temperature for specified performance is -40°C to +85°C. For performance to +125°C, see the Typical Performance Characteristics section.

Stresses above those listed under Absolute Maximum Ratings may cause permanent damage to the device. This is a stress rating only; functional operation of the device at these or any other conditions above those indicated in the operational section of this specification is not implied. Exposure to absolute maximum rating conditions for extended periods may affect device reliability.

### MAXIMUM POWER DISSIPATION

The maximum safe power dissipation in the AD8251 package is limited by the associated rise in junction temperature (T<sub>J</sub>) on the die. The plastic encapsulating the die locally reaches the junction temperature. At approximately 140°C, which is the glass transition temperature, the plastic changes its properties. Even temporarily exceeding this temperature limit can change the stresses that the package exerts on the die, permanently shifting the parametric performance of the AD8251. Exceeding a junction temperature of 140°C for an extended period can result in changes in silicon devices, potentially causing failure.

The still air thermal properties of the package and PCB (θ<sub>JA</sub>), the ambient temperature (T<sub>A</sub>), and the total power dissipated in the package (P<sub>D</sub>) determine the junction temperature of the die. The junction temperature is calculated as

$$T_J = T_A + (P_D \times \theta_{JA})$$

The power dissipated in the package (P<sub>D</sub>) is the sum of the quiescent power dissipation and the power dissipated in the package due to the load drive for all outputs. The quiescent power is the voltage between the supply pins (V<sub>S</sub>) times the quiescent current (I<sub>S</sub>). Assuming the load (R<sub>L</sub>) is referenced to midsupply, the total drive power is V<sub>S</sub>/2 × I<sub>OUT</sub>, some of which is dissipated in the package and some in the load (V<sub>OUT</sub> × I<sub>OUT</sub>).

The difference between the total drive power and the load power is the drive power dissipated in the package.

$$P_D = \text{Quiescent Power} + (\text{Total Drive Power} - \text{Load Power})$$

$$P_D = (V_S \times I_S) + \left( \frac{V_S}{2} \times \frac{V_{OUT}}{R_L} \right) - \frac{V_{OUT}^2}{R_L}$$

In single-supply operation with R<sub>L</sub> referenced to -V<sub>S</sub>, the worst case is V<sub>OUT</sub> = V<sub>S</sub>/2.

Airflow increases heat dissipation, effectively reducing θ<sub>JA</sub>. In addition, more metal directly in contact with the package leads from metal traces, through holes, ground, and power planes reduces the θ<sub>JA</sub>.

Figure 4 shows the maximum safe power dissipation in the package vs. the ambient temperature on a four-layer JEDEC standard board.

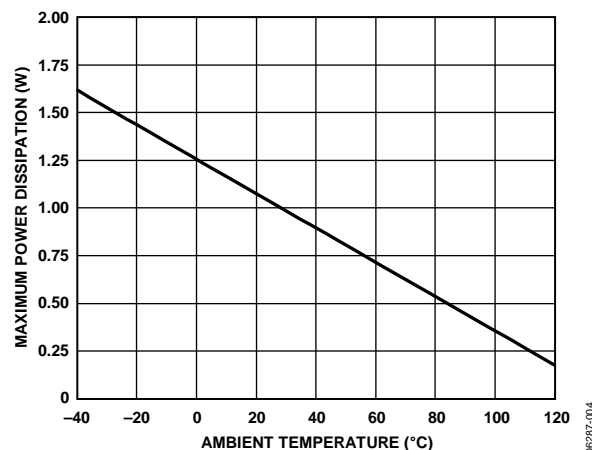

Figure 4. Maximum Power Dissipation vs. Ambient Temperature

### ESD CAUTION



#### ESD (electrostatic discharge) sensitive device.

Charged devices and circuit boards can discharge without detection. Although this product features patented or proprietary protection circuitry, damage may occur on devices subjected to high energy ESD. Therefore, proper ESD precautions should be taken to avoid performance degradation or loss of functionality.

## PIN CONFIGURATION AND FUNCTION DESCRIPTIONS



Figure 5. Pin Configuration

Table 4. Pin Function Descriptions

Pin No.	Mnemonic	Description
1	-IN	Inverting Input Terminal. True differential input.
2	DGND	Digital Ground.
3	-Vs	Negative Supply Terminal.
4	A0	Gain Setting Pin (LSB).
5	A1	Gain Setting Pin (MSB).
6	$\overline{\text{WR}}$	Write Enable.
7	OUT	Output Terminal.
8	+Vs	Positive Supply Terminal.
9	REF	Reference Voltage Terminal.
10	+IN	Noninverting Input Terminal. True differential input.

## TYPICAL PERFORMANCE CHARACTERISTICS

$T_A = 25^\circ\text{C}$ ,  $+V_S = +15\text{ V}$ ,  $-V_S = -15\text{ V}$ ,  $R_L = 10\text{ k}\Omega$ , unless otherwise noted.



Figure 6. Typical Distribution of CMRR,  $G = 1$

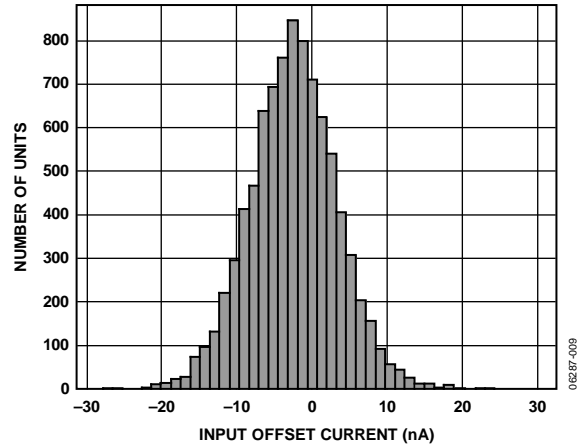

Figure 9. Typical Distribution of Input Offset Current

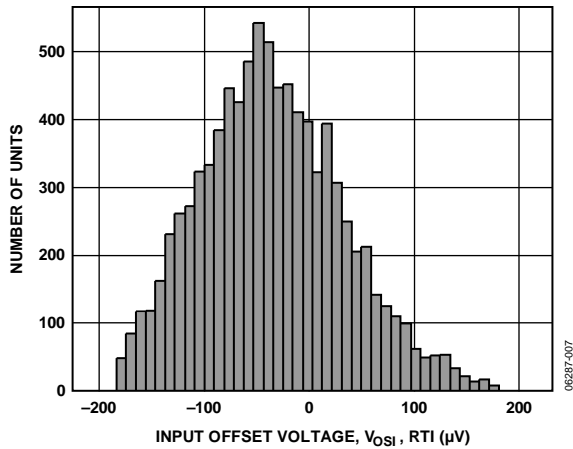

Figure 7. Typical Distribution of Offset Voltage,  $V_{OS1}$

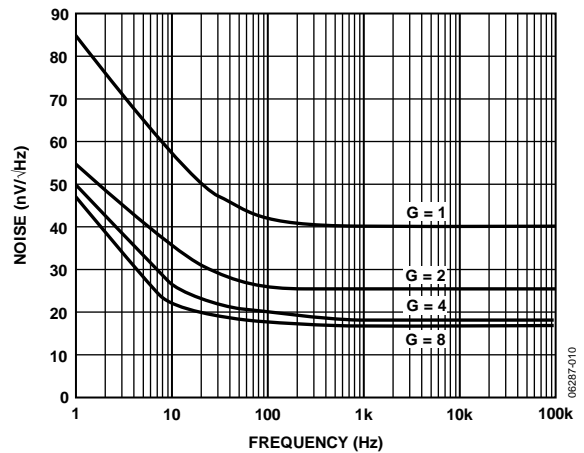

Figure 10. Voltage Spectral Density Noise vs. Frequency

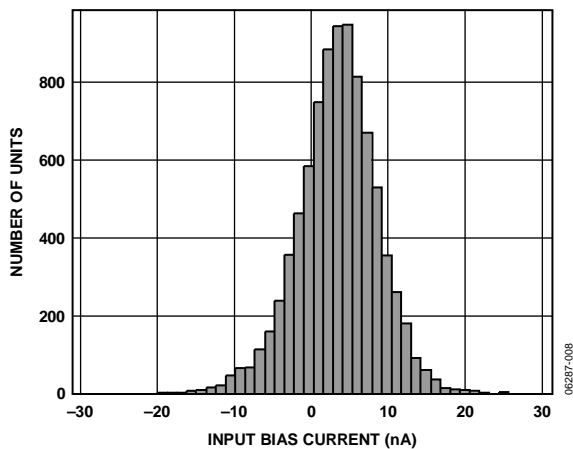

Figure 8. Typical Distribution of Input Bias Current

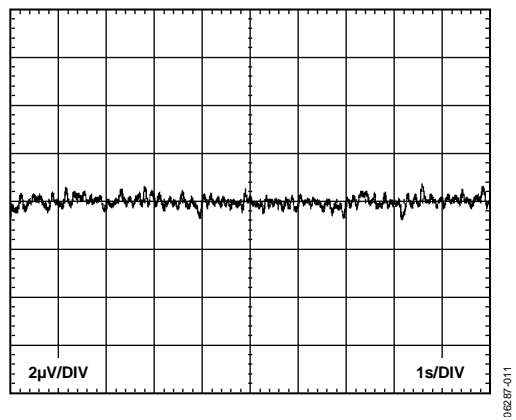

Figure 11. 0.1 Hz to 10 Hz RTI Voltage Noise,  $G = 1$





Figure 12. 0.1 Hz to 10 Hz RTI Voltage Noise, G = 8

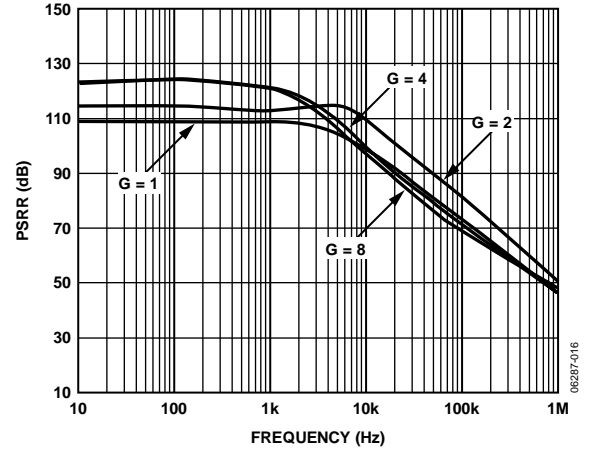

Figure 15. Positive PSRR vs. Frequency, RTI

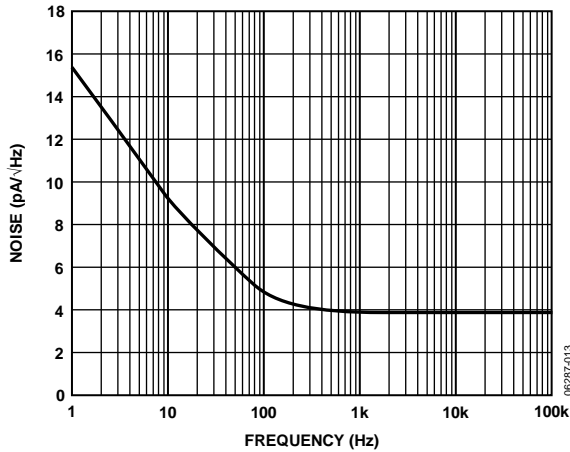

Figure 13. Current Noise Spectral Density vs. Frequency

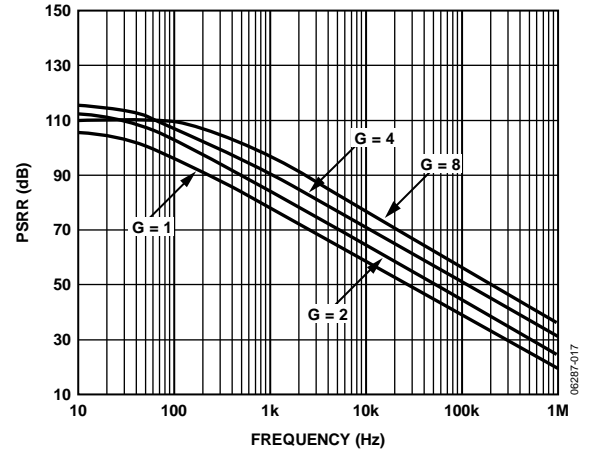

Figure 16. Negative PSRR vs. Frequency, RTI



Figure 14. 0.1 Hz to 10 Hz Current Noise

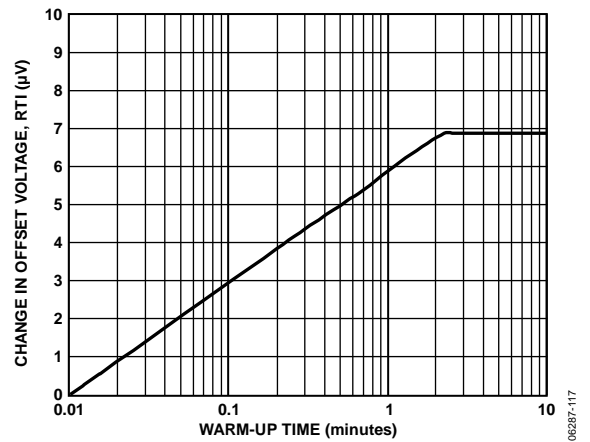

Figure 17. Change in Offset Voltage, RTI vs. Warmup Time

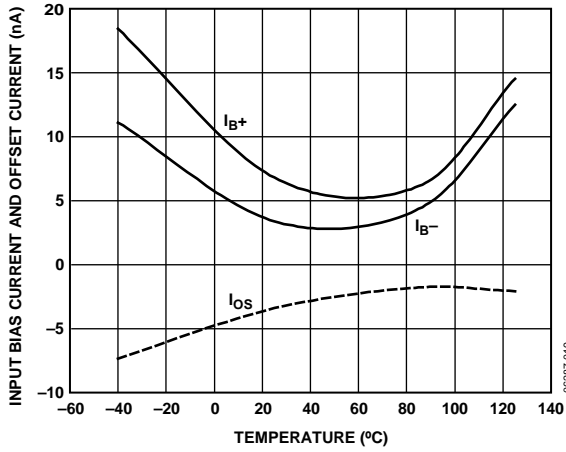

Figure 18. Input Bias Current and Offset Current vs. Temperature

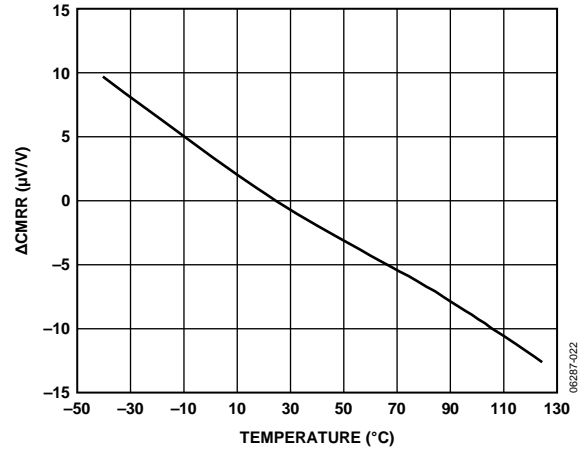

Figure 21.  $\Delta CMRR$  vs. Temperature,  $G = 1$

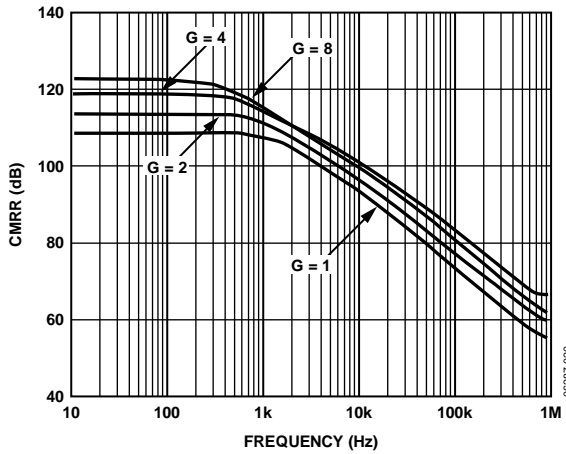

Figure 19. CMRR vs. Frequency

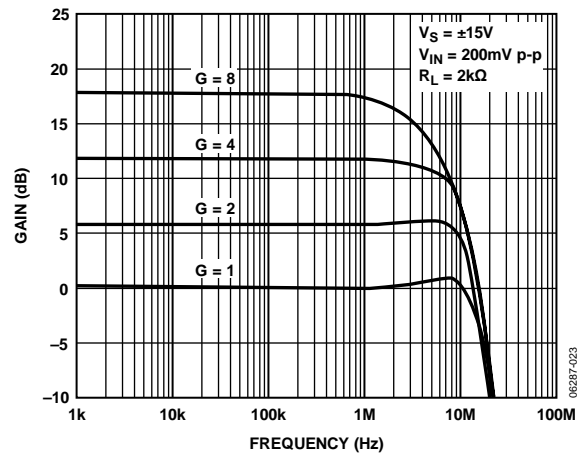

Figure 22. Gain vs. Frequency

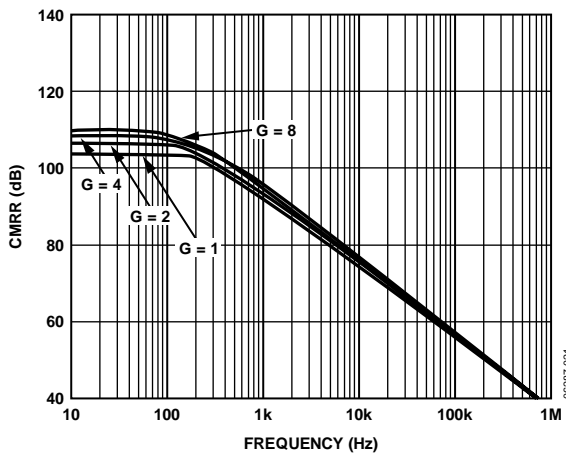

Figure 20. CMRR vs. Frequency, 1 k $\Omega$  Source Imbalance

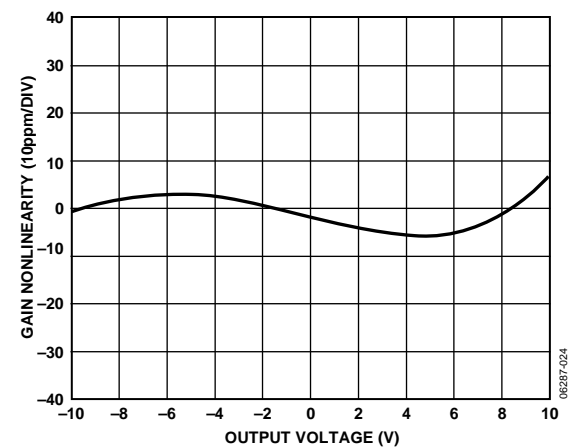

Figure 23. Gain Nonlinearity vs. Output Voltage,  $G = 1$ ,  $R_L = 10k\Omega, 2k\Omega, 600\Omega$

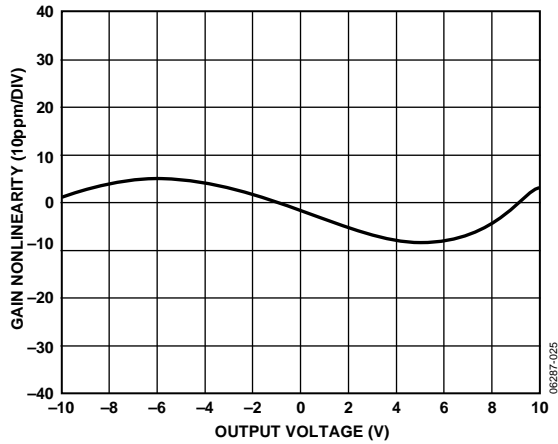

Figure 24. Gain Nonlinearity vs. Output Voltage,  $G = 2$ ,  $R_L = 10\text{ k}\Omega$ ,  $2\text{ k}\Omega$ ,  $600\Omega$



Figure 27. Input Common-Mode Voltage Range vs. Output Voltage,  $G = 1$

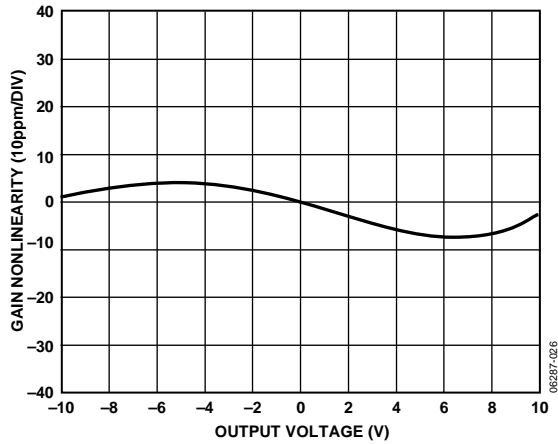

Figure 25. Gain Nonlinearity vs. Output Voltage,  $G = 4$ ,  $R_L = 10\text{ k}\Omega$ ,  $2\text{ k}\Omega$ ,  $600\Omega$



Figure 28. Input Common-Mode Voltage Range vs. Output Voltage,  $G = 8$

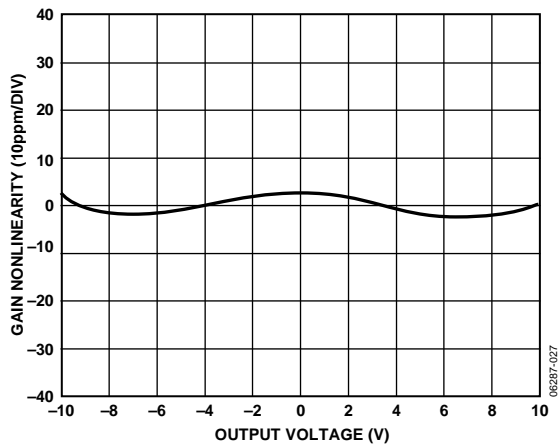

Figure 26. Gain Nonlinearity vs. Output Voltage,  $G = 8$ ,  $R_L = 10\text{ k}\Omega$ ,  $2\text{ k}\Omega$ ,  $600\Omega$



Figure 29. Input Bias Current and Offset Current vs. Common-Mode Voltage

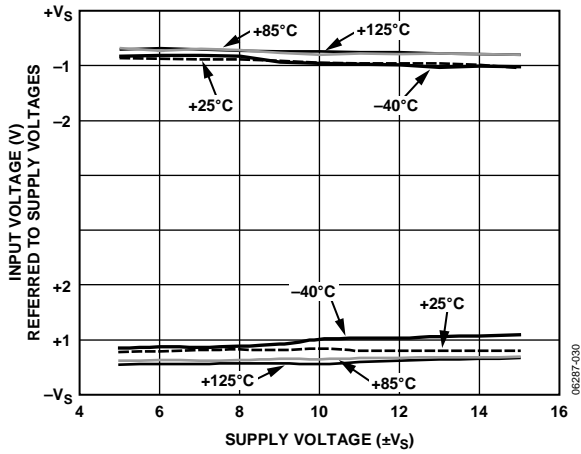

Figure 30. Input Voltage Limit vs. Supply Voltage,  $G = 1$ ,  $V_{REF} = 0V$ ,  $R_L = 10k\Omega$

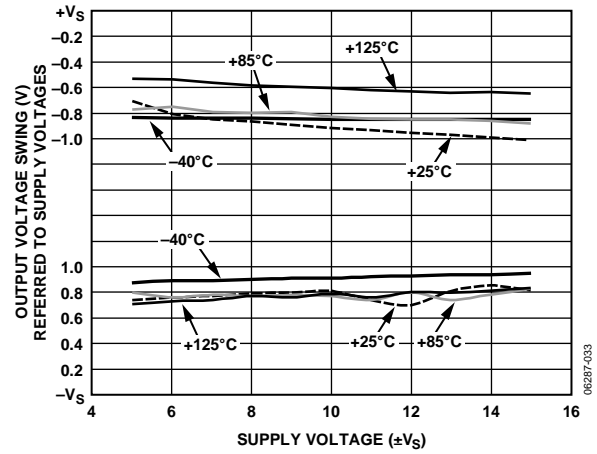

Figure 33. Output Voltage Swing vs. Supply Voltage,  $G = 8$ ,  $R_L = 10k\Omega$

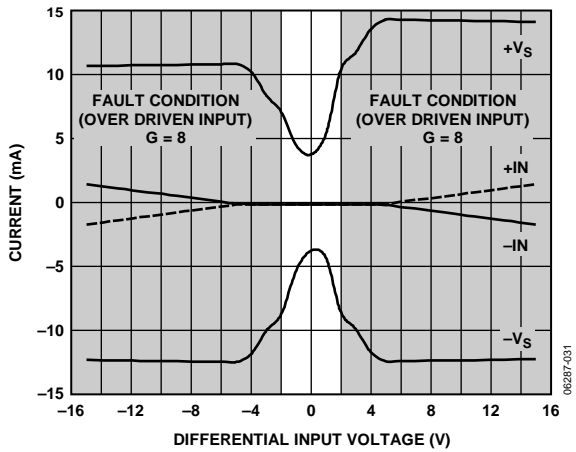

Figure 31. Fault Current Draw vs. Input Voltage,  $G = 8$ ,  $R_L = 10k\Omega$

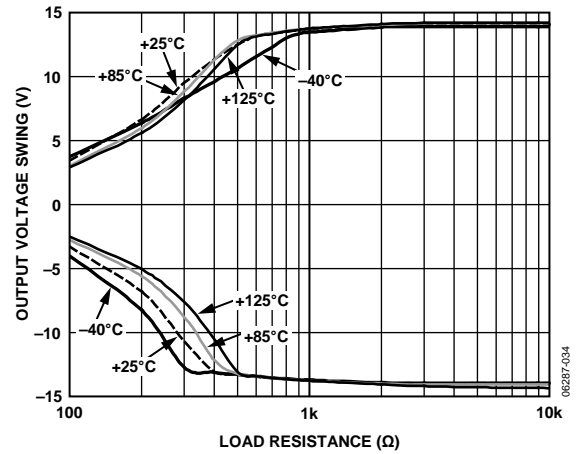

Figure 34. Output Voltage Swing vs. Load Resistance

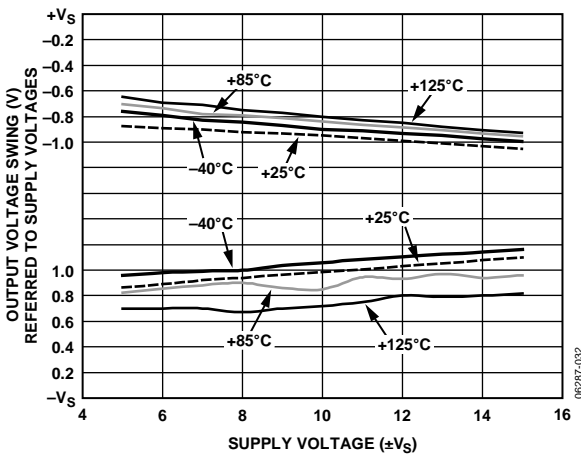

Figure 32. Output Voltage Swing vs. Supply Voltage,  $G = 8$ ,  $R_L = 2k\Omega$

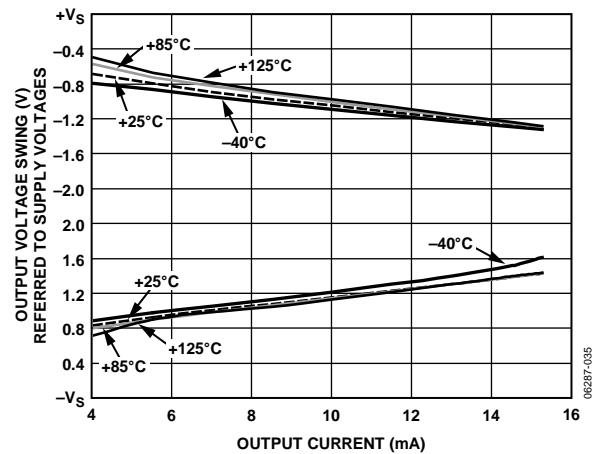

Figure 35. Output Voltage Swing vs. Output Current

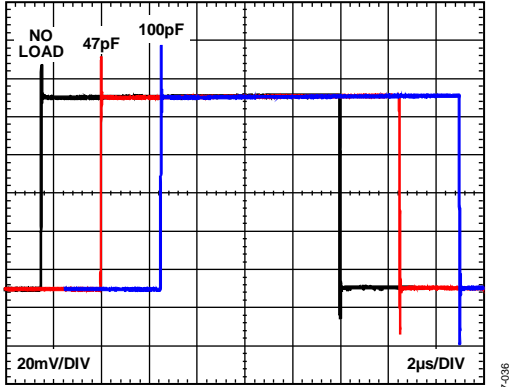

Figure 36. Small Signal Pulse Response for Various Capacitive Loads

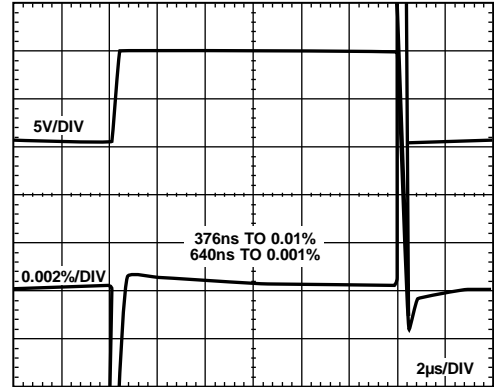

Figure 39. Large Signal Pulse Response and Settling Time,  $G = 4, R_L = 10 \text{ k}\Omega$

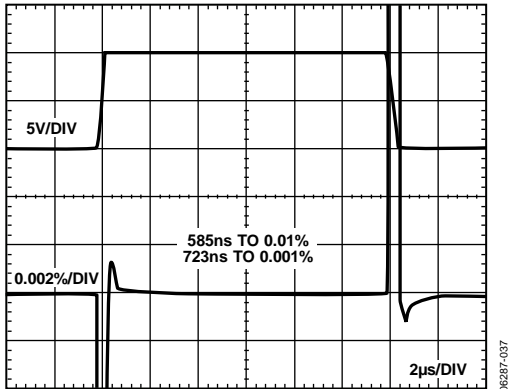

Figure 37. Large Signal Pulse Response and Settling Time,  $G = 1, R_L = 10 \text{ k}\Omega$

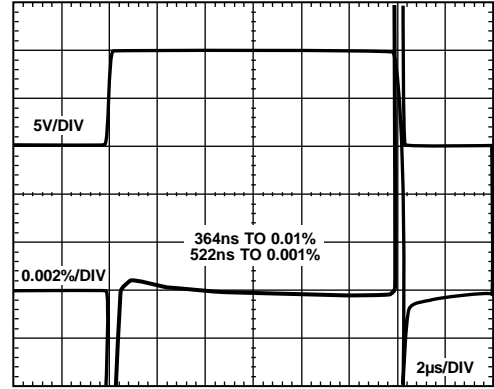

Figure 40. Large Signal Pulse Response and Settling Time,  $G = 8, R_L = 10 \text{ k}\Omega$

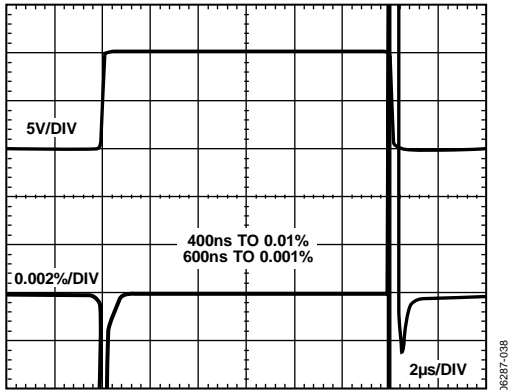

Figure 38. Large Signal Pulse Response and Settling Time,  $G = 2, R_L = 10 \text{ k}\Omega$

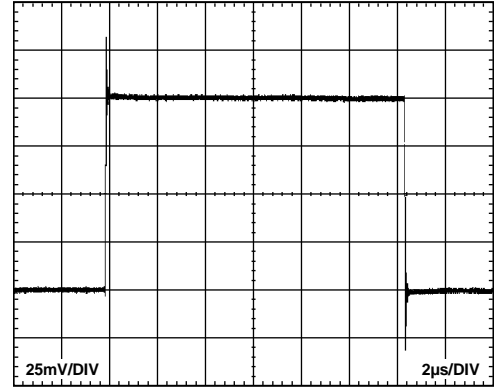

Figure 41. Small Signal Response,  $G = 1, R_L = 2 \text{ k}\Omega, C_L = 100 \text{ pF}$



Figure 42. Small Signal Response,  
 $G = 2, R_L = 2 \text{ k}\Omega, C_L = 100 \text{ pF}$

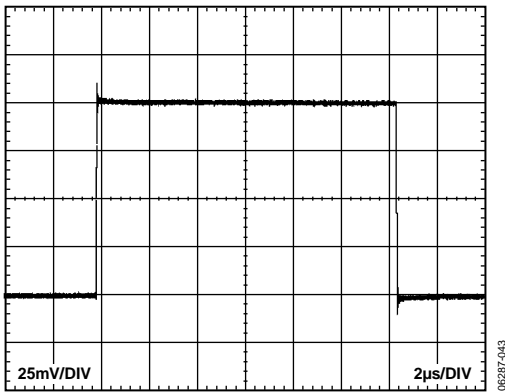

Figure 43. Small Signal Response,  
 $G = 4, R_L = 2 \text{ k}\Omega, C_L = 100 \text{ pF}$



Figure 44. Small Signal Response,  
 $G = 8, R_L = 2 \text{ k}\Omega, C_L = 100 \text{ pF}$



Figure 45. Settling Time vs. Step Size,  $G = 1, R_L = 10 \text{ k}\Omega$

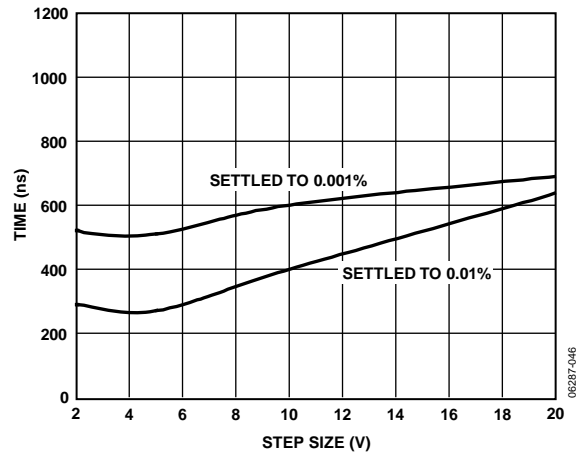

Figure 46. Settling Time vs. Step Size,  $G = 2, R_L = 10 \text{ k}\Omega$



Figure 47. Settling Time vs. Step Size,  $G = 4, R_L = 10 \text{ k}\Omega$



Figure 48. Settling Time vs. Step Size,  $G = 8$ ,  $R_L = 10\text{ k}\Omega$



Figure 50. Total Harmonic Distortion + Noise vs. Frequency, 10 Hz to 500 kHz Band-Pass Filter,  $R_L = 2\text{ k}\Omega$



Figure 49. Total Harmonic Distortion + Noise vs. Frequency, 10 Hz to 22 kHz Band-Pass Filter,  $R_L = 2\text{ k}\Omega$

## THEORY OF OPERATION



Figure 51. Simplified Schematic

The AD8251 is a monolithic instrumentation amplifier based on the classic 3-op-amp topology, as shown in Figure 51. It is fabricated on the Analog Devices, Inc., proprietary *iCMOS*® process that provides precision, linear performance, and a robust digital interface. A parallel interface allows users to digitally program gains of 1, 2, 4, and 8. Gain control is achieved by switching resistors in an internal, precision resistor array (as shown in Figure 51). Although the AD8251 has a voltage feedback topology, the gain bandwidth product increases for gains of 1, 2, and 4 because each gain has its own frequency compensation. This results in maximum bandwidth at higher gains.

All internal amplifiers employ distortion cancellation circuitry and achieve high linearity and ultralow THD. Laser trimmed resistors allow for a maximum gain error of less than 0.03% for  $G = 1$  and minimum CMRR of 98 dB for  $G = 8$ . A pinout optimized for high CMRR over frequency enables the AD8251 to offer a guaranteed minimum CMRR over frequency of 80 dB at 50 kHz ( $G = 1$ ). The balanced input reduces the parasitics that, in the past, adversely affected CMRR performance.

## GAIN SELECTION

Logic low and logic high voltage limits are listed in the Specifications section. Typically, logic low is 0 V and logic high is 5 V; both voltages are measured with respect to DGND. See Table 2 for the permissible voltage range of DGND. The gain of the AD8251 can be set using two methods.

## Transparent Gain Mode

The easiest way to set the gain is to program it directly via a logic high or logic low voltage applied to A0 and A1. Figure 52 shows an example of this gain setting method, referred to throughout the data sheet as transparent gain mode. Tie  $\overline{WR}$  to the negative supply to engage transparent gain mode. In this mode, any change in voltage applied to A0 and A1 from logic low to logic high, or vice versa, immediately results in a gain change. Table 5 is the truth table for transparent gain mode, and Figure 52 shows the AD8251 configured in transparent gain mode.

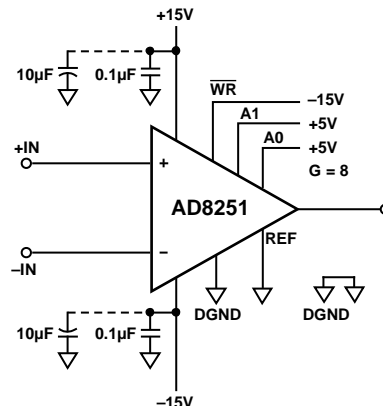

**NOTE:**  
1. IN TRANSPARENT GAIN MODE,  $\overline{WR}$  IS TIED TO  $-V_S$ . THE VOLTAGE LEVELS ON A0 AND A1 DETERMINE THE GAIN. IN THIS EXAMPLE, BOTH A0 AND A1 ARE SET TO LOGIC HIGH, RESULTING IN A GAIN OF 8.

Figure 52. Transparent Gain Mode, A0 and A1 = High,  $G = 8$

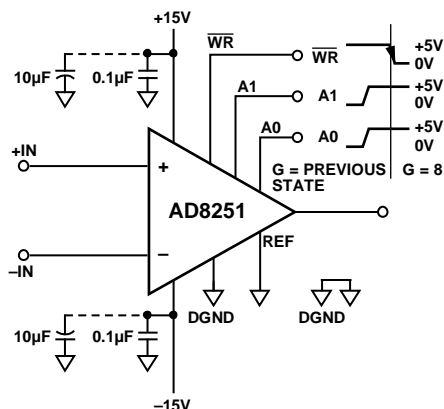

Table 5. Truth Table Logic Levels for Transparent Gain Mode

WR	A1	A0	Gain
-V <sub>S</sub>	Low	Low	1
-V <sub>S</sub>	Low	High	2
-V <sub>S</sub>	High	Low	4
-V <sub>S</sub>	High	High	8

**Latched Gain Mode**

Some applications have multiple programmable devices such as multiplexers or other programmable gain instrumentation amplifiers on the same PCB. In such cases, devices can share a data bus. The gain of the AD8251 can be set using  $\overline{WR}$  as a latch, allowing other devices to share A0 and A1. Figure 53 shows a schematic using this method, known as latched gain mode. The AD8251 is in this mode when  $\overline{WR}$  is held at logic high or logic low, typically 5 V and 0 V, respectively. The voltages on A0 and A1 are read on the downward edge of the  $\overline{WR}$  signal as it transitions from logic high to logic low. This latches in the logic levels on A0 and A1, resulting in a gain change. See the truth table in Table 6 for more information on these gain changes.



NOTE:  
1. ON THE DOWNWARD EDGE OF  $\overline{WR}$ , AS IT TRANSITIONS FROM LOGIC HIGH TO LOGIC LOW, THE VOLTAGES ON A0 AND A1 ARE READ AND LATCHED IN, RESULTING IN A GAIN CHANGE. IN THIS EXAMPLE, THE GAIN SWITCHES TO G = 8.

Figure 53. Latched Gain Mode, G = 8

Table 6. Truth Table Logic Levels for Latched Gain Mode

WR	A1	A0	Gain
High to low	Low	Low	Change to 1
High to low	Low	High	Change to 2
High to low	High	Low	Change to 4
High to low	High	High	Change to 8
Low to low	X <sup>1</sup>	X <sup>1</sup>	No change
Low to high	X <sup>1</sup>	X <sup>1</sup>	No change
High to high	X <sup>1</sup>	X <sup>1</sup>	No change

<sup>1</sup> X = don't care.

On power-up, the AD8251 defaults to a gain of 1 when in latched gain mode. In contrast, if the AD8251 is configured in transparent gain mode, it starts at the gain indicated by the voltage levels on A0 and A1 at power-up.

**Timing for Latched Gain Mode**

In latched gain mode, logic levels at A0 and A1 must be held for a minimum setup time,  $t_{SU}$ , before the downward edge of  $\overline{WR}$  latches in the gain. Similarly, they must be held for a minimum hold time of  $t_{HD}$  after the downward edge of  $\overline{WR}$  to ensure that the gain is latched in correctly. After  $t_{HD}$ , A0 and A1 can change logic levels, but the gain does not change (until the next downward edge of  $\overline{WR}$ ). The minimum duration that  $\overline{WR}$  can be held high is  $t_{\overline{WR-HIGH}}$ , and the minimum duration that  $\overline{WR}$  can be held low is  $t_{\overline{WR-LOW}}$ . Digital timing specifications are listed in Table 2. The time required for a gain change is dominated by the settling time of the amplifier. A timing diagram is shown in Figure 54.

When sharing a data bus with other devices, logic levels applied to those devices can potentially feed through to the output of the AD8251. Feedthrough can be minimized by decreasing the edge rate of the logic signals. Furthermore, careful layout of the PCB also reduces coupling between the digital and analog portions of the board. Pull-up or pull-down resistors should be used to provide a well-defined voltage at the A0 and A1 pins.



Figure 54. Timing Diagram for Latched Gain Mode

# AD8251

## POWER SUPPLY REGULATION AND BYPASSING

The AD8251 has high PSRR. However, for optimal performance, a stable dc voltage should be used to power the instrumentation amplifier. Noise on the supply pins can adversely affect performance. As in all linear circuits, bypass capacitors must be used to decouple the amplifier.

Place a 0.1  $\mu\text{F}$  capacitor close to each supply pin. A 10  $\mu\text{F}$  tantalum capacitor can be used farther away from the part (see Figure 55) and, in most cases, it can be shared by other precision integrated circuits.



Figure 55. Supply Decoupling, REF, and Output Referred to Ground

## INPUT BIAS CURRENT RETURN PATH

The AD8251 input bias current must have a return path to its local analog ground. When the source, such as a thermocouple, cannot provide a return current path, one should be created (see Figure 56).



Figure 56. Creating an  $I_{BIAS}$  Return Path

## INPUT PROTECTION

All terminals of the AD8251 are protected against ESD. Note that 2.2 k $\Omega$  series resistors precede the ESD diodes as shown in Figure 51. The resistors limit current into the diodes and allow for dc overload conditions 13 V above the positive supply and 13 V below the negative supply. An external resistor should be used in series with each input to limit current for voltages greater than 13 V beyond either supply rail. In either scenario, the AD8251 safely handles a continuous 6 mA current at room temperature. For applications where the AD8251 encounters extreme overload voltages, external series resistors and low leakage diode clamps, such as BAV199Ls, FJH1100s, or SP720s, should be used.

## REFERENCE TERMINAL

The reference terminal, REF, is at one end of a 10 k $\Omega$  resistor (see Figure 51). The instrumentation amplifier output is referenced to the voltage on the REF terminal; this is useful when the output signal needs to be offset to voltages other than its local analog ground. For example, a voltage source can be tied to the REF pin to level shift the output so that the AD8251 can interface with a single-supply ADC. The allowable reference voltage range is a function of the gain, common-mode input, and supply voltages. The REF pin should not exceed either  $+V_S$  or  $-V_S$  by more than 0.5 V.

For best performance, especially in cases where the output is not measured with respect to the REF terminal, source impedance to the REF terminal should be kept low because parasitic resistance can adversely affect CMRR and gain accuracy.

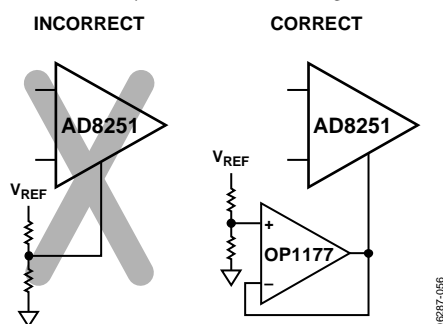

Figure 57. Driving the Reference Pin

## COMMON-MODE INPUT VOLTAGE RANGE

The 3-op-amp architecture of the AD8251 applies gain and then removes the common-mode voltage. Therefore, internal nodes in the AD8251 experience a combination of both the gained signal and the common-mode signal. This combined signal can be limited by the voltage supplies even when the individual input and output signals are not. Figure 27 and Figure 28 show the allowable common-mode input voltage ranges for various output voltages, supply voltages, and gains.

## LAYOUT

### Grounding

In mixed-signal circuits, low level analog signals need to be isolated from the noisy digital environment. Designing with the AD8251 is no exception. Its supply voltages are referenced to an analog ground. Its digital circuit is referenced to a digital ground. Although it is convenient to tie both grounds to a single ground plane, the current traveling through the ground wires and PCB can cause errors. Therefore, use separate analog and digital ground planes. Analog and digital ground should meet at one point only: star ground.

The output voltage of the AD8251 develops with respect to the potential on the reference terminal. Take care to tie REF to the appropriate local analog ground or to connect it to a voltage that is referenced to the local analog ground.

### Coupling Noise

To prevent coupling noise onto the AD8251, follow these guidelines:

- Do not run digital lines under the device.
- Run the analog ground plane under the AD8251.
- Shield fast switching signals with digital ground to avoid radiating noise to other sections of the board, and never run them near analog signal paths.
- Avoid crossover of digital and analog signals.
- Connect digital and analog ground at one point only (typically under the ADC).
- Use large traces on the power supply lines to ensure a low impedance path. Decoupling is necessary; follow the guidelines listed in the Power Supply Regulation and Bypassing section.

### Common-Mode Rejection

The AD8251 has high CMRR over frequency, giving it greater immunity to disturbances, such as line noise and its associated harmonics, in contrast to typical instrumentation amplifiers whose CMRR falls off around 200 Hz. The typical instrumentation amplifiers often need common-mode filters at their inputs to compensate for this shortcoming. The AD8251 is able to reject CMRR over a greater frequency range, reducing the need for input common-mode filtering.

Careful board layout maximizes system performance. To maintain high CMRR over frequency, lay out the input traces symmetrically. Ensure that the traces maintain resistive and capacitive balance; this holds for additional PCB metal layers under the input pins and traces. Source resistance and capacitance should be placed as close to the inputs as possible. Should a trace cross the inputs (from another layer), it should be routed perpendicular to the input traces.

# AD8251

## RF INTERFERENCE

RF rectification is often a problem when amplifiers are used in applications where there are strong RF signals. The disturbance can appear as a small dc offset voltage. High frequency signals can be filtered with a low-pass RC network placed at the input of the instrumentation amplifier, as shown in Figure 58. The filter limits the input signal bandwidth according to the following relationship:

$$FilterFreq_{DIFF} = \frac{1}{2 \pi R(2C_D + C_C)}$$

$$FilterFreq_{CM} = \frac{1}{2 \pi RC_C}$$

where  $C_D \geq 10 C_C$ .



Figure 58. RFI Suppression

Values of R and  $C_C$  should be chosen to minimize RFI. A mismatch between the  $R \times C_C$  at the positive input and the  $R \times C_C$  at negative input degrades the CMRR of the AD8251. By using a value of  $C_D$  that is 10 times larger than the value of  $C_C$ , the effect of the mismatch is reduced and performance is improved.

## DRIVING AN ADC

An instrumentation amplifier is often used in front of an ADC to provide CMRR. Usually, instrumentation amplifiers require a buffer to drive an ADC. However, the low output noise, low distortion, and low settle time of the AD8251 make it an excellent ADC driver.

In Figure 59, a 1 nF capacitor and a 49.9  $\Omega$  resistor create an antialiasing filter for the AD7612. The 1 nF capacitor stores and delivers the necessary charge to the switched capacitor input of the ADC. The 49.9  $\Omega$  series resistor reduces the burden of the 1 nF load from the amplifier and isolates it from the kickback current injected from the switched capacitor input of the AD7612. Selecting too small a resistor improves the correlation between the voltage at the output of the AD8251 and the voltage at the input of the AD7612 but may destabilize the AD8251. A trade-off must be made between selecting a resistor small enough to maintain accuracy and large enough to maintain stability.



Figure 59. Driving an ADC

# APPLICATIONS

## DIFFERENTIAL OUTPUT

In certain applications, it is necessary to create a differential signal. High resolution ADCs often require a differential input. In other cases, transmission over a long distance can require differential signals for better immunity to interference.

Figure 61 shows how to configure the AD8251 to output a differential signal. An op amp, the AD817, is used in an inverting topology to create a differential voltage.  $V_{REF}$  sets the output midpoint according to the equation shown in the figure. Errors from the op amp are common to both outputs and are thus common mode. Likewise, errors from using mismatched resistors cause a common-mode dc offset error. Such errors are rejected in differential signal processing by differential input ADCs or instrumentation amplifiers.

When using this circuit to drive a differential ADC,  $V_{REF}$  can be set using a resistor divider from the ADC reference to make the output ratiometric with the ADC.

## SETTING GAINS WITH A MICROCONTROLLER

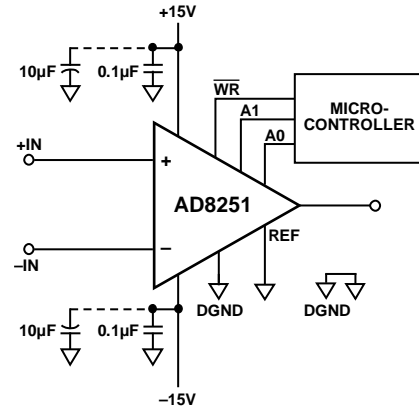

Figure 60. Programming Gain Using a Microcontroller

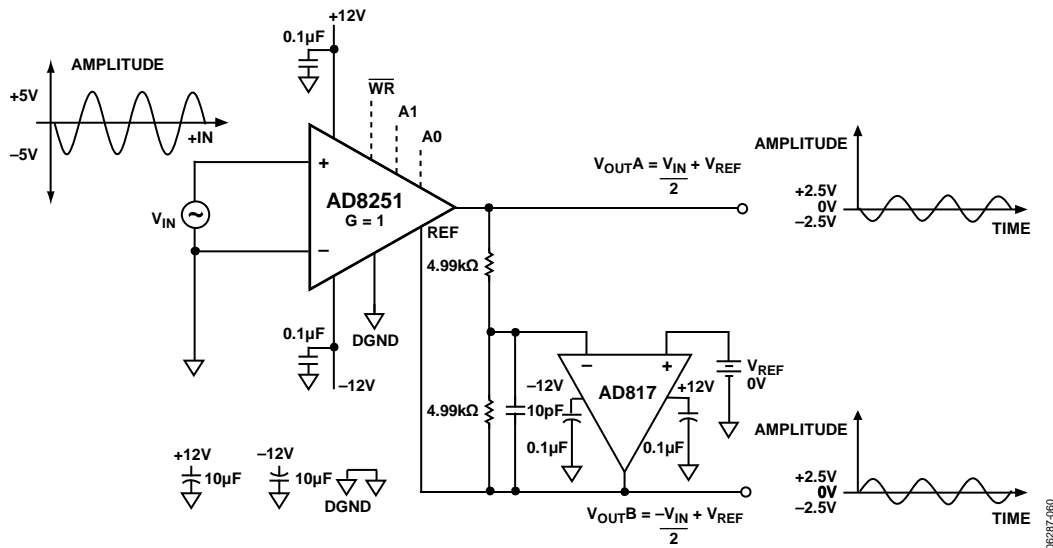

Figure 61. Differential Output with Level Shift

# AD8251

## DATA ACQUISITION

The AD8251 makes an excellent instrumentation amplifier for use in data acquisition systems. Its wide bandwidth, low distortion, low settling time, and low noise enable it to condition signals in front of a variety of 16-bit ADCs.

Figure 63 shows a schematic of the AD825x data acquisition demonstration board. The quick slew rate of the AD8251 allows it to condition rapidly changing signals from the multiplexed inputs. An FPGA controls the AD7612, AD8251, and ADG1209. In addition, mechanical switches and jumpers allow users to pin strap the gains when in transparent gain mode.

This system achieved  $-106$  dB of THD at 1 kHz and a signal-to-noise ratio of 91 dB during testing, as shown in Figure 62.



Figure 62. FFT of the AD825x DAQ Demo Board Using the AD8251 1 kHz Signal

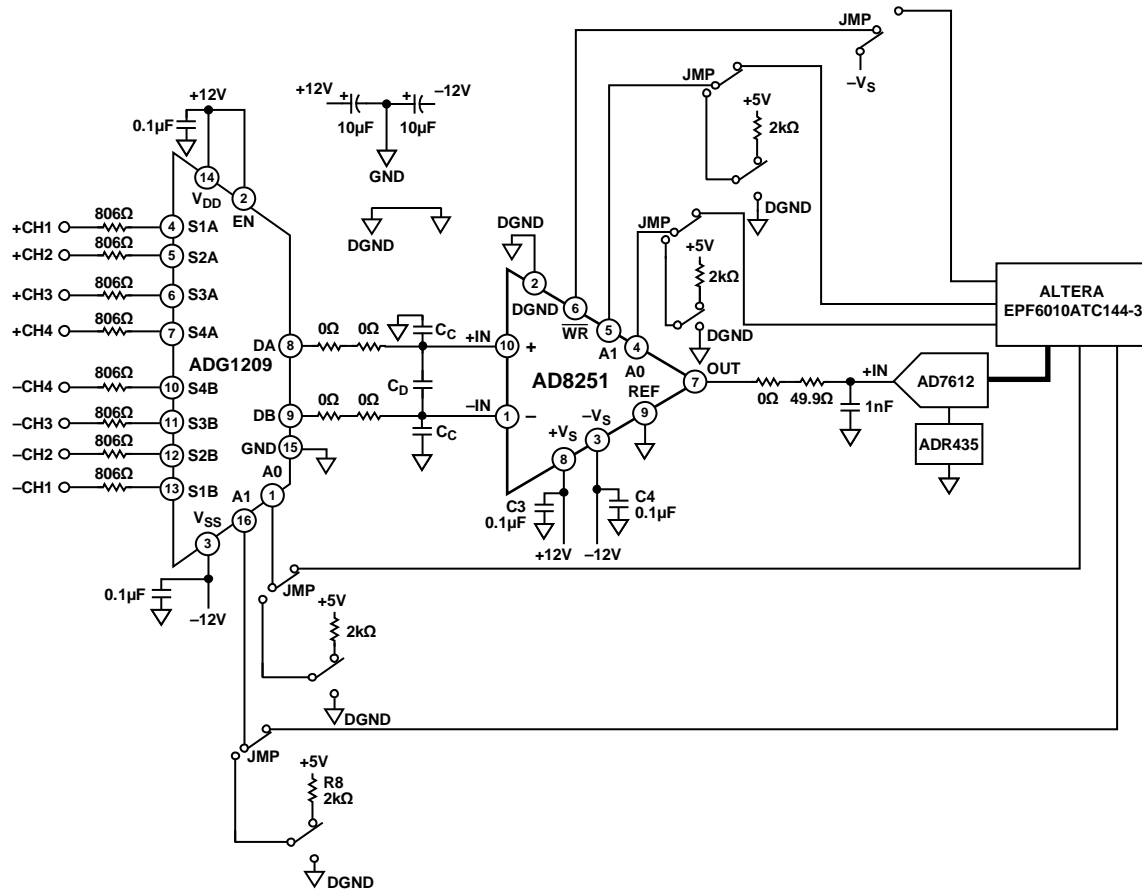
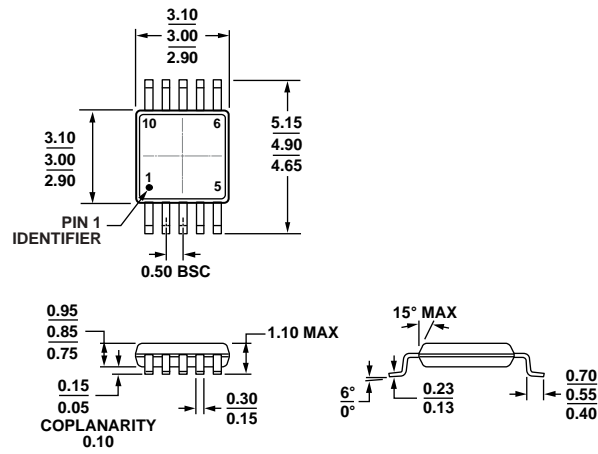

Figure 63. Schematic of ADG1209, AD8251, and AD7612 in the AD825x DAQ Demo Board

# OUTLINE DIMENSIONS



COMPLIANT TO JEDEC STANDARDS MO-187-BA

Figure 64. 10-Lead Mini Small Outline Package [MSOP] (RM-10)

Dimensions shown in millimeters

091709-A

## ORDERING GUIDE

Model <sup>1</sup>	Temperature Range	Package Description	Package Option	Branding
AD8251ARMZ	-40°C to +85°C	10-Lead Mini Small Outline Package [MSOP]	RM-10	HOT
AD8251ARMZ-RL	-40°C to +85°C	10-Lead Mini Small Outline Package [MSOP]	RM-10	HOT
AD8251ARMZ-R7	-40°C to +85°C	10-Lead Mini Small Outline Package [MSOP]	RM-10	HOT
AD8251-EVALZ		Evaluation Board		

<sup>1</sup> Z = RoHS Compliant Part.

**AD8251**

**NOTES**