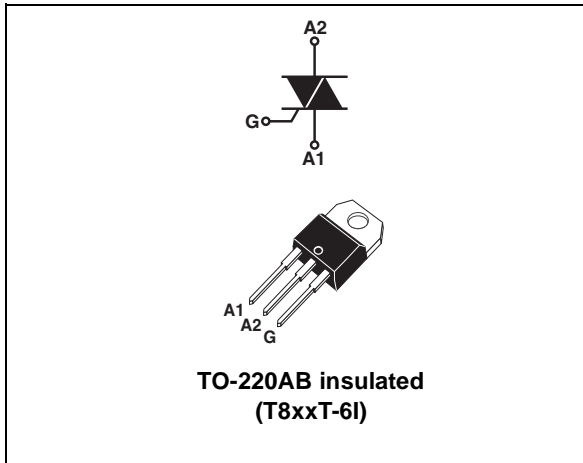

Snubberless™, logic level and standard 8 A Triacs

Datasheet - production data

Table 1. Device summary

Part number	Symbol	Value
T810T-6I	I _{GT} 3Q logic level	10 mA
T820T-6I T835T-6I	I _{GT} 3Q Snubberless	20 / 35 mA
T825T-6I	I _{GT} 4Q standard	25 mA

Features

- Medium current Triac
- High static and dynamic commutation
- Low thermal resistance with clip bonding
- Packages is RoHS (2002/95/EC) compliant
- 600 V V_{RM}
- UL certified (ref. file E81734)

Applications

- Value sensitive application
- General purpose ac line load switching
- Motor control circuits in power tools
- Small home appliances, lighting
- Inrush current limiting circuits
- Overvoltage crowbar protection

Description

Available in through-hole, the T8T series of Triacs can be used as on/off or phase angle control function in general purpose ac switching where high commutation capability is required.

This series can be designed in many value sensitive appliances thanks to the parameters guidance provided in the following pages.

Provides insulation rated at 2500 V rms (TO-220AB insulated package).

TM: Snubberless is a trademark of STMicroelectronics

1 Characteristics

Table 2. Absolute ratings (limiting values; $T_j = 25\text{ °C}$, unless otherwise specified)

Symbol	Parameter			Value	Unit
$I_{T(RMS)}$	On-state rms current (full sine wave)		$T_c = 97\text{ °C}$	8	A
I_{TSM}	Non repetitive surge peak on-state current (full cycle, T_j initial = 25 °C)	F = 50 Hz	$t_p = 20\text{ ms}$	60	A
		F = 60 Hz	$t_p = 16.7\text{ ms}$	63	
I^2t	I^2t Value for fusing		$t_p = 10\text{ ms}$	26	A^2s
di/dt	Critical rate of rise of on-state current $I_G = 2 \times I_{GT}$ $t_r \leq 100\text{ ns}$	F = 60 Hz	$T_j = 125\text{ °C}$	50	A/ μs
V_{DSM} , V_{RSM}	Non repetitive surge peak off-state voltage	$t_p = 10\text{ ms}$	$T_j = 25\text{ °C}$	V_{DRM} , V_{RRM} + 100	V
I_{GM}	Peak gate current	$t_p = 20\text{ }\mu s$	$T_j = 125\text{ °C}$	4	A
$P_{G(AV)}$	Average gate power dissipation		$T_j = 125\text{ °C}$	1	W
T_{stg}	Storage junction temperature range			- 40 to + 150	$^{\circ}C$
T_j	Operating junction temperature range			- 40 to + 125	$^{\circ}C$

Table 3. Electrical characteristics ($T_j = 25\text{ °C}$, unless otherwise specified)

Symbol	Test conditions	Quadrant		T8xxT				Unit
				T810T	T820T	T825T	T835T	
$I_{GT}^{(1)}$	$V_D = 12\text{ V}$, $R_L = 30\ \Omega$	I - II - III	MAX.	10	20	25	35	mA
		IV				40		
V_{GT}	$V_D = V_{DRM}$, $R_L = 30\ \Omega$, $T_j = 25\text{ °C}$	ALL	MAX.	1.3				V
V_{GD}	$V_D = V_{DRM}$, $R_L = 3.3\text{ k}\Omega$, $T_j = 125\text{ °C}$	ALL	MIN.	0.2				V
$I_H^{(2)}$	$I_T = 500\text{ mA}$		MAX.	15	25	30	40	mA
I_L	$I_G = 1.2 I_{GT}$	I - III	MAX.	20	35	40	50	mA
		IV				40		
		II		25	40	70	70	
$dV/dt^{(2)}$	$V_D = 67\% V_{DRM}$, gate open	$T_j = 125\text{ °C}$	MIN.	100	750	500	2000	V/ μ s
		$T_j = 150\text{ °C}^{(3)}$		50	500	300	1000	
$(dI/dt)^c^{(2)}$	$(dV/dt)^c = 0.1\text{ V}/\mu\text{s}$	$T_j = 125\text{ °C}$	MIN.	5.4				A/ms
				$(dV/dt)^c = 10\text{ V}/\mu\text{s}$	2		4.5	
	Without snubber			3.4		8		
	$(dV/dt)^c = 0.1\text{ V}/\mu\text{s}$	$T_j = 150\text{ °C}^{(3)}$		2.5				
				$(dV/dt)^c = 10\text{ V}/\mu\text{s}$	1		2	
	Without snubber				2		6.5	

1. Minimum I_{GT} is guaranteed at 5% of I_{GT} max.
2. For both polarities of A2 referenced to A1.
3. Derating information for excess temperature above T_j max.

Table 4. Static characteristics

Symbol	Test conditions		Value	Unit
$V_T^{(1)}$	$I_{TM} = 11.3\text{ A}$, $t_p = 380\ \mu\text{s}$	$T_j = 25\text{ °C}$	MAX.	1.60 V
$V_{TO}^{(1)}$	Threshold voltage	$T_j = 125\text{ °C}$	MAX.	0.87 V
$R_D^{(1)}$	Dynamic resistance	$T_j = 125\text{ °C}$	MAX.	60 m Ω
I_{DRM} , I_{RRM}	$V_{DRM} = V_{RRM}$	$T_j = 25\text{ °C}$	MAX.	5 μ A
		$T_j = 125\text{ °C}$		1 mA
	$V_D = 0.9 \times V_{DRM}$	$T_j = 150\text{ °C}^{(2)}$	TYP.	1.9

1. For both polarities of A2 referenced to A1.
2. Derating information for excess temperature above T_j max.

Table 5. Thermal resistance

Symbol	Parameter	Value	Unit
$R_{th(j-c)}$	Junction to case (AC)	2.8	$^{\circ}\text{C}/\text{W}$
$R_{th(j-a)}$	Junction to ambient (DC)	60	$^{\circ}\text{C}/\text{W}$

Figure 1. Maximum power dissipation versus rms on-state current

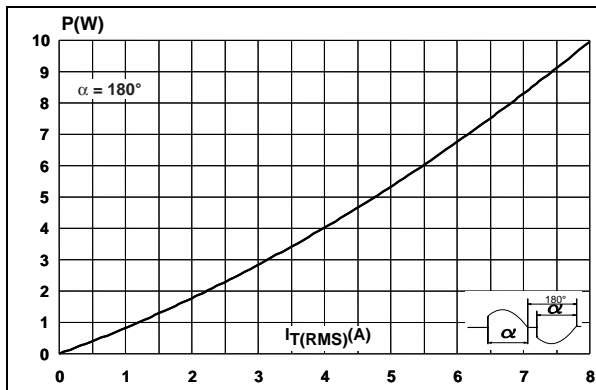

Figure 2. On-state rms current versus case temperature

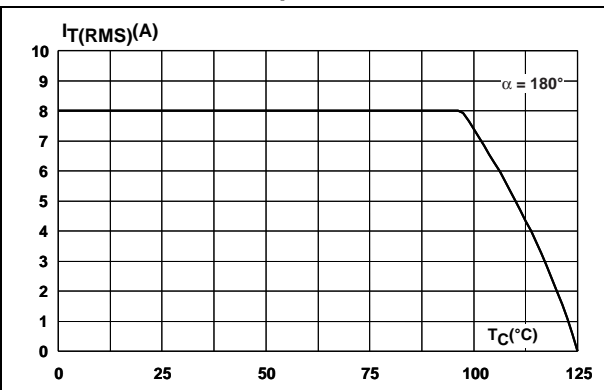

Figure 3. On-state rms current versus ambient temperature (free air convection)

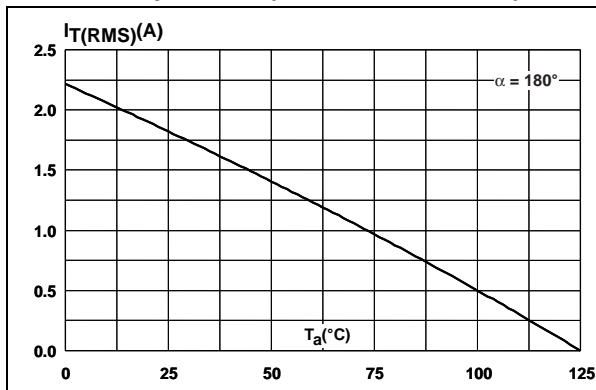

Figure 4. Relative variation of thermal impedance versus pulse duration

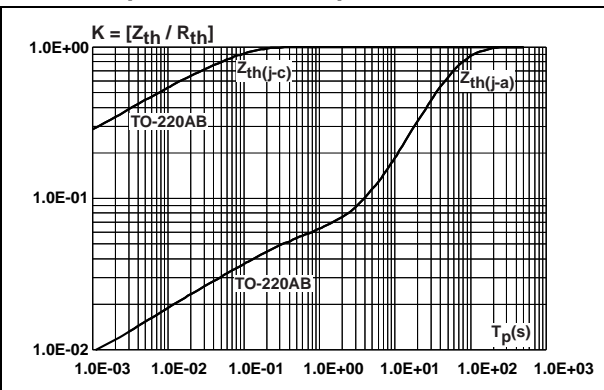

Figure 5. On-state characteristics (maximum values)

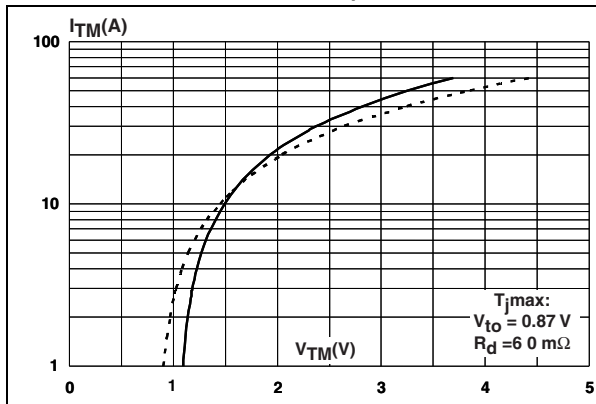

Figure 6. Surge peak on state current versus number of cycles

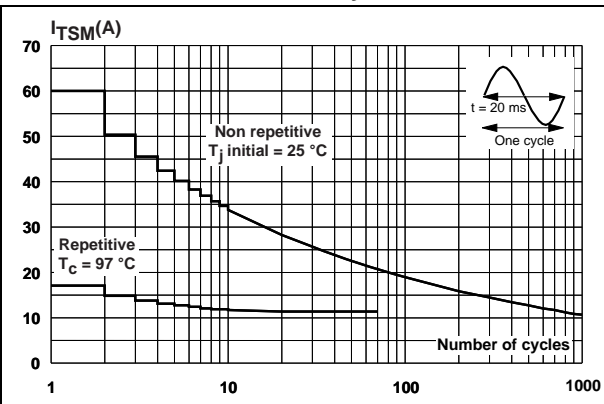

Figure 7. Non repetitive surge peak on-state current for a sinusoidal

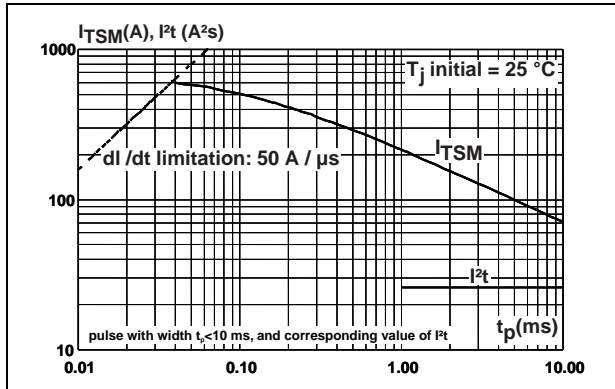

Figure 8. Relative variation of gate trigger current and gate trigger voltage versus junction temperature

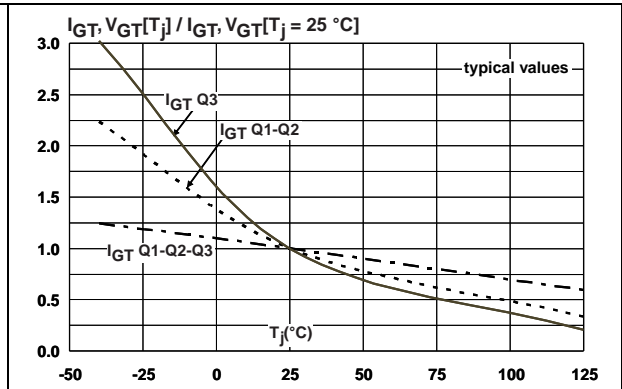

Figure 9. Relative variation of holding current and latching current versus junction temperature

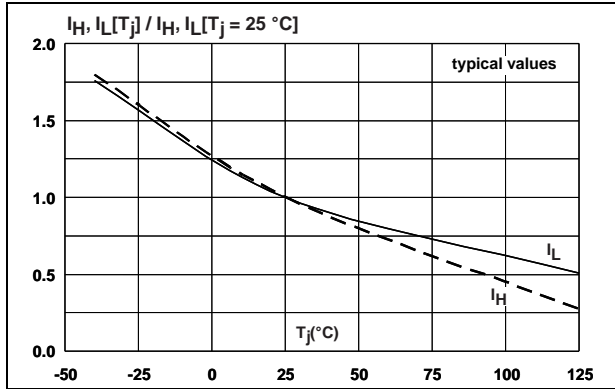

Figure 10. Relative variation of static dV/dt immunity versus junction temperature

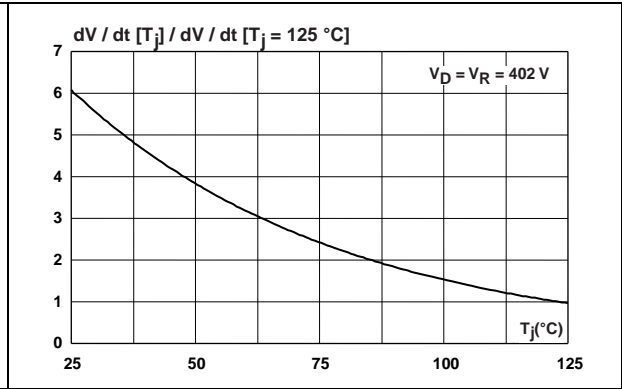

Figure 11. Relative variation of critical rate of decrease of main current versus junction temperature

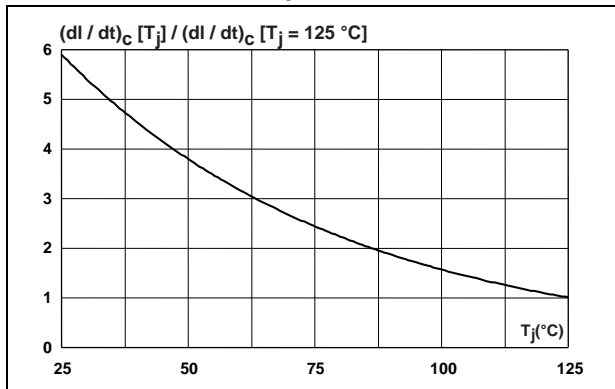
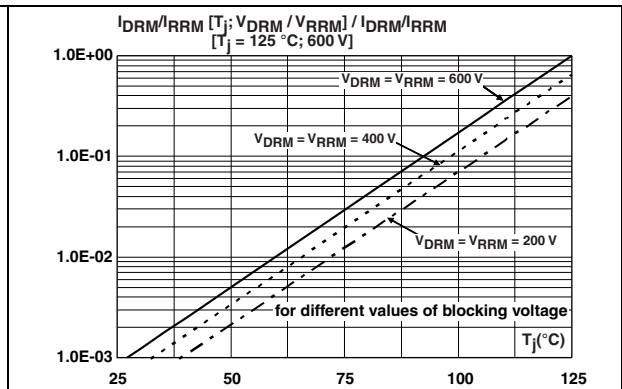

Figure 12. Relative variation of leakage current versus junction temperature



2 Package information

- Epoxy meets UL94, V0
- Lead-free packages

In order to meet environmental requirements, ST offers these devices in different grades of ECOPACK® packages, depending on their level of environmental compliance. ECOPACK® specifications, grade definitions and product status are available at: www.st.com. ECOPACK® is an ST trademark.

Table 6. TO-220AB Insulated dimensions

Ref.	Dimensions					
	Millimeters			Inches		
	Min.	Typ.	Max.	Min.	Typ.	Max.
A	15.20		15.90	0.598		0.625
a1		3.75			0.147	
a2	13.00		14.00	0.511		0.551
B	10.00		10.40	0.393		0.409
b1	0.61		0.88	0.024		0.034
b2	1.23		1.32	0.048		0.051
C	4.40		4.60	0.173		0.181
c1	0.49		0.70	0.019		0.027
c2	2.40		2.72	0.094		0.107
e	2.40		2.70	0.094		0.106
F	6.20		6.60	0.244		0.259
ØI	3.75		3.85	0.147		0.151
I4	15.80	16.40	16.80	0.622	0.646	0.661
L	2.65		2.95	0.104		0.116
I2	1.14		1.70	0.044		0.066
I3	1.14		1.70	0.044		0.066
M		2.60			0.102	

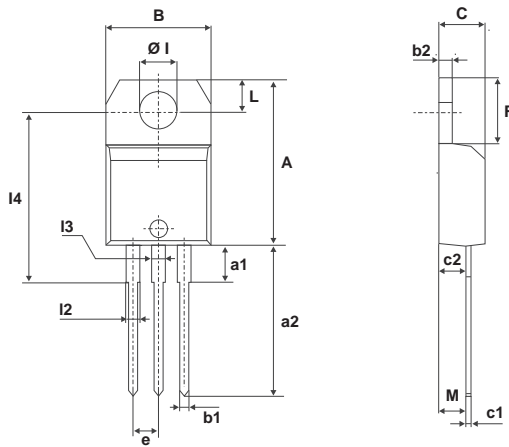

3 Ordering information

Figure 13. Ordering information scheme

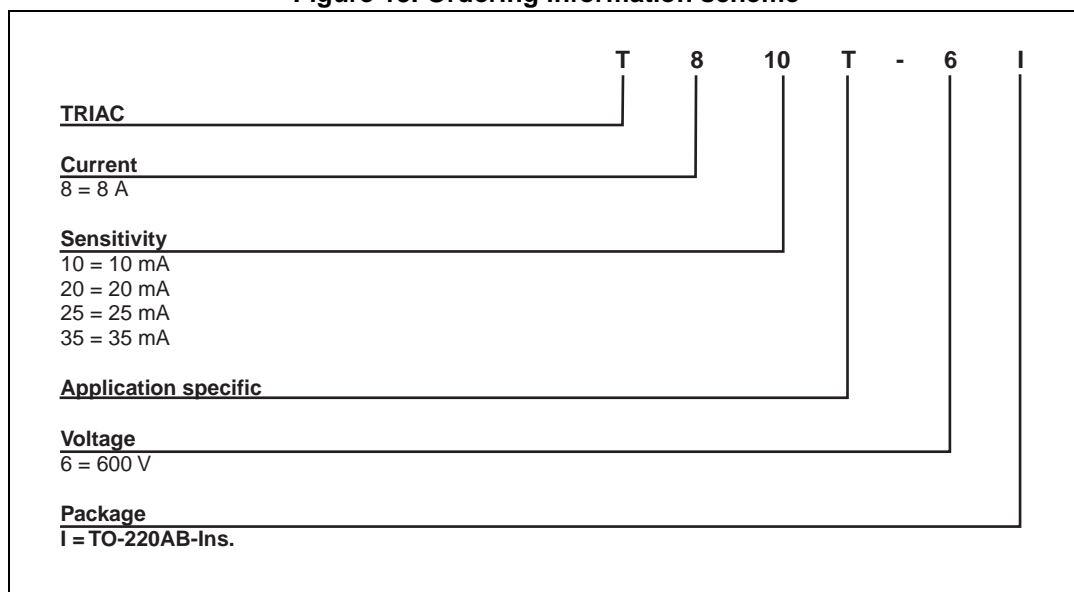

Table 7. Ordering information

Order code	Marking	Package	Weight	Base qty	Delivery mode
T810T-6I	T810T-6I	TO-220AB-Ins.	2.3 g	50	Tube
T820T-6I	T820T-6I				
T825T-6I	T825T-6I				
T835T-6I	T835T-6I				

4 Revision history

Table 8. Document revision history

Date	Revision	Changes
10-Sep-2009	1	First issue.
18-Jan-2010	2	Updated pag.1.
20-Sep-2011	3	Updated: Features . Replaced order codes with part numbers in Table 1 .
16-Sep-2013	4	Replaced order codes with part numbers in Table 1 .

Please Read Carefully:

Information in this document is provided solely in connection with ST products. STMicroelectronics NV and its subsidiaries ("ST") reserve the right to make changes, corrections, modifications or improvements, to this document, and the products and services described herein at any time, without notice.

All ST products are sold pursuant to ST's terms and conditions of sale.

Purchasers are solely responsible for the choice, selection and use of the ST products and services described herein, and ST assumes no liability whatsoever relating to the choice, selection or use of the ST products and services described herein.

No license, express or implied, by estoppel or otherwise, to any intellectual property rights is granted under this document. If any part of this document refers to any third party products or services it shall not be deemed a license grant by ST for the use of such third party products or services, or any intellectual property contained therein or considered as a warranty covering the use in any manner whatsoever of such third party products or services or any intellectual property contained therein.

UNLESS OTHERWISE SET FORTH IN ST'S TERMS AND CONDITIONS OF SALE ST DISCLAIMS ANY EXPRESS OR IMPLIED WARRANTY WITH RESPECT TO THE USE AND/OR SALE OF ST PRODUCTS INCLUDING WITHOUT LIMITATION IMPLIED WARRANTIES OF MERCHANTABILITY, FITNESS FOR A PARTICULAR PURPOSE (AND THEIR EQUIVALENTS UNDER THE LAWS OF ANY JURISDICTION), OR INFRINGEMENT OF ANY PATENT, COPYRIGHT OR OTHER INTELLECTUAL PROPERTY RIGHT.

ST PRODUCTS ARE NOT DESIGNED OR AUTHORIZED FOR USE IN: (A) SAFETY CRITICAL APPLICATIONS SUCH AS LIFE SUPPORTING, ACTIVE IMPLANTED DEVICES OR SYSTEMS WITH PRODUCT FUNCTIONAL SAFETY REQUIREMENTS; (B) AERONAUTIC APPLICATIONS; (C) AUTOMOTIVE APPLICATIONS OR ENVIRONMENTS, AND/OR (D) AEROSPACE APPLICATIONS OR ENVIRONMENTS. WHERE ST PRODUCTS ARE NOT DESIGNED FOR SUCH USE, THE PURCHASER SHALL USE PRODUCTS AT PURCHASER'S SOLE RISK, EVEN IF ST HAS BEEN INFORMED IN WRITING OF SUCH USAGE, UNLESS A PRODUCT IS EXPRESSLY DESIGNATED BY ST AS BEING INTENDED FOR "AUTOMOTIVE, AUTOMOTIVE SAFETY OR MEDICAL" INDUSTRY DOMAINS ACCORDING TO ST PRODUCT DESIGN SPECIFICATIONS. PRODUCTS FORMALLY ESCC, QML OR JAN QUALIFIED ARE DEEMED SUITABLE FOR USE IN AEROSPACE BY THE CORRESPONDING GOVERNMENTAL AGENCY.

Resale of ST products with provisions different from the statements and/or technical features set forth in this document shall immediately void any warranty granted by ST for the ST product or service described herein and shall not create or extend in any manner whatsoever, any liability of ST.

ST and the ST logo are trademarks or registered trademarks of ST in various countries.

Information in this document supersedes and replaces all information previously supplied.

The ST logo is a registered trademark of STMicroelectronics. All other names are the property of their respective owners.

© 2013 STMicroelectronics - All rights reserved

STMicroelectronics group of companies

Australia - Belgium - Brazil - Canada - China - Czech Republic - Finland - France - Germany - Hong Kong - India - Israel - Italy - Japan - Malaysia - Malta - Morocco - Philippines - Singapore - Spain - Sweden - Switzerland - United Kingdom - United States of America

www.st.com