

1 2 3 4 5 6

A

B

C

D

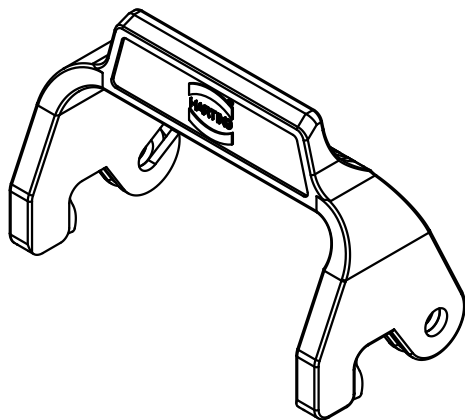
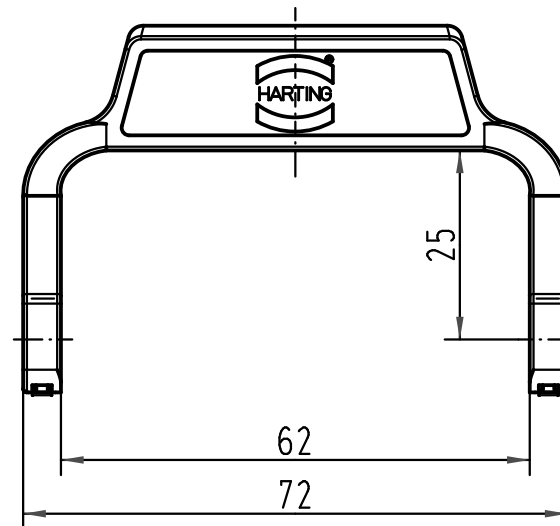
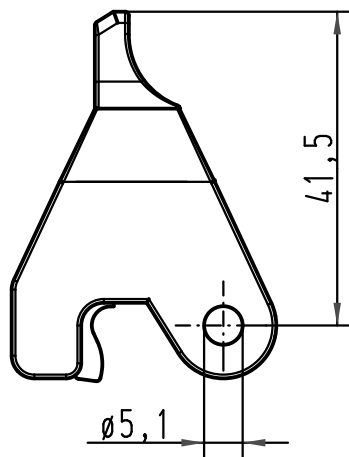

All Dimensions in mm Original Size DIN A 4		Techn. Character.			Nicht tolerierte Maße/Free size tolerances		
			Dat.	Name	Maßstab/Scale 1:1	Han-Easy-Lock 6B Längsbügel/single lever	
			Detail.	27.07.10			Rull
			Insp.				Sch
			Stand.				
A			HARTING Electric GmbH & Co. KG			TB 09 00 000 5222 Sub. TB 09 00 000 5222 v. 13.07.00	
Mod.	Dat.	Name	D-32339 Espelkamp				
						Blatt/page	

