

EL7457

40MHz Non-Inverting Quad CMOS Driver

FN7288  
Rev 4.00  
January 26, 2012

The EL7457 is a high speed, non-inverting, quad CMOS driver. It is capable of running at clock rates up to 40MHz and features 2A peak drive capability and a nominal on-resistance of just 3Ω. The EL7457 is ideal for driving highly capacitive loads, such as storage and vertical clocks in CCD applications. It is also well suited to ATE pin driving, level-shifting, and clock-driving applications.

The EL7457 is capable of running from single or dual power supplies while using ground referenced inputs. Each output can be switched to either the high (V<sub>H</sub>) or low (V<sub>L</sub>) supply pins, depending on the related input pin. The inputs are compatible with both 3V and 5V CMOS and TTL logic. The output enable (OE) pin can be used to put the outputs into a high-impedance state. This is especially useful in CCD applications, where the driver should be disabled during power down.

The EL7457 also features very fast rise and fall times which are matched to within 1ns. The propagation delay is also matched between rising and falling edges to within 2ns.

The EL7457 is available in 16-pin QSOP, 16-pin SO (0.150"), and 16-pin QFN packages. All are specified for operation over the full -40°C to +85°C temperature range.

Pinouts

EL7457  
[16-PIN SO (0.150"),  
QSOP (0.150")]  
TOP VIEW

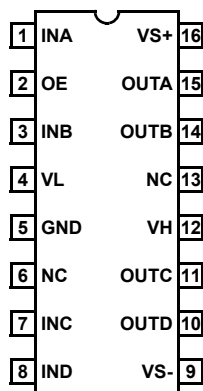

EL7457  
[16-PIN QFN (4X4MM)]  
TOP VIEW

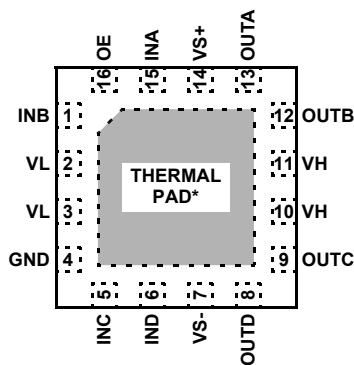

\* THERMAL PAD CONNECTED TO PIN 7 (V<sub>S-</sub>)

Features

- Clocking speeds up to 40MHz
- 4 channels
- 12ns t<sub>R</sub>/t<sub>F</sub> at 1000pF C<sub>LOAD</sub>
- 1ns rise and fall time match
- 1.5ns prop delay match
- Low quiescent current - <1mA
- Fast output enable function - 12ns
- Wide output voltage range
- 8V ≥ V<sub>L</sub> ≥ -5V
- -2V ≤ V<sub>H</sub> ≤ 16.5V
- 2A peak drive
- 3Ω on resistance
- Input level shifters
- TTL/CMOS input-compatible
- Pb-free (RoHS compliant)

Applications

- CCD drivers
- Digital cameras
- Pin drivers
- Clock/line drivers
- Ultrasound transducer drivers
- Ultrasonic and RF generators
- Level shifting

## Ordering Information

PART NUMBER (Notes 2, 3)	PART MARKING	TEMP. RANGE (°C)	PACKAGE (Pb-free)	PKG. DWG. #
EL7457CUZ	7457CUZ	-40°C to +85°C	16 Ld QSOP (0.150")	MDP0040
EL7457CUZ-T13 (Note 1)	7457CUZ	-40°C to +85°C	16 Ld QSOP (0.150")	MDP0040
EL7457CUZ-T7 (Note 1)	7457CUZ	-40°C to +85°C	16 Ld QSOP (0.150")	MDP0040
EL7457CUZ-T7A (Note 1)	7457CUZ	-40°C to +85°C	16 Ld QSOP (0.150")	MDP0040
EL7457CSZ	EL7457CSZ	-40°C to +85°C	16 Ld SO (0.150")	MDP0027
EL7457CSZ-T13 (Note 1)	EL7457CSZ	-40°C to +85°C	16 Ld SO (0.150")	MDP0027
EL7457CSZ-T7 (Note 1)	EL7457CSZ	-40°C to +85°C	16 Ld SO (0.150")	MDP0027
EL7457CSZ-T7A (Note 1)	EL7457CSZ	-40°C to +85°C	16 Ld SO (0.150")	MDP0027
EL7457CLZ	7457CLZ	-40°C to +85°C	16 Ld QFN (4x4mm)	L16.4X4H
EL7457CLZ-T13 (Note 1)	7457CLZ	-40°C to +85°C	16 Ld QFN (4x4mm)	L16.4X4H
EL7457CLZ-T7 (Note 1)	7457CLZ	-40°C to +85°C	16 Ld QFN (4x4mm)	L16.4X4H
EL7457CLZ-T7A (Note 1)	7457CLZ	-40°C to +85°C	16 Ld QFN (4x4mm)	L16.4X4H

### NOTES:

1. Please refer to [TB347](#) for details on reel specifications.
2. These Intersil Pb-free plastic packaged products employ special Pb-free material sets, molding compounds/die attach materials, and 100% matte tin plate plus anneal (e3 termination finish, which is RoHS compliant and compatible with both SnPb and Pb-free soldering operations). Intersil Pb-free products are MSL classified at Pb-free peak reflow temperatures that meet or exceed the Pb-free requirements of IPC/JEDEC J STD-020.
3. For Moisture Sensitivity Level (MSL), please see device information page for [EL7457](#). For more information on MSL please see tech brief [TB363](#).

**Absolute Maximum Ratings** ( $T_A = 25^\circ\text{C}$ )

Supply Voltage ( $V_{S+}$ to $V_{S-}$ )	+18V
Input Voltage	$V_{S-} - 0.3\text{V}$ , $V_{S+} + 0.3\text{V}$
Continuous Output Current	100mA
Storage Temperature Range	$-65^\circ\text{C}$ to $+150^\circ\text{C}$

**Thermal Information**

Thermal Resistance	$\theta_{JA}$ ( $^\circ\text{C}/\text{W}$ )	$\theta_{JC}$ ( $^\circ\text{C}/\text{W}$ )
16 Ld QFN (Notes 4, 5)	43	5
16 Ld SOIC (Notes 6, 7)	73	45
16 Ld QSOP (Note 6)	112	N/A
Ambient Operating Temperature	$-40^\circ\text{C}$ to $+85^\circ\text{C}$	
Maximum Die Temperature	$+125^\circ\text{C}$	
Power Dissipation	See Curves	
Pb-Free Reflow Profile	see link below	
	<a href="http://www.intersil.com/pbfree/Pb-FreeReflow.asp">http://www.intersil.com/pbfree/Pb-FreeReflow.asp</a>	

**CAUTION:** Do not operate at or near the maximum ratings listed for extended periods of time. Exposure to such conditions may adversely impact product reliability and result in failures not covered by warranty.

**NOTES:**

- $\theta_{JA}$  is measured in free air with the component mounted on a high effective thermal conductivity test board with "direct attach" features. See Tech Brief [TB379](#).
- For  $\theta_{JC}$ , the "case temp" location is the center of the exposed metal pad on the package underside.
- $\theta_{JA}$  is measured with the component mounted on a high effective thermal conductivity test board in free air. See Tech Brief [TB379](#) for details.
- For  $\theta_{JC}$ , the "case temp" location is taken at the package top center.

**IMPORTANT NOTE:** All parameters having Min/Max specifications are guaranteed. Typical values are for information purposes only. Unless otherwise noted, all tests are at the specified temperature and are pulsed tests, therefore:  $T_J = T_C = T_A$

**Electrical Specifications**  $V_{S+} = +5\text{V}$ ,  $V_{S-} = -5\text{V}$ ,  $V_H = +5\text{V}$ ,  $V_L = -5\text{V}$ ,  $T_A = 25^\circ\text{C}$ , unless otherwise specified.

PARAMETER	DESCRIPTION	CONDITION	MIN (Note 8)	TYP	MAX (Note 8)	UNIT
<b>INPUT</b>						
$V_{IH}$	Logic "1" Input Voltage		2.0			V
$I_{IH}$	Logic "1" Input Current	$V_{IH} = 5\text{V}$		0.1	10	$\mu\text{A}$
$V_{IL}$	Logic "0" Input Voltage				0.8	V
$I_{IL}$	Logic "0" Input Current	$V_{IL} = 0\text{V}$		0.1	10	$\mu\text{A}$
$C_{IN}$	Input Capacitance			3.5		pF
$R_{IN}$	Input Resistance			50		M $\Omega$
<b>OUTPUT</b>						
$R_{OH}$	ON Resistance $V_H$ to OUTx	$I_{OUT} = -100\text{mA}$		4.5	6	$\Omega$
$R_{OL}$	ON Resistance $V_L$ to OUTx	$I_{OUT} = +100\text{mA}$		4	6	$\Omega$
$I_{LEAK}$	Output Leakage Current	$V_H = V_{S+}$ , $V_L = V_{S-}$		0.1	10	$\mu\text{A}$
$I_{PK}$	Peak Output Current	Source		2.0		A
		Sink		2.0		A
<b>POWER SUPPLY</b>						
$I_S$	Power Supply Current	Inputs = $V_{S+}$		0.5	1.5	mA
<b>SWITCHING CHARACTERISTICS</b>						
$t_R$	Rise Time	$C_L = 1000\text{pF}$		13.5		ns
$t_F$	Fall Time	$C_L = 1000\text{pF}$		13		ns
$t_{RFA}$	$t_R$ , $t_F$ Mismatch	$C_L = 1000\text{pF}$		0.5		ns
$t_{D+}$	Turn-Off Delay Time	$C_L = 1000\text{pF}$		12.5		ns
$t_{D-}$	Turn-On Delay Time	$C_L = 1000\text{pF}$		14.5		ns
$t_{DD}$	$t_{D-1} - t_{D-2}$ Mismatch	$C_L = 1000\text{pF}$		2		ns
$t_{ENABLE}$	Enable Delay Time			12		ns

**Electrical Specifications**  $V_{S+} = +5V, V_{S-} = -5V, V_H = +5V, V_L = -5V, T_A = 25^\circ C$ , unless otherwise specified.

PARAMETER	DESCRIPTION	CONDITION	MIN (Note 8)	TYP	MAX (Note 8)	UNIT
$t_{DISABLE}$	Disable Delay Time			12		ns

**Electrical Specifications**  $V_{S+} = +15V, V_{S-} = 0V, V_H = +15V, V_L = 0V, T_A = 25^\circ C$ , unless otherwise specified

PARAMETER	DESCRIPTION	CONDITION	MIN (Note 8)	TYP	MAX (Note 8)	UNIT
<b>INPUT</b>						
$V_{IH}$	Logic "1" Input Voltage		2.4			V
$I_{IH}$	Logic "1" Input Current	$V_{IH} = 5V$		0.1	10	$\mu A$
$V_{IL}$	Logic "0" Input Voltage				0.8	V
$I_{IL}$	Logic "0" Input Current	$V_{IL} = 0V$		0.1	10	$\mu A$
$C_{IN}$	Input Capacitance			3.5		pF
$R_{IN}$	Input Resistance			50		$M\Omega$
<b>OUTPUT</b>						
$R_{OH}$	ON Resistance $V_H$ to OUT	$I_{OUT} = -100mA$		3.5	5	$\Omega$
$R_{OL}$	ON Resistance $V_L$ to OUT	$I_{OUT} = +100mA$		3	5	$\Omega$
$I_{LEAK}$	Output Leakage Current	$V_H = V_{S+}, V_L = V_{S-}$		0.1	10	$\mu A$
$I_{PK}$	Peak Output Current	Source		2.0		A
		Sink		2.0		A
<b>POWER SUPPLY</b>						
$I_S$	Power Supply Current	Inputs = $V_{S+}$		0.8	2	mA
<b>SWITCHING CHARACTERISTICS</b>						
$t_R$	Rise Time	$C_L = 1000pF$		11		ns
$t_F$	Fall Time	$C_L = 1000pF$		12		ns
$t_{RF\Delta}$	$t_R, t_F$ Mismatch	$C_L = 1000pF$		1		ns
$t_{D+}$	Turn-Off Delay Time	$C_L = 1000pF$		11.5		ns
$t_{D-}$	Turn-On Delay Time	$C_L = 1000pF$		13		ns
$t_{DD}$	$t_{D-1} - t_{D-2}$ Mismatch	$C_L = 1000pF$		1.5		ns
$t_{ENABLE}$	Enable Delay Time			12		ns
$t_{DISABLE}$	Disable Delay Time			12		ns

## NOTE:

8. Compliance to datasheet limits is assured by one or more methods: production test, characterization and/or design.

### Typical Performance Curves

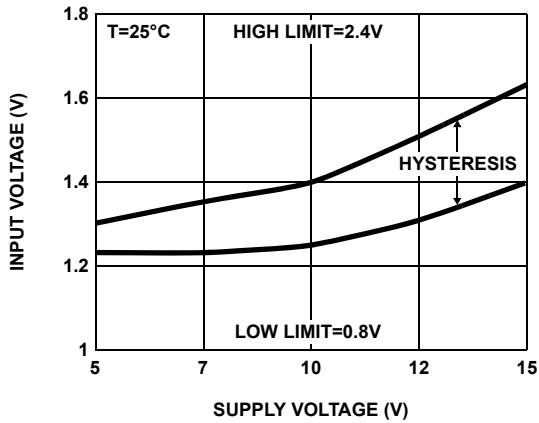

FIGURE 1. SWITCH THRESHOLD vs SUPPLY VOLTAGE

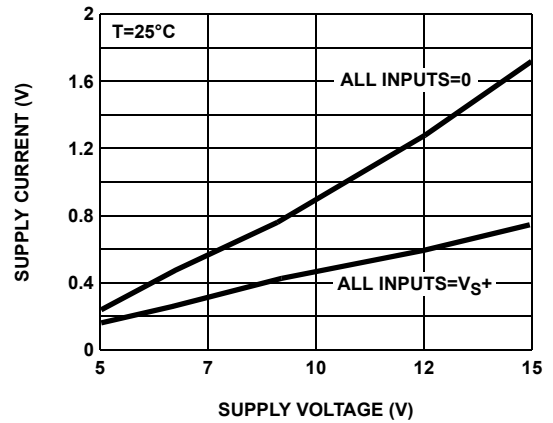

FIGURE 2. QUIESCENT SUPPLY CURRENT vs SUPPLY VOLTAGE

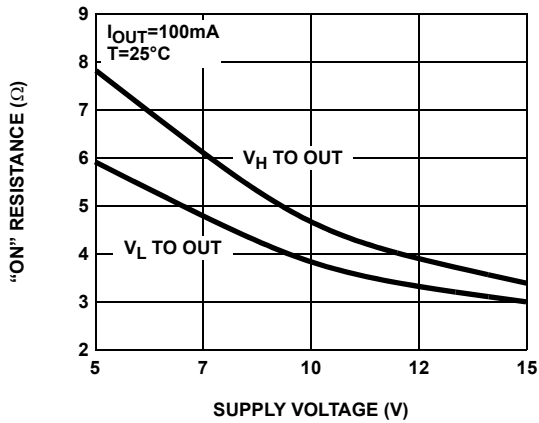

FIGURE 3. "ON" RESISTANCE vs SUPPLY VOLTAGE

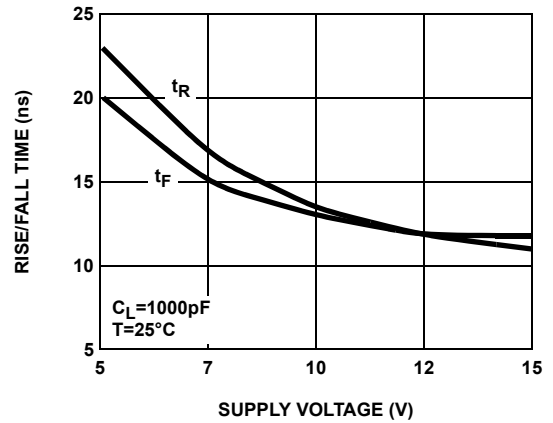

FIGURE 4. RISE/FALL TIME vs SUPPLY VOLTAGE

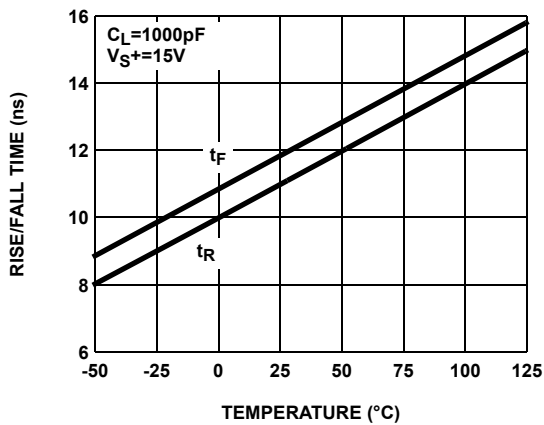

FIGURE 5. RISE/FALL TIME vs TEMPERATURE

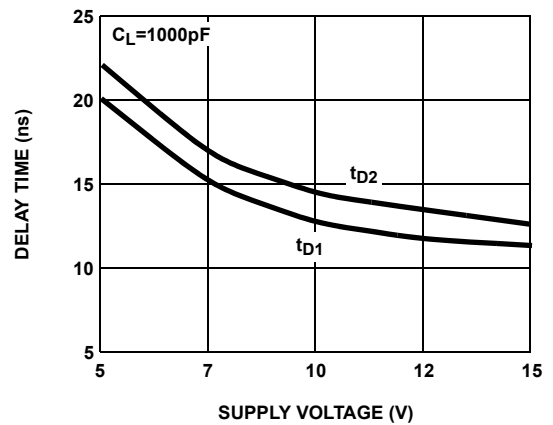

FIGURE 6. PROPAGATION DELAY vs SUPPLY VOLTAGE

**Typical Performance Curves** (Continued)

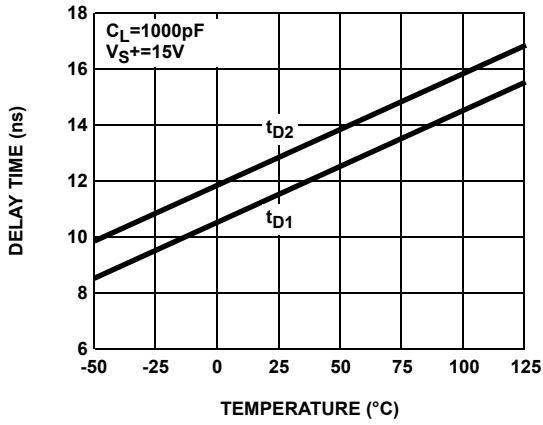

FIGURE 7. PROPAGATION DELAY vs TEMPERATURE

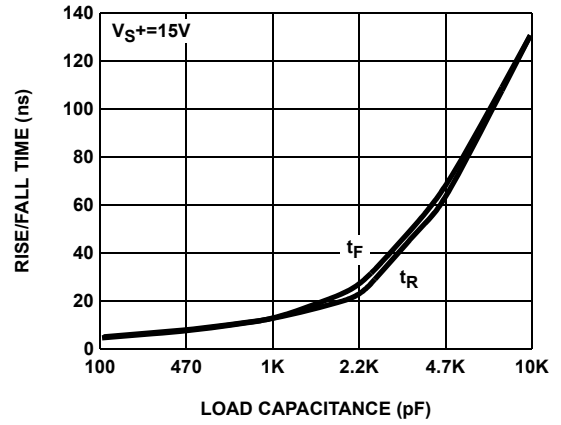

FIGURE 8. RISE/FALL TIME vs LOAD

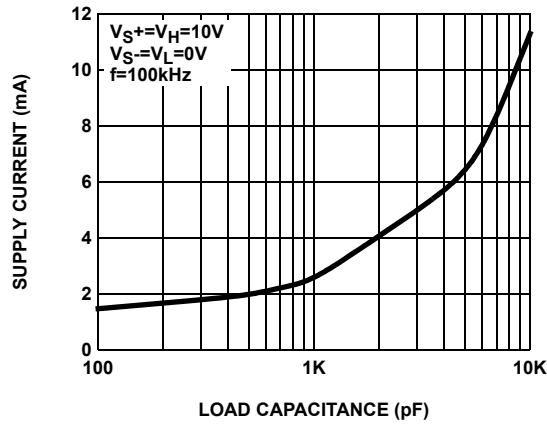
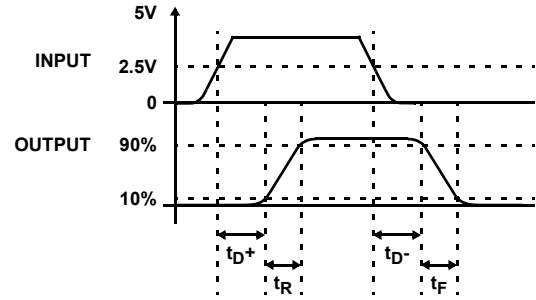

FIGURE 9. SUPPLY CURRENT PER CHANNEL vs CAPACITIVE LOAD

TABLE 1. NOMINAL OPERATING VOLTAGE RANGE

PIN	MIN	MAX
$V_{S+}$ to $V_{S-}$	5V	16.5V
$V_{S-}$ to GND	-5V	0V
$V_H$	$V_{S-} + 2.5V$	$V_{S+}$
$V_L$	$V_{S-}$	$V_{S+}$
$V_H$ to $V_L$	0V	16.5V
$V_L$ to $V_{S-}$	0V	8V

Timing Diagram



Standard Test Configuration (CS/CU)

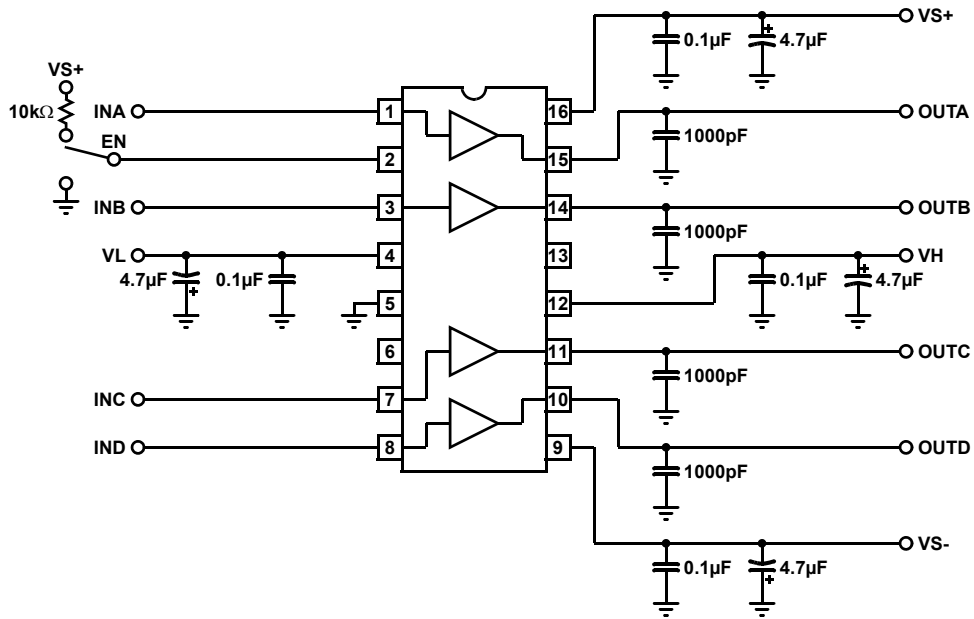

**Pin Descriptions**

16-PIN QSOP (0.150"), SO (0.150")	16-PIN QFN (4x4mm)	NAME	FUNCTION	EQUIVALENT CIRCUIT
1	15	INA	Input channel A	<p>CIRCUIT 1</p>
2	16	OE	Output Enable	(Reference Circuit 1)
3	1	INB	Input channel B	(Reference Circuit 1)
4	2, 3	VL	Low voltage input pin	
5	4	GND	Input logic ground	
6, 13		NC	No connection	
7	5	INC	Input channel C	(Reference Circuit 1)
8	6	IND	Input channel D	(Reference Circuit 1)
9	7	VS-	Negative supply voltage	
10	8	OUTD	Output channel D	<p>CIRCUIT 2</p>
11	9	OUTC	Output channel C	(Reference Circuit 2)
12	10, 11	VH	High voltage input pin	
14	12	OUTB	Output channel B	(Reference Circuit 2)
15	13	OUTA	Output channel A	(Reference Circuit 2)
16	14	VS+	Positive supply voltage	



## Block Diagram

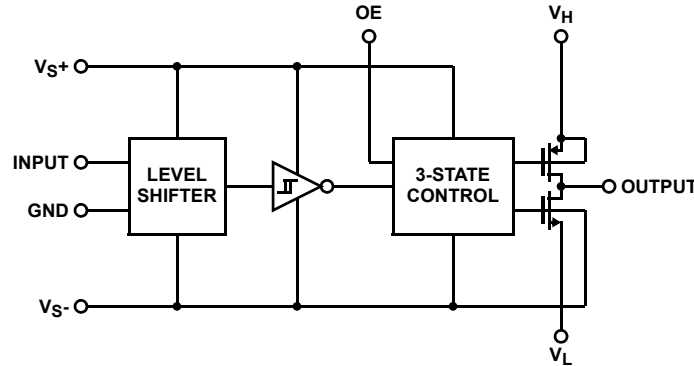

## Applications Information

### Product Description

The EL7457 is a high performance 40MHz high speed quad driver. Each channel of the EL7457 consists of a single P-channel high side driver and a single N-channel low side driver. These 3Ω devices will pull the output (OUT<sub>X</sub>) to either the high or low voltage, on V<sub>H</sub> and V<sub>L</sub> respectively, depending on the input logic signal (IN<sub>X</sub>). It should be noted that there is only one set of high and low voltage pins.

A common output enable (OE) pin is available on the EL7457. This pin, when pulled low will put all outputs in to the high impedance state.

The EL7457 is available in 16-pin SO (0.150"), 16-pin QSOP, and ultra-small 16-pin QFN packages. The relevant package should be chosen depending on the calculated power dissipation.

### Supply Voltage Range and Input Compatibility

The EL7457 is designed for operation on supplies from 5V to 15V with 10% tolerance (i.e. 4.5V to 18V). The table on page 6 shows the specifications for the relationship between the V<sub>S+</sub>, V<sub>S-</sub>, V<sub>H</sub>, V<sub>L</sub>, and GND pins. The EL7457 does not contain a true analog switch and therefore V<sub>L</sub> should always be less than V<sub>H</sub>.

All input pins are compatible with both 3V and 5V CMOS signals. With a positive supply (V<sub>S+</sub>) of 5V, the EL7457 is also compatible with TTL inputs.

### Power Supply Bypassing

When using the EL7457, it is very important to use adequate power supply bypassing. The high switching currents developed by the EL7457 necessitate the use of a bypass capacitor on both the positive and negative supplies. It is recommended that a 4.7μF tantalum capacitor be used in parallel with a 0.1μF low-inductance ceramic MLC capacitor. These should be placed as close to the supply pins as possible. It is also recommended that the V<sub>H</sub> and V<sub>L</sub> pins have some level of bypassing, especially if the EL7457 is driving highly capacitive loads.

### Power Dissipation Calculation

When switching at high speeds, or driving heavy loads, the EL7457 drive capability is limited by the rise in die temperature brought about by internal power dissipation. For reliable operation die temperature must be kept below T<sub>JMAX</sub> (125°C). It is necessary to calculate the power dissipation for a given application prior to selecting package type.

Power dissipation may be calculated:

$$PD = (V_S \times I_S) + \sum_1^4 (C_{INT} \times V_S^2 \times f) + (C_L \times V_{OUT}^2 \times f) \quad (\text{EQ. 1})$$

where:

V<sub>S</sub> is the total power supply to the EL7457 (from V<sub>S+</sub> to V<sub>S-</sub>)

V<sub>OUT</sub> is the swing on the output (V<sub>H</sub> - V<sub>L</sub>)

C<sub>L</sub> is the load capacitance

C<sub>INT</sub> is the internal load capacitance (80pF max)

I<sub>S</sub> is the quiescent supply current (3mA max)

f is frequency

Having obtained the application's power dissipation, the maximum junction temperature can be calculated:

$$T_{JMAX} = T_{MAX} + \theta_{JA} \times PD \quad (\text{EQ. 2})$$

where:

T<sub>JMAX</sub> is the maximum junction temperature (125°C)

T<sub>MAX</sub> is the maximum ambient operating temperature

PD is the power dissipation calculated above

θ<sub>JA</sub> is the thermal resistance, junction to ambient, of the application (package + PCB combination). Refer to the Package Power Dissipation curves on page 6.

**Quarter Size Outline Plastic Packages Family (QSOP)**



**MDP0040**

**QUARTER SIZE OUTLINE PLASTIC PACKAGES FAMILY**

SYMBOL	INCHES			TOLERANCE	NOTES
	QSOP16	QSOP24	QSOP28		
A	0.068	0.068	0.068	Max.	-
A1	0.006	0.006	0.006	$\pm 0.002$	-
A2	0.056	0.056	0.056	$\pm 0.004$	-
b	0.010	0.010	0.010	$\pm 0.002$	-
c	0.008	0.008	0.008	$\pm 0.001$	-
D	0.193	0.341	0.390	$\pm 0.004$	1, 3
E	0.236	0.236	0.236	$\pm 0.008$	-
E1	0.154	0.154	0.154	$\pm 0.004$	2, 3
e	0.025	0.025	0.025	Basic	-
L	0.025	0.025	0.025	$\pm 0.009$	-
L1	0.041	0.041	0.041	Basic	-
N	16	24	28	Reference	-

Rev. F 2/07

**NOTES:**

1. Plastic or metal protrusions of 0.006" maximum per side are not included.
2. Plastic interlead protrusions of 0.010" maximum per side are not included.
3. Dimensions "D" and "E1" are measured at Datum Plane "H".
4. Dimensioning and tolerancing per ASME Y14.5M-1994.

© Copyright Intersil Americas LLC 2002-2012. All Rights Reserved.  
 All trademarks and registered trademarks are the property of their respective owners.

For additional products, see [www.intersil.com/en/products.html](http://www.intersil.com/en/products.html)

Intersil products are manufactured, assembled and tested utilizing ISO9001 quality systems as noted in the quality certifications found at [www.intersil.com/en/support/qualandreliability.html](http://www.intersil.com/en/support/qualandreliability.html)

Intersil products are sold by description only. Intersil may modify the circuit design and/or specifications of products at any time without notice, provided that such modification does not, in Intersil's sole judgment, affect the form, fit or function of the product. Accordingly, the reader is cautioned to verify that datasheets are current before placing orders. Information furnished by Intersil is believed to be accurate and reliable. However, no responsibility is assumed by Intersil or its subsidiaries for its use; nor for any infringements of patents or other rights of third parties which may result from its use. No license is granted by implication or otherwise under any patent or patent rights of Intersil or its subsidiaries.

For information regarding Intersil Corporation and its products, see [www.intersil.com](http://www.intersil.com)

**Small Outline Package Family (SO)**



**MDP0027**

**SMALL OUTLINE PACKAGE FAMILY (SO)**

SYMBOL	INCHES							TOLERANCE	NOTES
	SO-8	SO-14	SO16 (0.150")	SO16 (0.300") (SOL-16)	SO20 (SOL-20)	SO24 (SOL-24)	SO28 (SOL-28)		
A	0.068	0.068	0.068	0.104	0.104	0.104	0.104	MAX	-
A1	0.006	0.006	0.006	0.007	0.007	0.007	0.007	±0.003	-
A2	0.057	0.057	0.057	0.092	0.092	0.092	0.092	±0.002	-
b	0.017	0.017	0.017	0.017	0.017	0.017	0.017	±0.003	-
c	0.009	0.009	0.009	0.011	0.011	0.011	0.011	±0.001	-
D	0.193	0.341	0.390	0.406	0.504	0.606	0.704	±0.004	1, 3
E	0.236	0.236	0.236	0.406	0.406	0.406	0.406	±0.008	-
E1	0.154	0.154	0.154	0.295	0.295	0.295	0.295	±0.004	2, 3
e	0.050	0.050	0.050	0.050	0.050	0.050	0.050	Basic	-
L	0.025	0.025	0.025	0.030	0.030	0.030	0.030	±0.009	-
L1	0.041	0.041	0.041	0.056	0.056	0.056	0.056	Basic	-
h	0.013	0.013	0.013	0.020	0.020	0.020	0.020	Reference	-
N	8	14	16	16	20	24	28	Reference	-

Rev. M 2/07

**NOTES:**

1. Plastic or metal protrusions of 0.006" maximum per side are not included.
2. Plastic interlead protrusions of 0.010" maximum per side are not included.
3. Dimensions "D" and "E1" are measured at Datum Plane "H".
4. Dimensioning and tolerancing per ASME Y14.5M-1994

# Package Outline Drawing

## L16.4x4H

16 LEAD QUAD FLAT NO-LEAD PLASTIC PACKAGE

Rev 0, 1/12

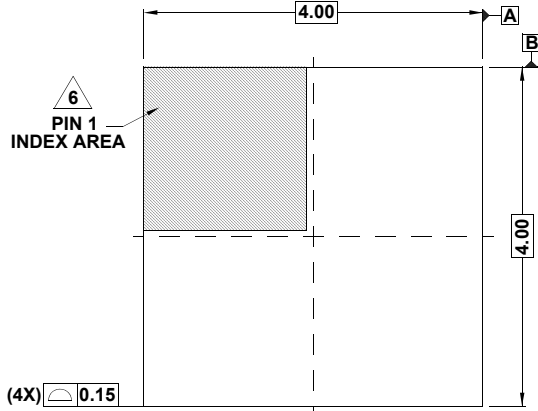

TOP VIEW

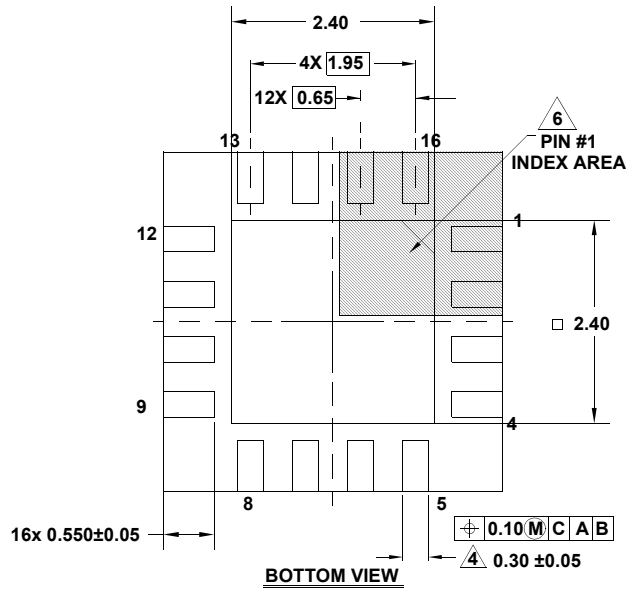

BOTTOM VIEW

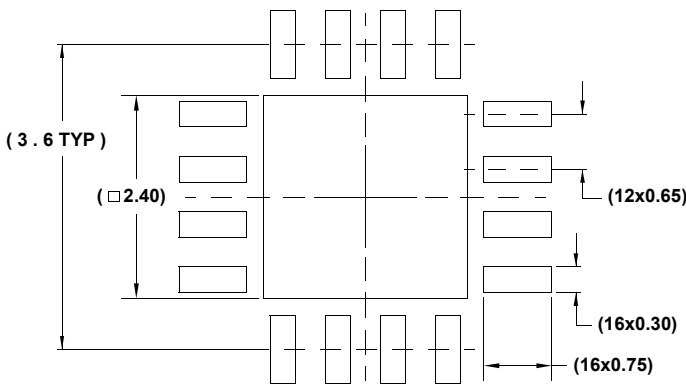

TYPICAL RECOMMENDED LAND PATTERN

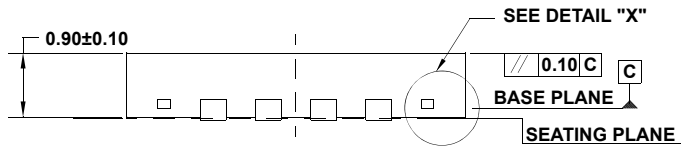

SIDE VIEW

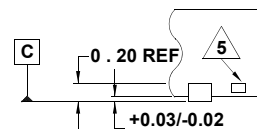

DETAIL "X"

NOTES:

1. Dimensions are in millimeters.  
Dimensions in ( ) for Reference Only.
2. Dimensioning and tolerancing conform to ASME Y14.5m-1994.
3. Unless otherwise specified, tolerance : Decimal ± 0.05
4. Dimension applies to the metallized terminal and is measured between 0.15mm and 0.30mm from the terminal tip.
5. Tiebar shown (if present) is a non-functional feature.
6. The configuration of the pin #1 identifier is optional, but must be located within the zone indicated. The pin #1 identifier may be either a mold or mark feature.