

HDSM-531W/533W

0.56inch (14.0mm)

Single digit surface mount LED display



Data Sheet

Description

This is 0.56" (14.22mm) height single digit display. This device utilizes white ChipLED. This device comes with top surface gray and white segments.

White HDSM-	Description
531W	Common Anode, Right Hand Decimal
533W	Common Cathode, Right Hand Decimal

Features

- 0.56" digit height
- Low current operation
- Excellent characters appearance
- Available in CA and CC
- 1000 pieces per reel
- Moisture Sensitivity Level: Level 3
- RoHS compliant

Package Dimensions

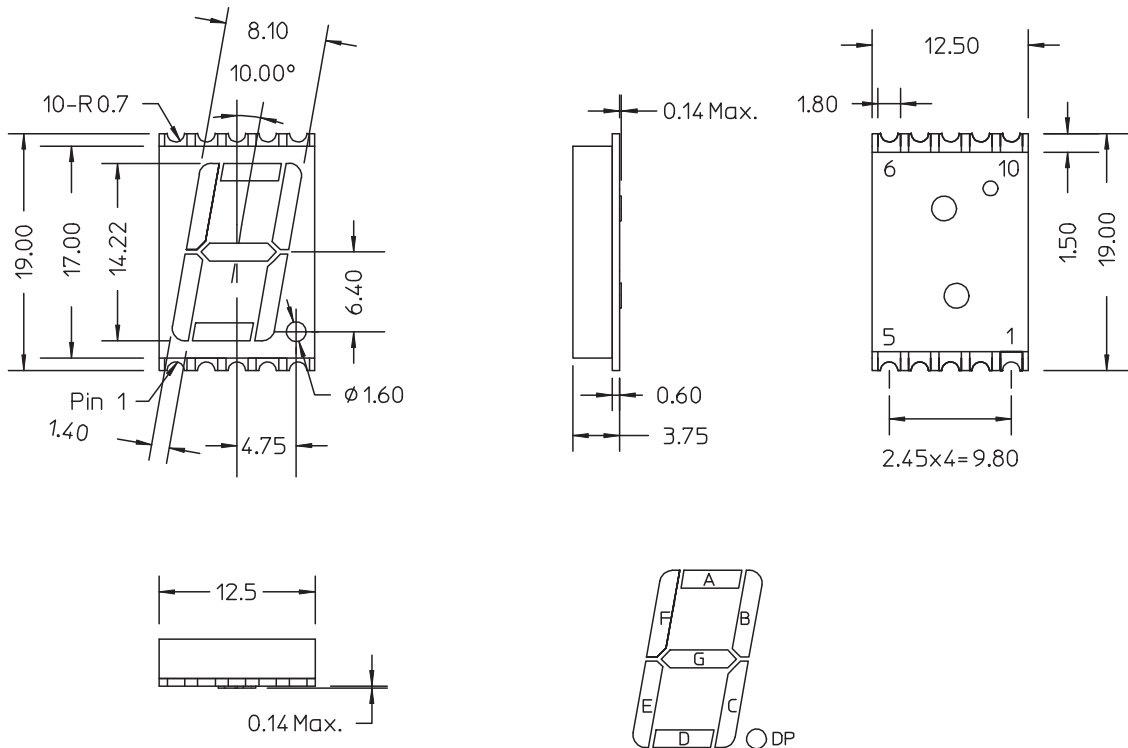

Notes:

All dimensions are in millimeters (inches).
Tolerance: $\pm 0.25\text{mm}$ (0.01") unless otherwise noted.

CAUTION: LEDs are Class 1A ESD sensitive per JESD22-A114C.01.
Please observe appropriate precautions during handling and processing.

Pin Connection (Common Anode)

Pin No.	Connection
1	CATHODE E
2	CATHODE D
3	COMMON ANODE
4	CATHODE C
5	CATHODE DP
6	CATHODE B
7	CATHODE A
8	COMMON ANODE
9	CATHODE F
10	CATHODE G

Pin Connection (Common Cathode)

Pin No.	Connection
1	ANODE E
2	ANODE D
3	COMMON CATHODE
4	ANODE C
5	ANODE DP
6	ANODE B
7	ANODE A
8	COMMON CATHODE
9	ANODE F
10	ANODE G

Internal Circuit Diagram (Common Anode)

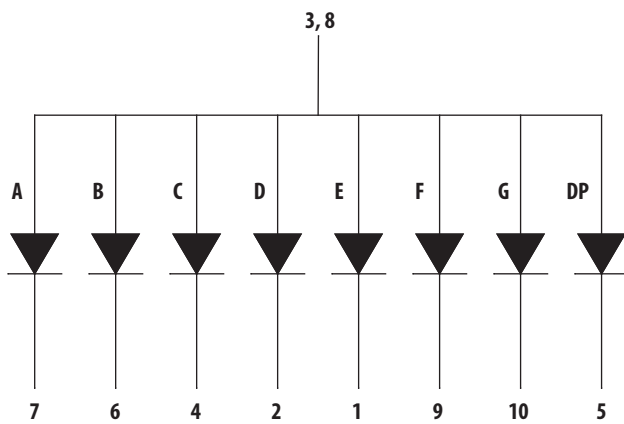

Internal Circuit Diagram (Common Cathode)

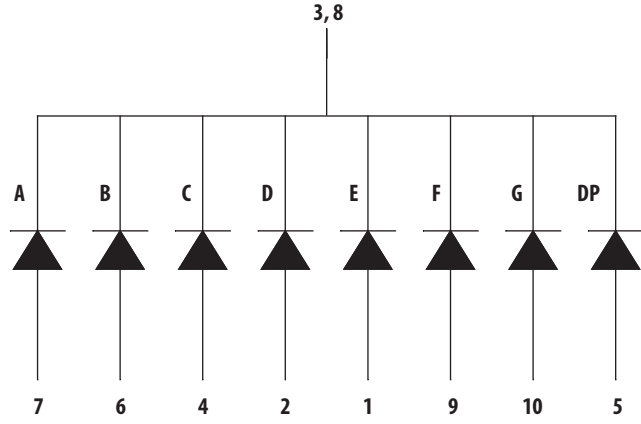

Absolute Maximum Ratings @ T_A=25°C

Parameter	White	Unit
Power Dissipation Per Segment	39	mW
Peak Forward Current Per Segment (1/10 Duty Cycle, 0.1ms pulse width)	80	mA
Continuous Forward Current Per Segment Derating Linearly From 25°C Per Segment	25 0.25	mA mA/°C
Reverse Voltage Per Segment	5	V
Operating Temperature Range		-40°C to +105°C
Storage Temperature Range		-40°C to +105°C

Electrical / Optical Characteristics @ T_A=25°C**White**

Parameter	Symbol	Min.	Typ.	Max.	Unit	Test Condition
Average Luminous Intensity	I _V	28	44	-	mcd	I _F = 5 mA
Chromaticity Coordinates	(X,Y)		Refer to Figure 1			I _F = 5 mA
Forward Voltage, Per Segment	V _F	-	2.95	3.8	V	I _F = 5 mA
Reverse Current, Per Segment	I _R	-	-	100	μA	V _R = 5 V
Luminous Intensity Matching Ratio	I _{V-m}	-	-	2:1	-	I _F = 5 mA

Typical Electrical / Optical characteristic Curves @ $T_A=25^\circ\text{C}$

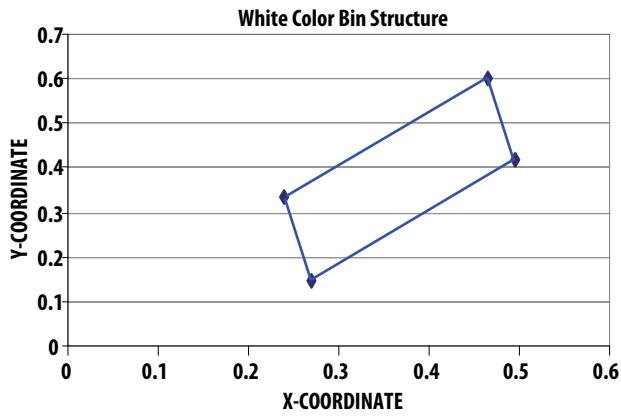

Figure 1. Color bin limit (CIE 1931 Chromatically Diagram)
[Tolerance: +/-0.02]

Chromaticity Coordinates				
X	0.24	0.495	0.269	0.465
Y	0.332	0.418	0.147	0.602

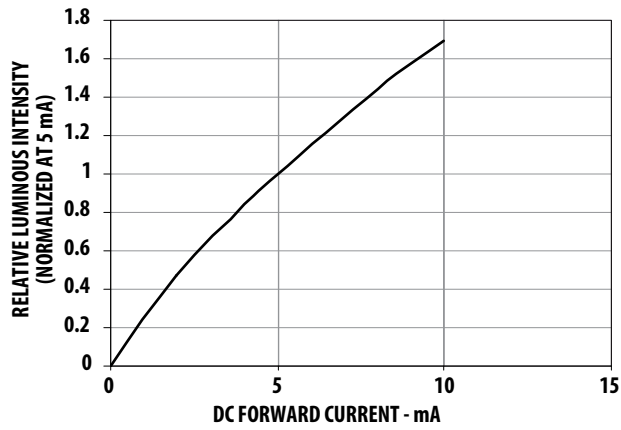

Figure 2. Relative luminous intensity versus forward current

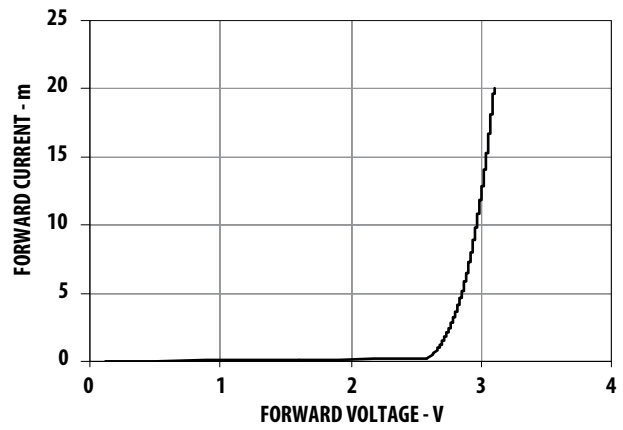

Figure 3. Forward current versus forward voltage

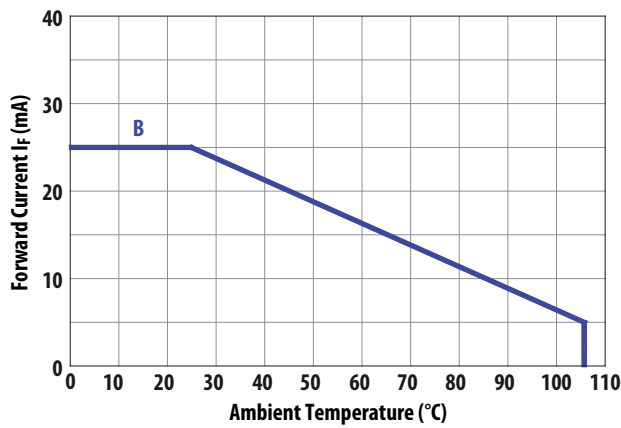
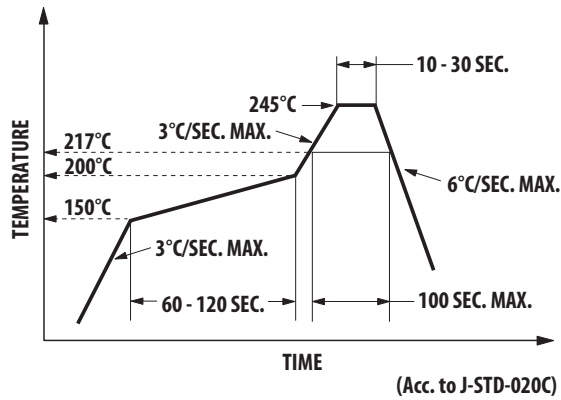

Figure 4. Allowable DC Current Versus Ambient Temperature

SMT Soldering Profile

Pb free reflow soldering Profile



Notes:

1. The peak temperature refers to the peak package body temperature.
2. Number of reflow process shall be limited to maximum 2 times only. Cooling process to normal temperature is required between first and second soldering process.

Recommended Soldering Pattern (unit: mm)

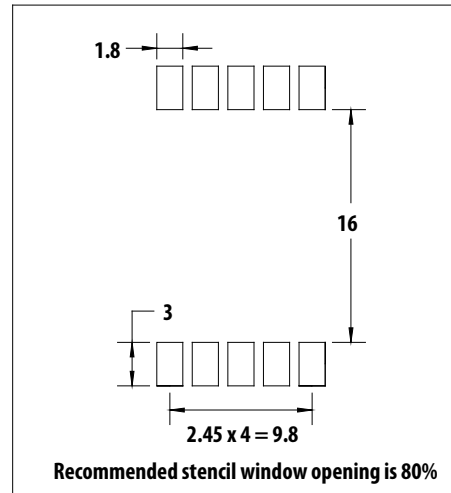

Tape Specification (unit: mm)

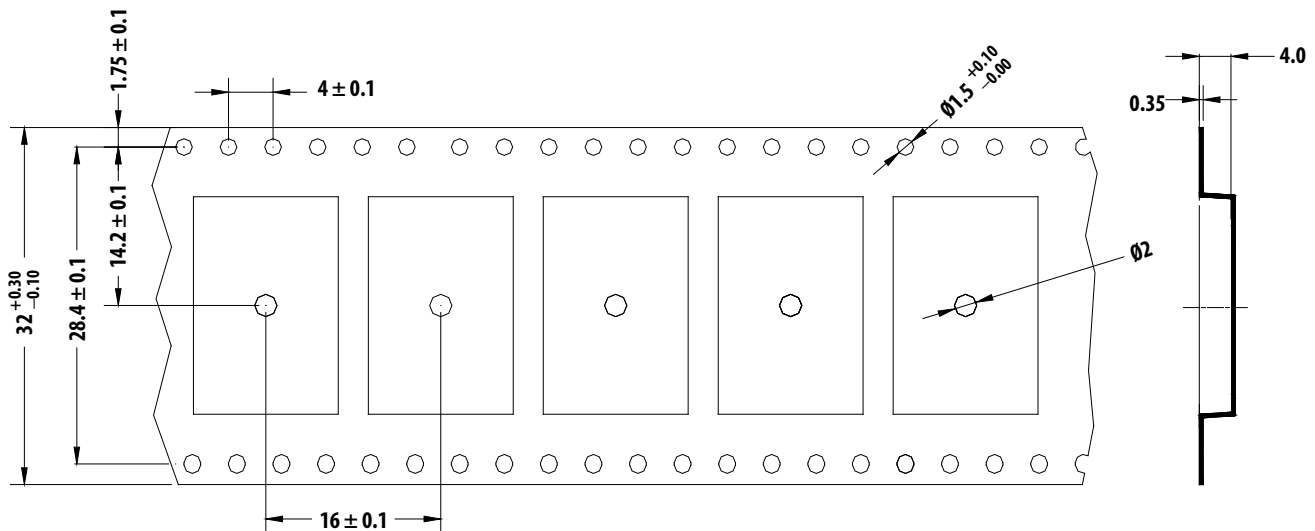

For product information and a complete list of distributors, please go to our web site: www.avagotech.com

Avago, Avago Technologies, and the A logo are trademarks of Avago Technologies in the United States and other countries. Data subject to change. Copyright © 2005-2011 Avago Technologies. All rights reserved. AV02-1642EN - March 17, 2011

AVAGO
TECHNOLOGIES