

Features

- LO 5 to 750 MHz
- RF 5 to 500 MHz
- IF DC to 500 MHz
- LO Drive +20 dBm (nominal)
- High Intercept Point +28.5 dBm (typ)
- High Isolation 45 dB (typ)

Description

The M6EH/SM6EH is a double balanced mixer, designed for use in military, commercial and test equipment applications. The design utilizes Schottky ring quad diodes and broadband ferrite baluns to attain excellent performance. This mixer can also be used as a phase detector and/or bi-phase modulator since the IF port is DC coupled to the diodes. Environmental screening available to MIL-STD-883, MIL-STD-202, or MIL-DTL-28837, consult factory.

Product Image

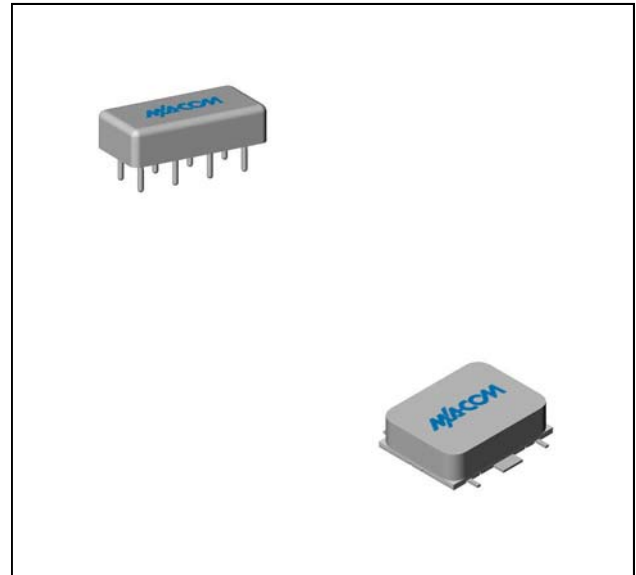

Ordering Information

Part Number	Package
M6EH	Relay Header
SM6EH	Surface Mount

Electrical Specifications: $Z_0 = 50\Omega$ $Lo = +20$ dBm (Downconverter application only)

Parameter	Test Conditions	Units	Typical	Guaranteed	
				+25°C	-54° to +85°C
SSB Conversion Loss (max)	fR = 10 to 100 MHz, fL = 10 to 100 MHz, fI = 10 to 100 MHz fR = 100 to 250 MHz, fL = 100 to 250 MHz, fI = 10 to 250 MHz fR = 5 to 500 MHz, fL = 5 to 750 MHz, fI = 0.5 to 500 MHz	dB	5.5	7.0	7.3
			6.0	7.5	7.8
			6.5	8.5	8.8
SSB Noise Figure (max)	Within 1 db of conversion loss	dB	—	—	—
Isolation, L to R (min)	fL = 5 to 200 MHz fL = 200 to 500 MHz fL = 500 to 750 MHz	dB	60	40	39
			45	30	29
			35	20	19
Isolation, L to I (min)	fL = 5 to 200 MHz fL = 200 to 500 MHz fL = 500 to 750 MHz	dB	55	40	39
			40	25	24
			30	18	17
1 dB Conversion Comp.	fL = +20 dBm	dBm	+13		
Input IP3	fR1 = 250 MHz 0 dBm, fR2 = 260 MHz 0 dBm, fL = 300 MHz +20 dBm	dBm	+28.5		

Typical Performance Curves

Conversion Loss vs. LO Drive Level

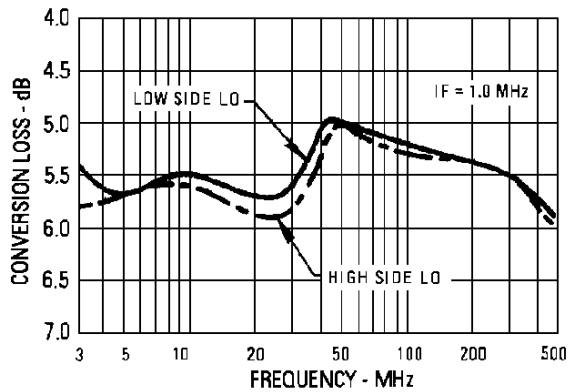
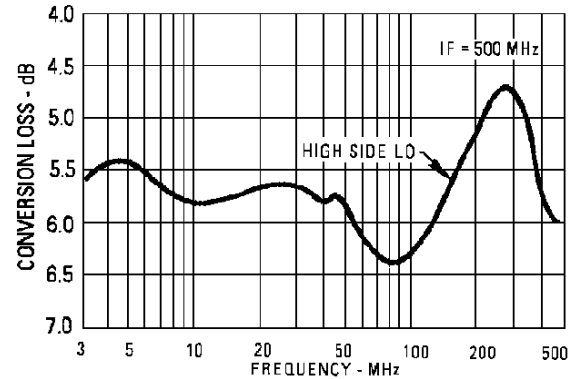
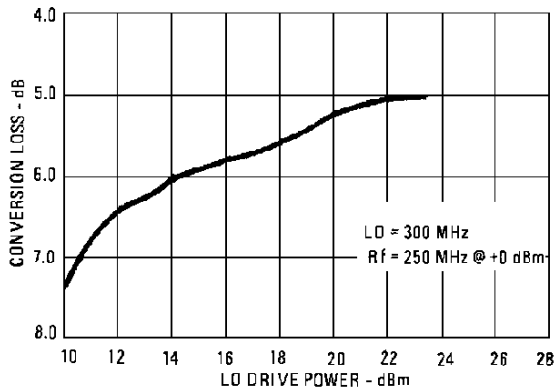

Isolation

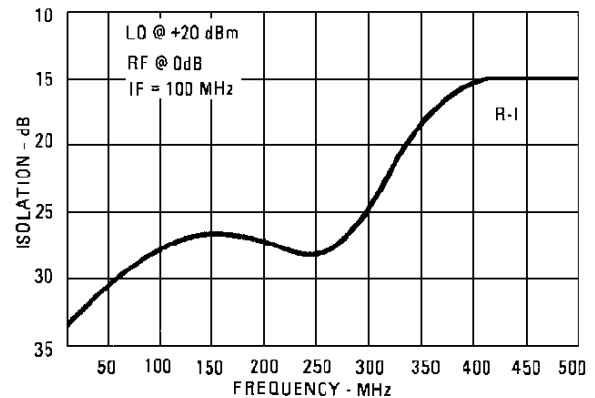
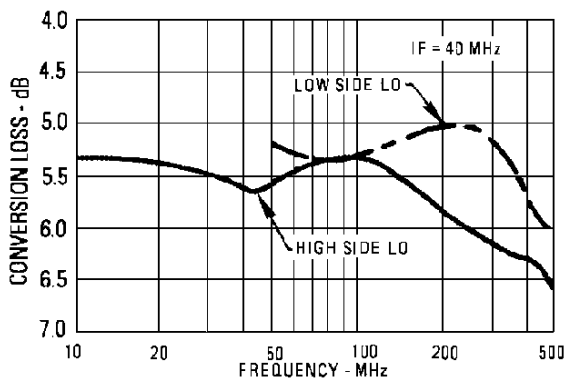
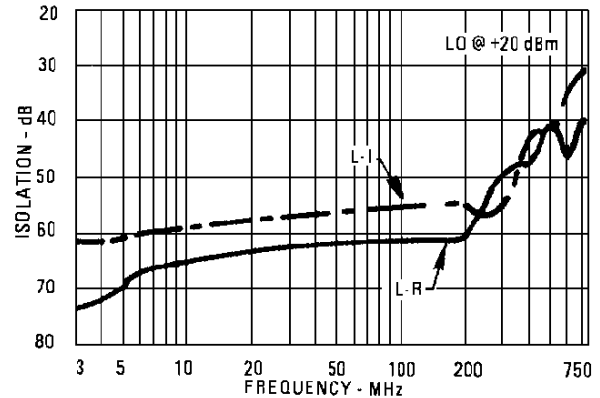

Absolute Maximum Ratings

Parameter	Absolute Maximum
Operating Temperature	-54°C to +100°C
Storage Temperature	-65°C to +100°C
Peak Input Power	+26 dBm max @ +25°C
Peak Input Current	50 mA DC

Outline Drawing: Relay Header *

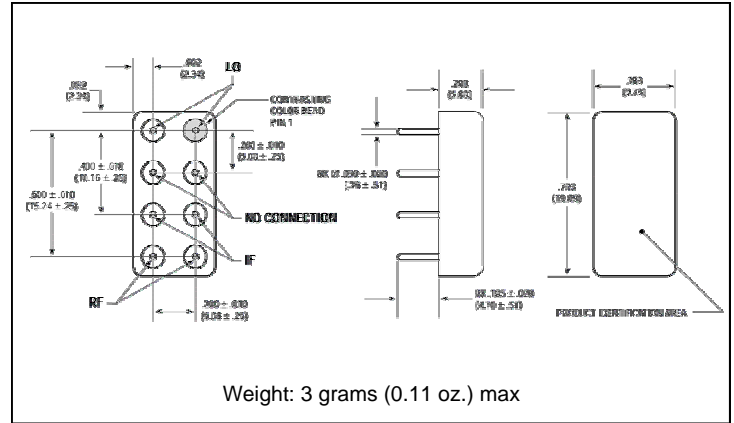

L-Port VSWR

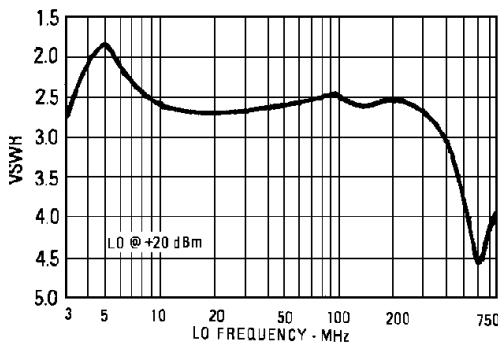

R-Port VSWR

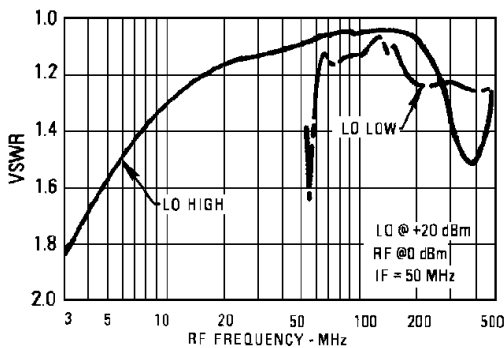

Outline Drawing: Surface Mount *

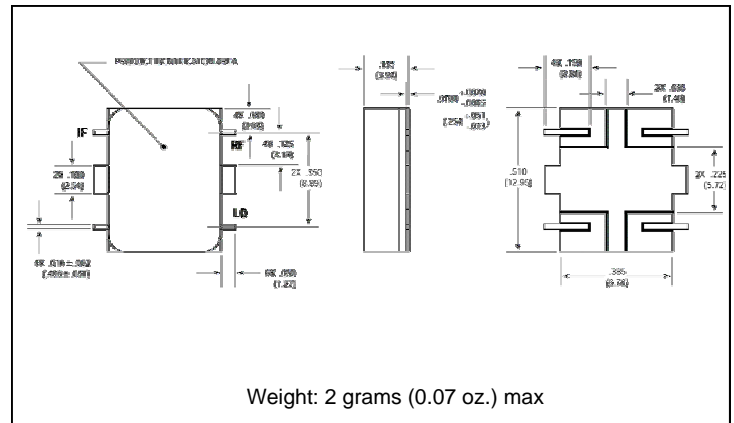

* Dimensions are inches (millimeters) ±0.015 (0.38) unless otherwise specified.

I-Port VSWR

