

**MALE COAXIPACK 6 WAYS 4 RIGHT ANGLE COA**

**R694.251.114**

**SOLDER TYPE 2.5**

Series : MCC2

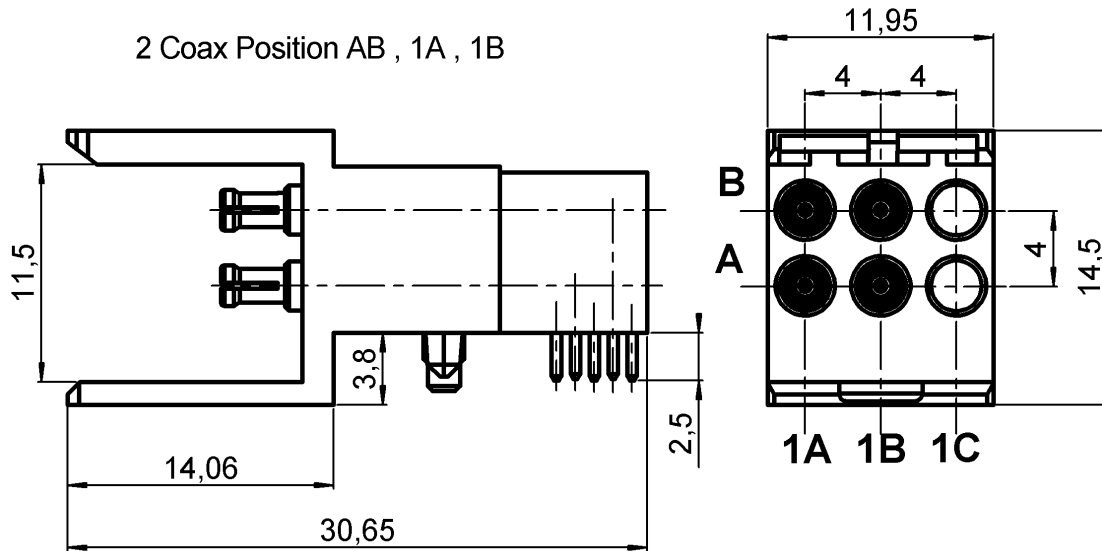

Packaging for the connector

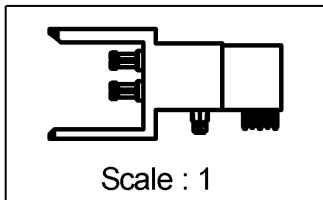
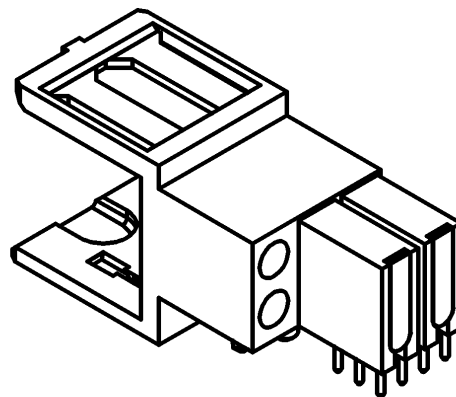
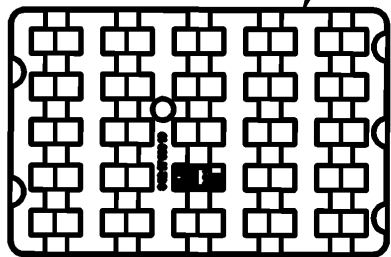

All dimensions are in mm.

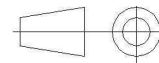

COMPONENTS	MATERIALS	PLATING (µm)
BODY	BRASS	NICKEL 2
CENTER CONTACT	BERYLLIUM COPPER	NPGR
OUTER CONTACT	BRONZE	NPGR
INSULATOR	PEEK , ULTEM	
GASKET	-	
OTHERS PARTS	LIQUID CRISTAL POLYMER	
.	.	.
.	.	.

Issue : 0627 B

In the effort to improve our products, we reserve the right to make changes judged to be necessary.



**MALE COAXIPACK 6 WAYS 4 RIGHT ANGLE COA**

**R694.251.114**

**SOLDER TYPE 2.5**

Series : MCC2

**PACKAGING**

**SPECIFICATION**

Standard	Unit	Other
<b>25</b>	<b>'W' option</b>	<b>Contact us</b>

**ELECTRICAL CHARACTERISTICS**

**ENVIRONMENTAL**

Impedance	<b>50</b>	$\Omega$
Frequency	<b>0-6</b>	GHz
VSWR	<b>1.20* + 0,0000</b>	x F(GHz) Maxi
Insertion loss	<b>0.2</b>	$\sqrt{F}$ (GHz) dB Maxi
RF leakage	- (	- F(GHz)) dB Maxi
Voltage rating	<b>500</b>	Veff Maxi
Dielectric withstanding voltage	<b>750</b>	Veff mini
Insulation resistance	<b>5000</b>	M $\Omega$ mini

Operating temperature	<b>-25/+125</b>	$^{\circ}$ C
Hermetic seal	<b>NA</b>	Atm.cm3/s
Panel leakage	<b>NA</b>	

**OTHER CHARACTERISTICS**

Assembly instruction

Others :  
VSWR optimized between DC to 3GHz

**MECHANICAL CHARACTERISTICS**

Center contact retention		
Axial force – Mating end	<b>6</b>	N mini
Axial force – Opposite end	<b>6</b>	N mini
Torque	<b>NA</b>	N.cm mini
Recommended torque		
Mating	<b>NA</b>	N.cm
Panel nut	<b>NA</b>	N.cm
Mating life	<b>500</b>	Cycles mini
Weight	<b>81,5600</b>	g

Issue : 0627 B

In the effort to improve our products, we reserve the right to make changes judged to be necessary.



**MALE COAXIPACK 6 WAYS 4 RIGHT ANGLE COA**  
**SOLDER TYPE 2.5**

**R694.251.114**

Series : MCC2

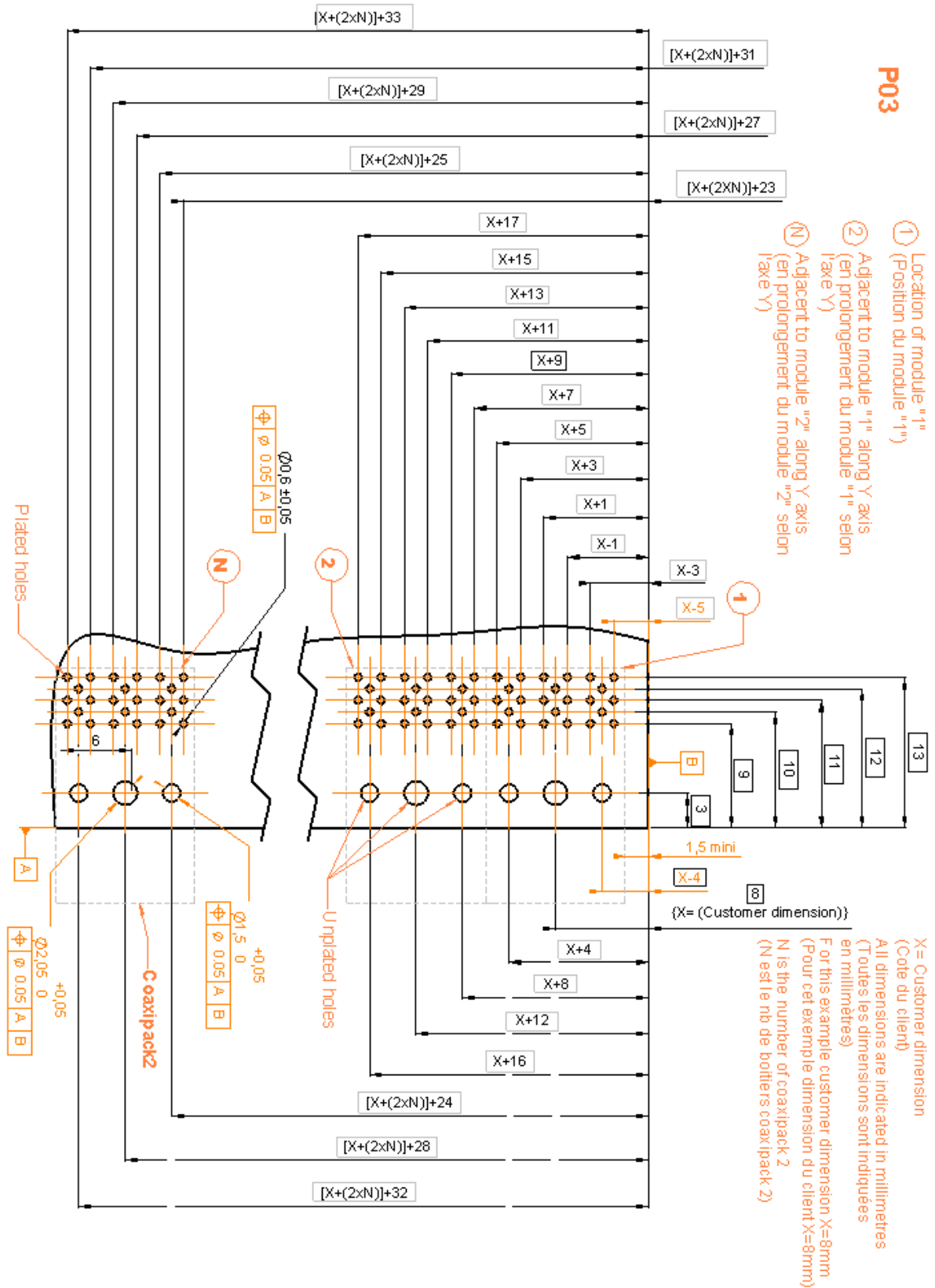

Issue : 0627 B

In the effort to improve our products, we reserve the right to make changes judged to be necessary.



**RADIALL**®

**MALE COAXIPACK 6 WAYS 4 RIGHT ANGLE COA**

**R694.251.114**

**SOLDER TYPE 2.5**

Series : MCC2

- Place the coax connector on the PCB

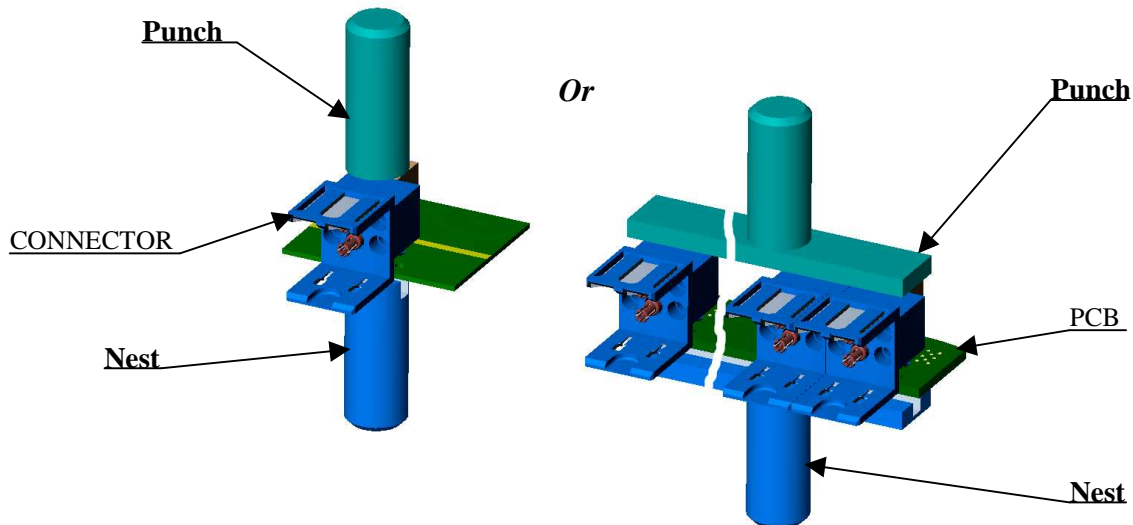

- Place correctly the PCB between the punch and the nest of the press.
- In case of multiple housing configuration , use a punch and a nest large enough to cover all the housings.
- Press on the plastic housing(s) with the punch until the complete insertion of the fixing stud into the PCB.

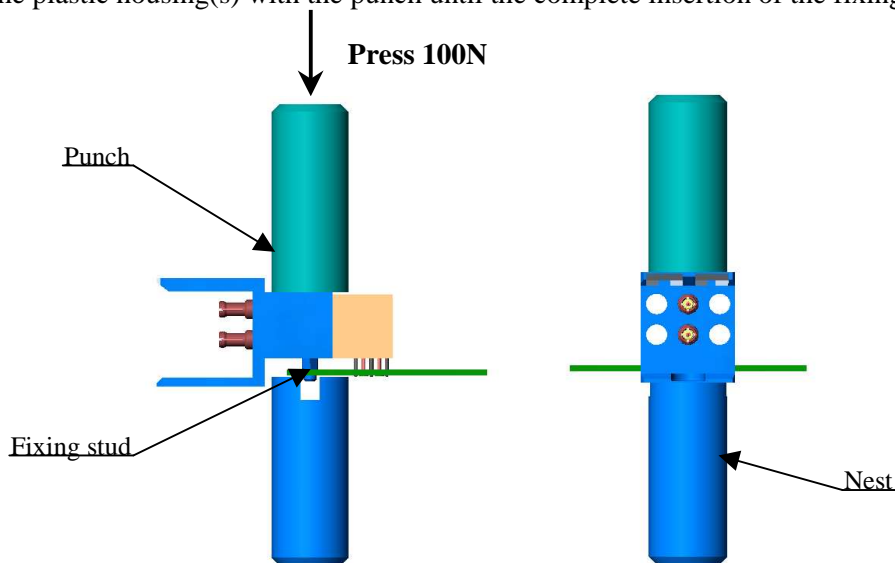

- Solder the legs on board

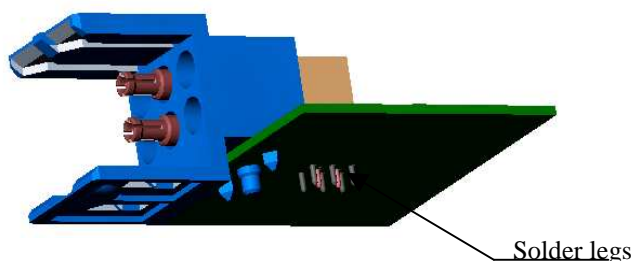

Radiall do not recommend to use more than 3 modules on the same motherboard and can't be held liable of any connection defect when more than 3 modules are implemented on the board

Issue : 0627 B

In the effort to improve our products, we reserve the right to make changes judged to be necessary.

