

---

**ALPHA WIRE COMPANY**  
**CUSTOMER PRODUCT SPECIFICATION**

---

Part Number: 778  
Page 1 of 2 Pages

Issue: 3  
Issue Date: 5/20/2004  
Effective Date: 6/30/2004

---

**A. Cordage Construction**

- 1) Conductor
  - a) Material Bare Copper Per ASTM B-3
  - b) AWG, Stranding 18, 16/30; Finer stranding may be used.
  
- 2) Insulation
  - a) Material Rubber
  - b) Min. Avg. Wall Thickness 0.030
  - c) Nominal Diameter 0.107
  
- 3) Core Assembly
  - a) Number of Conductors 3
  - b) Color Code Black, White & Green/Yellow or Black, White & Green within Munsell® Component extended limits of deviation.  
*[Note: The stripe of the Green/Yellow insulation shall be 50% +/- 20%.]*
  - c) Fillers Optional
  - d) Separator Tissue Paper
  
- 4) Jacket
  - a) Material Rubber
  - b) Surface Finish Smooth, non-striated
  - c) Min. Avg. Wall Thickness 0.030
  - d) Nominal Diameter 0.320
  - e) Color Black; within Munsell® Component limits of deviation
  - f) UL, CSA Type SJ\*\*, Minimum
  - g) Jacket Marking Per UL Standard 62 and CSA C22.2 No. 49.

\*\* Cordage Types with a UL/CSA rating greater than Type SJ may be substituted.

**B. Cord Configuration**

- 1) End 1 Molded Vinyl Grounding Plug, NEMA 5-15P
- 2) End 2 Jacket Stripped 1.5" +/- .125"  
Insulation Stripped 0.625" +/- 0.0625"
- 3) Mold Color Black
- 4) Overall Length 96" +/- 1"

---

**ALPHA WIRE COMPANY**  
**CUSTOMER PRODUCT SPECIFICATION**

---

Part Number: 778  
Page 2 of 2 Pages

Issue: 3  
Issue Date: 5/20/2004  
Effective Date: 6/30/2004

---

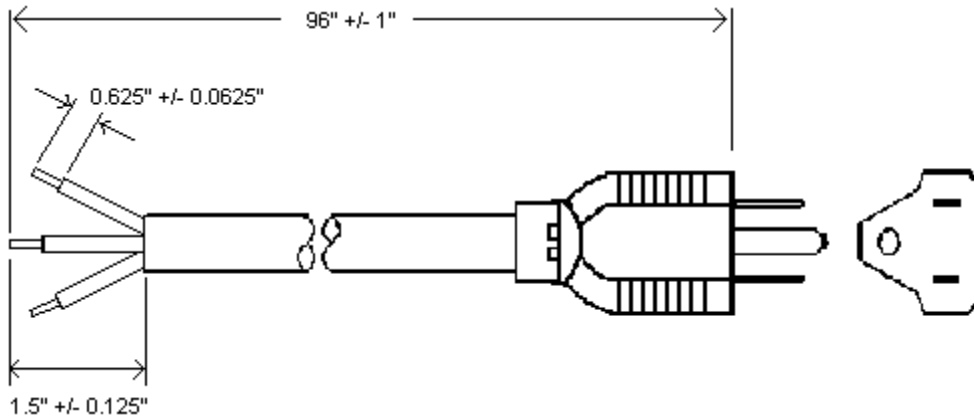

**C. Industry Approvals and Ratings**

- |                       |                  |
|-----------------------|------------------|
| 1) UL                 | UL Standard 817  |
| 2) CSA                | CSA C22.2 No. 21 |
| 3) Voltage Rating     | 125 Vrms         |
| 4) Current Rating     | 10 Amps          |
| 5) Temperature Rating | 60°C, Minimum    |