

# TS391, NCV391

## Low Power Single Voltage Comparator

### Description

The TS391 is an open collector, low-power voltage comparator designed specifically to operate from a single supply over a wide range of voltages. Operation from split power supplies is also possible.

This comparator also has a unique characteristic in that the input common-mode voltage range includes ground, even though operated from a single power supply voltage.

### Features

- Wide Single Supply Voltage Range or Dual Supplies
- Low Supply Current (0.5 mA) Independent of Supply Voltage (1 mW/Comparator at +5 V)
- Low Input Bias Current: 25 nA TYP
- Low Input Offset Current:  $\pm 5$  nA TYP
- Low Input Offset Voltage:  $\pm 1$  mV TYP
- Input Common Mode Voltage Range includes Ground
- Low Output Saturation Voltage: 250 mV TYP at  $I_O = 4$  mA
- Differential Input Voltage Range Equal to the Supply Voltage
- TTL, DTL, ECL, CMOS Compatible Devices
- These Devices are Pb-Free, Halogen Free/BFR Free and are RoHS Compliant
- NCV Prefix for Automotive and Other Applications Requiring Unique Site and Control Change Requirements; AEC-Q100 Qualified and PPAP Capable

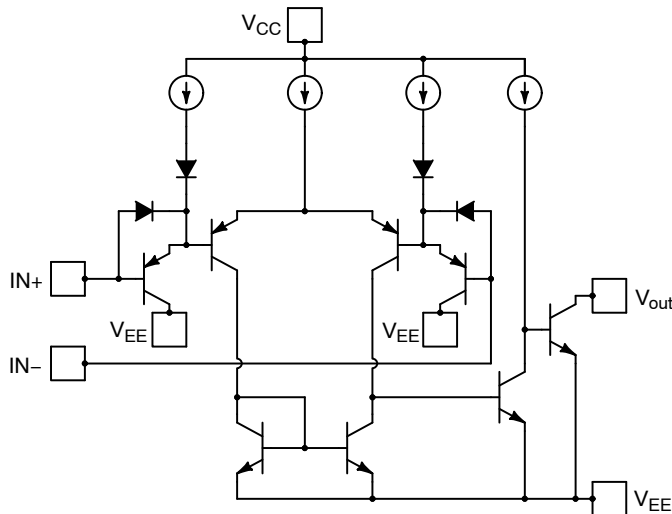

**ON Semiconductor®**

<http://onsemi.com>



**TSOP-5  
SN SUFFIX  
CASE 483**

### MARKING DIAGRAM

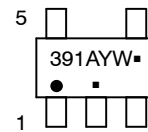

**Analog**

391 = Specific Device Code  
A = Assembly Location  
Y = Year  
W = Work Week  
▪ = Pb-Free Package

(Note: Microdot may be in either location)

### PIN CONNECTIONS

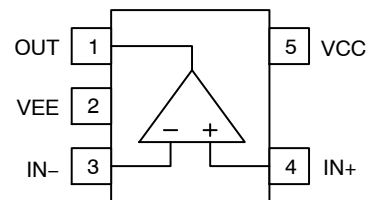

### ORDERING INFORMATION

| Device        | Package             | Shipping†          |
|---------------|---------------------|--------------------|
| TS391SN2T1G   | TSOP-5<br>(Pb-Free) | 3000 / Tape & Reel |
| NCV391SN2T1G* | TSOP-5<br>(Pb-Free) | 3000 / Tape & Reel |

† For information on tape and reel specifications, including part orientation and tape sizes, please refer to our Tape and Reel Packaging Specification Brochure, BRD8011/D.

\* NCV Prefix for Automotive and Other Applications Requiring Unique Site and Control Change Requirements; AEC-Q100 Qualified and PPAP Capable

# TS391, NCV391

**Table 1. ABSOLUTE MAXIMUM RATINGS** (Over operating free-air temperature, unless otherwise stated)

| Parameter                            | Symbol | Limit | Unit |
|--------------------------------------|--------|-------|------|
| Supply Voltage ( $V_{CC} - V_{EE}$ ) | $V_S$  | 36    | V    |

**INPUT AND OUTPUT PINS**

|                                       |          |            |    |
|---------------------------------------|----------|------------|----|
| Input Voltage                         | $V_{IN}$ | $\pm 36$   | V  |
| Differential Input Voltage            | $V_{ID}$ | -0.3 to 36 | V  |
| Output Short Circuit Current (Note 1) | $I_{SC}$ | 20         | mA |

**TEMPERATURE**

|                      |           |             |             |
|----------------------|-----------|-------------|-------------|
| Storage Temperature  | $T_{STG}$ | -65 to +150 | $^{\circ}C$ |
| Junction Temperature | $T_J$     | +150        | $^{\circ}C$ |

**ESD RATINGS**

|                      |     |      |   |
|----------------------|-----|------|---|
| Human Body Model     | HBM | 1500 | V |
| Charged Device Model | CDM | 2000 | V |
| Machine Model        | MM  | 200  | V |

Stresses exceeding those listed in the Maximum Ratings table may damage the device. If any of these limits are exceeded, device functionality should not be assumed, damage may occur and reliability may be affected.

- Short circuits from the output to  $V_{CC}$  can cause excessive heating and potential destruction. The maximum short circuit current is independent of the magnitude of  $V_{CC}$ .

**Table 2. THERMAL INFORMATION** (Note 2)

| Thermal Metric              | Symbol        | Limit | Unit          |
|-----------------------------|---------------|-------|---------------|
| Junction to Ambient – SOIC8 | $\theta_{JA}$ | 238   | $^{\circ}C/W$ |

- Short-circuits can cause excessive heating and destructive dissipation. These values are typical.

**Table 3. OPERATING CONDITIONS**

| Parameter                 | Symbol | Limit       | Unit        |
|---------------------------|--------|-------------|-------------|
| Operating Supply Voltage  | $V_S$  | 2 to 36     | V           |
| Specified Operating Range | $T_A$  | -40 to +125 | $^{\circ}C$ |

Functional operation above the stresses listed in the Recommended Operating Ranges is not implied. Extended exposure to stresses beyond the Recommended Operating Ranges limits may affect device reliability.

# TS391, NCV391

**Table 4. ELECTRICAL CHARACTERISTICS** ( $V_S = +5.0$  V, At  $T_A = +25^\circ\text{C}$ )

**Boldface** limits apply over the specified temperature range,  $T_A = -40^\circ\text{C}$  to  $+125^\circ\text{C}$ .

| Parameter                           | Symbol    | Conditions  | Min      | Typ | Max                            | Unit                            |
|-------------------------------------|-----------|---|----------|-----|--------------------------------|---------------------------------|
| <b>INPUT CHARACTERISTICS</b>        |           |   |          |     |                                |                                 |
| Offset Voltage                      | $V_{OS}$  | $V_O = 1.4$ V, $R_S = 0$ $\Omega$ , $V_S = 5$ V to 30 V, $V_{CM} = 0$ to $V_{CC} - 1.5$ V |          | 1   | 5                              | mV                              |
|                                     |           |   |          |     | <b>9</b>                       | <b>mV</b>                       |
| Input Bias Current                  | $I_{IB}$  |   |          | 25  | 250                            | nA                              |
|                                     |           |   |          |     | <b>400</b>                     | <b>nA</b>                       |
| Input Offset Current                | $I_{OS}$  |   |          | 5   | 50                             | nA                              |
|                                     |           |   |          |     | <b>150</b>                     | <b>nA</b>                       |
| Input Common Mode Range (Note 3)    | $V_{ICR}$ |   | 0        |     | $V_{CC} - 1.5$                 | V                               |
|                                     |           |   | <b>0</b> |     | <b><math>V_{CC} - 2</math></b> | <b>V</b>                        |
| Differential Input Voltage (Note 4) | $V_{ID}$  |   |          |     | $V_{CC}$                       | V                               |
| <b>OUTPUT CHARACTERISTICS</b>       |           |   |          |     |                                |                                 |
| Output Voltage Low                  | $V_{OL}$  | $V_{ID} = 1$ V, $I_O = 4$ mA  |          | 250 | 400                            | mV                              |
|                                     |           |   |          |     | <b>700</b>                     | <b>mV</b>                       |
| Output Sink Current                 | $I_O$     | $V_{ID} = -1$ , $V_O = 1.5$ V   | 6        | 16  |                                | mA                              |
| Output Leakage Current              | $I_{OH}$  | $V_{ID} = 1$ V, $V_{CC} = V_O = 5$ V  |          | 0.1 |                                | nA                              |
|                                     |           | $V_{ID} = 1$ V, $V_{CC} = V_O = 30$ V   |          |     | <b>1</b>                       | <b><math>\mu\text{A}</math></b> |
| <b>DYNAMIC PERFORMANCE</b>          |           |   |          |     |                                |                                 |
| Open Loop Voltage Gain              | $A_{VOL}$ | $V_{CC} = 15$ V, $R_{PU} = 15$ k $\Omega$   | 94       | 106 |                                | dB                              |
| Propagation Delay L-H               | $t_{PLH}$ | 5 mV overdrive, $R_{PU} = 5.1$ k $\Omega$   |          | 850 |                                | ns                              |
|                                     |           | 20 mV overdrive, $R_{PU} = 5.1$ k $\Omega$  |          | 490 |                                | ns                              |
|                                     |           | 100 mV overdrive, $R_{PU} = 5.1$ k $\Omega$   |          | 300 |                                | ns                              |
|                                     |           | TTL Input, $V_{ref} = +1.4$ V, $R_{PU} = 5.1$ k $\Omega$                                  |          | 220 |                                | ns                              |
| Propagation Delay H-L               | $t_{PHL}$ | 5 mV overdrive, $R_{PU} = 5.1$ k $\Omega$   |          | 620 |                                | ns                              |
|                                     |           | 20 mV overdrive, $R_{PU} = 5.1$ k $\Omega$  |          | 400 |                                | ns                              |
|                                     |           | 100 mV overdrive, $R_{PU} = 5.1$ k $\Omega$   |          | 250 |                                | ns                              |
|                                     |           | TTL Input, $V_{ref} = +1.4$ V, $R_{PU} = 5.1$ k $\Omega$                                  |          | 350 |                                | ns                              |
| <b>POWER SUPPLY</b>                 |           |   |          |     |                                |                                 |
| Quiescent Current                   | $I_{CC}$  | $V_{CC} = 5$ V  |          | 0.5 | -                              | mA                              |
|                                     |           | $V_{CC} = 30$ V   |          | 0.5 | 1.25                           | mA                              |

Product parametric performance is indicated in the Electrical Characteristics for the listed test conditions, unless otherwise noted. Product performance may not be indicated by the Electrical Characteristics if operated under different conditions.

- The input common mode voltage of either input signal should not be allowed to go negative by more than 0.3 V. The upper end of the common mode voltage range is  $V_{CC} - 1.5$  V, but either or both inputs can go to +30 V without damage.
- Positive excursions of the input voltage may exceed the power supply level. As long as the other voltage remains within the common mode range, the comparator will provide a proper output stage. The low input voltage state must not be less than 0.3 V below the negative supply rail.

# TS391, NCV391

## TYPICAL CHARACTERISTICS

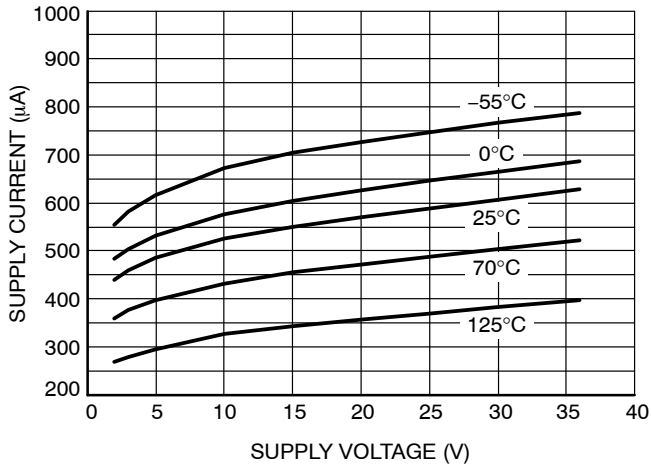

Figure 1. Supply Current vs. Supply Voltage

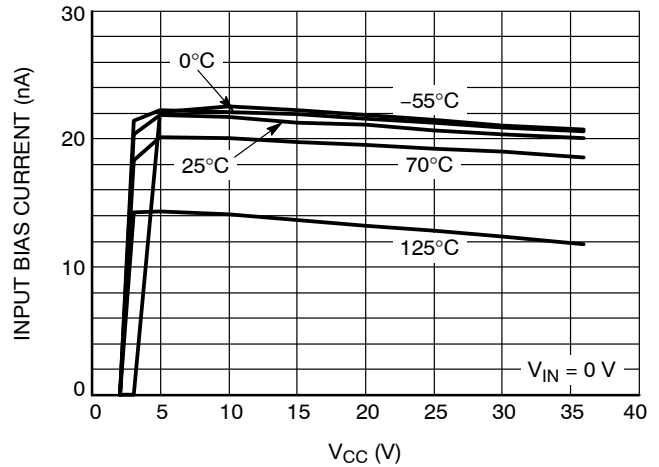

Figure 2. Input Bias Current vs.  $V_{CC}$

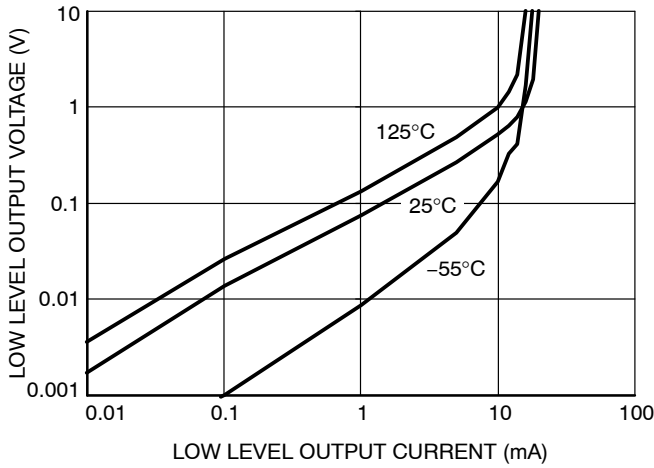

Figure 3. Low Level Output Voltage vs. Output Current

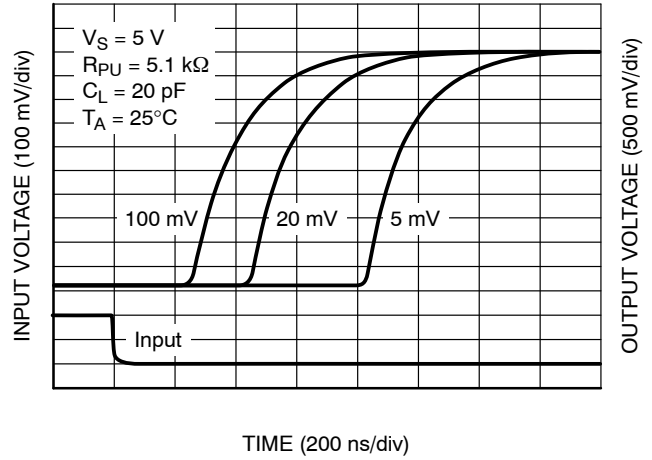

Figure 4. Propagation Delay L-H vs. Overdrive

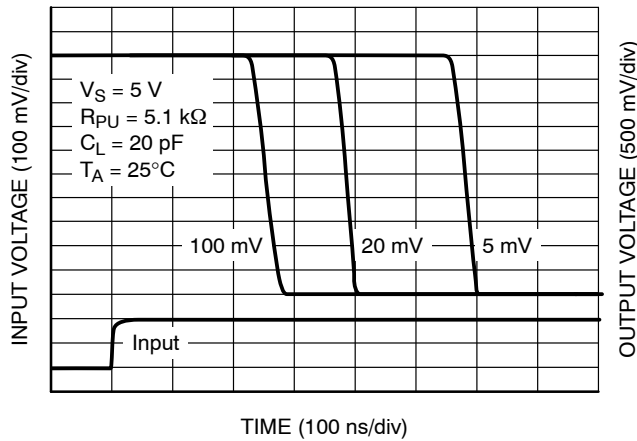
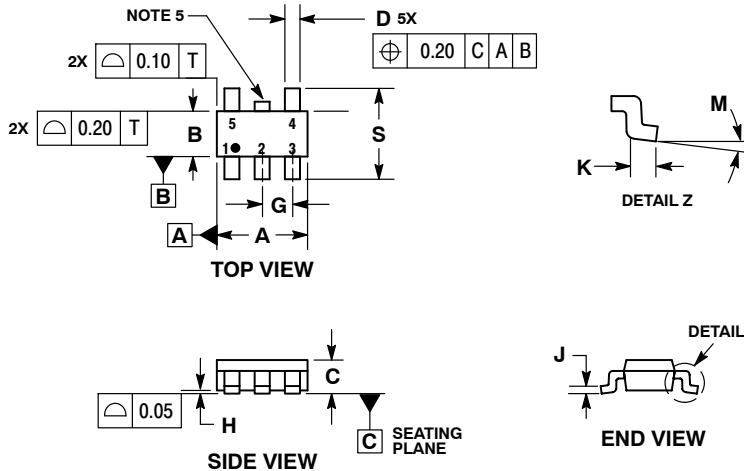

Figure 5. Propagation Delay H-L vs. Overdrive

# TS391, NCV391

## PACKAGE DIMENSIONS

### TSOP-5 CASE 483-02 ISSUE K



**NOTES:**

1. DIMENSIONING AND TOLERANCING PER ASME Y14.5M, 1994.
2. CONTROLLING DIMENSION: MILLIMETERS.
3. MAXIMUM LEAD THICKNESS INCLUDES LEAD FINISH THICKNESS. MINIMUM LEAD THICKNESS IS THE MINIMUM THICKNESS OF BASE MATERIAL.
4. DIMENSIONS A AND B DO NOT INCLUDE MOLD FLASH, PROTRUSIONS, OR GATE BURRS. MOLD FLASH, PROTRUSIONS, OR GATE BURRS SHALL NOT EXCEED 0.15 PER SIDE. DIMENSION A.
5. OPTIONAL CONSTRUCTION: AN ADDITIONAL TRIMMED LEAD IS ALLOWED IN THIS LOCATION. TRIMMED LEAD NOT TO EXTEND MORE THAN 0.2 FROM BODY.

| DIM | MILLIMETERS |      |
|-----|-------------|------|
|     | MIN         | MAX  |
| A   | 3.00 BSC    |      |
| B   | 1.50 BSC    |      |
| C   | 0.90        | 1.10 |
| D   | 0.25        | 0.50 |
| G   | 0.95 BSC    |      |
| H   | 0.01        | 0.10 |
| J   | 0.10        | 0.26 |
| K   | 0.20        | 0.60 |
| M   | 0°          | 10°  |
| S   | 2.50        | 3.00 |

### SOLDERING FOOTPRINT\*

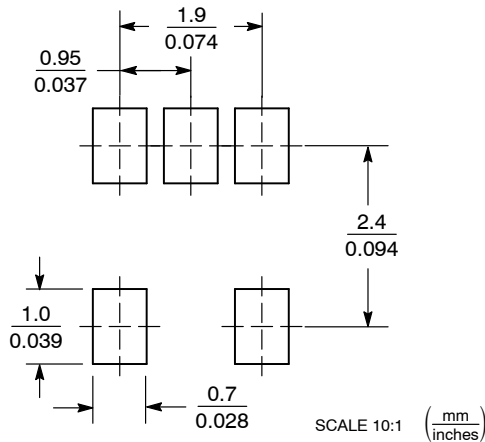

\*For additional information on our Pb-Free strategy and soldering details, please download the ON Semiconductor Soldering and Mounting Techniques Reference Manual, SOLDERRM/D.

ON Semiconductor and are registered trademarks of Semiconductor Components Industries, LLC (SCILLC). SCILLC owns the rights to a number of patents, trademarks, copyrights, trade secrets, and other intellectual property. A listing of SCILLC's product/patent coverage may be accessed at [www.onsemi.com/site/pdf/Patent-Marking.pdf](http://www.onsemi.com/site/pdf/Patent-Marking.pdf). SCILLC reserves the right to make changes without further notice to any products herein. SCILLC makes no warranty, representation or guarantee regarding the suitability of its products for any particular purpose, nor does SCILLC assume any liability arising out of the application or use of any product or circuit, and specifically disclaims any and all liability, including without limitation special, consequential or incidental damages. "Typical" parameters which may be provided in SCILLC data sheets and/or specifications can and do vary in different applications and actual performance may vary over time. All operating parameters, including "Typicals" must be validated for each customer application by customer's technical experts. SCILLC does not convey any license under its patent rights nor the rights of others. SCILLC products are not designed, intended, or authorized for use as components in systems intended for surgical implant into the body, or other applications intended to support or sustain life, or for any other application in which the failure of the SCILLC product could create a situation where personal injury or death may occur. Should Buyer purchase or use SCILLC products for any such unintended or unauthorized application, Buyer shall indemnify and hold SCILLC and its officers, employees, subsidiaries, affiliates, and distributors harmless against all claims, costs, damages, and expenses, and reasonable attorney fees arising out of, directly or indirectly, any claim of personal injury or death associated with such unintended or unauthorized use, even if such claim alleges that SCILLC was negligent regarding the design or manufacture of the part. SCILLC is an Equal Opportunity/Affirmative Action Employer. This literature is subject to all applicable copyright laws and is not for resale in any manner.

### PUBLICATION ORDERING INFORMATION

**LITERATURE FULFILLMENT:**  
Literature Distribution Center for ON Semiconductor  
P.O. Box 5163, Denver, Colorado 80217 USA  
Phone: 303-675-2175 or 800-344-3860 Toll Free USA/Canada  
Fax: 303-675-2176 or 800-344-3867 Toll Free USA/Canada  
Email: [orderlit@onsemi.com](mailto:orderlit@onsemi.com)

**N. American Technical Support:** 800-282-9855 Toll Free  
USA/Canada  
**Europe, Middle East and Africa Technical Support:**  
Phone: 421 33 790 2910  
**Japan Customer Focus Center**  
Phone: 81-3-5817-1050

**ON Semiconductor Website:** [www.onsemi.com](http://www.onsemi.com)  
**Order Literature:** <http://www.onsemi.com/orderlit>

For additional information, please contact your local Sales Representative