

Description

The TLV27x provides a higher performance alternative to the TLC27x series of op-amps. These devices take the minimum operating supply voltage down to 2.7V over the extended industrial temperature range while adding the rail-to-rail output swing feature.

This makes it an ideal alternative to the TLC27x family for applications where rail-to-rail output swings are essential. The TLV27x also provides 2-MHz bandwidth from only 550µA supply current.

The TLV27x is fully specified for 5V and ±5V supplies. The maximum recommended supply voltage is 16V. The devices can be operated from a variety of rechargeable cells from ±8V down to ±1.35V.

The CMOS inputs enable use in high-impedance sensor interfaces, with the lower voltage operation making an attractive alternative for the TLC27x in battery-powered applications.

The 2.7-V operation makes it compatible with Li-Ion powered systems and the operating supply voltage range of many micro-power micro-controllers available today.

All parts are available in SOIC packaging; the TLV271 is additionally available in the SOT25 package. Two temperature grades are available for the parts; C grade offers 0 to +70°C operating, I grade offers -40°C to +125°C operating.

Features

- High performance alternative to TLC27x series
- Rail to rail output
- Wide bandwidth: 2MHz
- High slew rate: 2.0 V/µs
- Wide range of supply voltages: 2.7V to 16V
- Low supply current: 550µA per channel
- Low input noise voltage: 35nV/√Hz
- Low input bias current: 1pA
- Specified temperature ranges:
 - 0°C to +70°C: commercial grade
 - -40°C to +125°C: industrial grade
- **Totally Lead-Free & Fully RoHS Compliant (Notes 1 & 2)**
- **Halogen and Antimony Free. "Green" Device (Note 3)**

Notes: 1. No purposely added lead. Fully EU Directive 2002/95/EC (RoHS) & 2011/65/EU (RoHS 2) compliant.
 2. See http://www.diodes.com/quality/lead_free.html for more information about Diodes Incorporated's definitions of Halogen- and Antimony-free, "Green" and Lead-free.
 3. Halogen- and Antimony-free "Green" products are defined as those which contain <900ppm bromine, <900ppm chlorine (<1500ppm total Br + Cl) and <1000ppm antimony compounds.

Pin Assignments

(Top View)

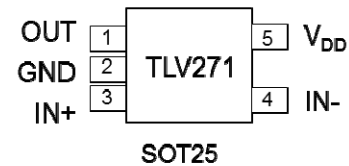

(Top View)

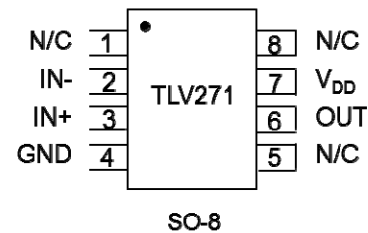

(Top View)

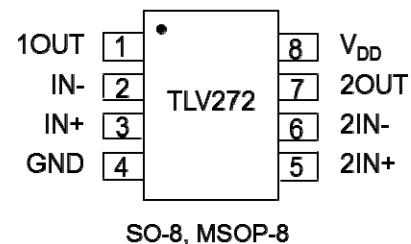

Simplified Schematic Diagram

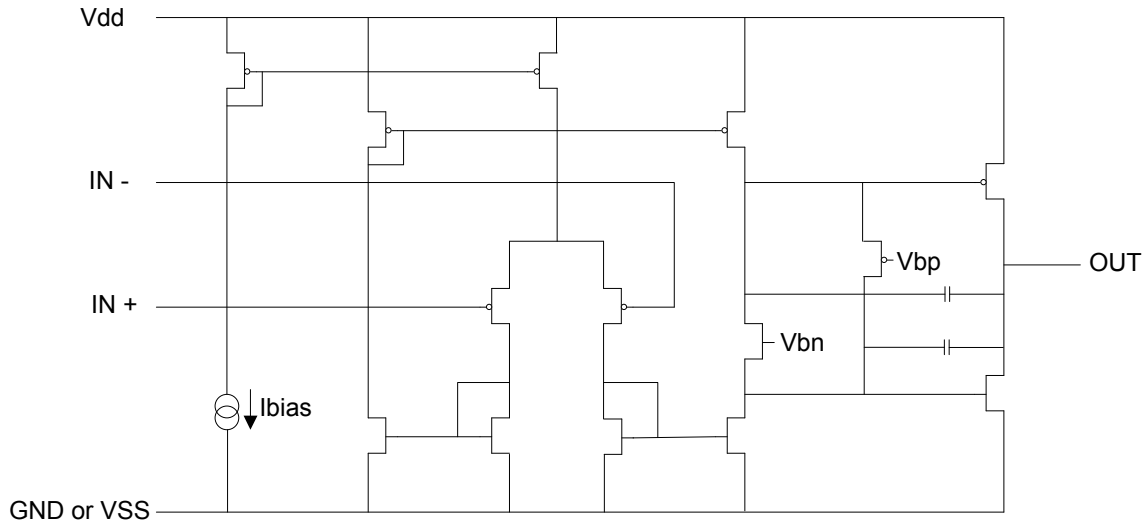

Pin Descriptions

Pin Number		TLV271		TLV272	
SOT25	SO-8/ MSOP-8	Pin Name	Function	Pin Name	Function
	1	N/C	No connection	1OUT	Output op-amp 1
4	2	IN-	Inverting input	1IN-	Inverting input op-amp 1
3	3	IN+	Non-inverting input	1IN+	Non-inverting input op-amp 1
2	4	GND	Ground	GND	Ground
	5	N/C	No connection	2IN+	Non inverting input op-amp 2
1	6	OUT	Output	2IN-	Inverting input op-amp 2
5	7	V _{DD}	Supply	2OUT	Output op-amp 2
	8	N/C	No connection	V _{DD}	Supply

Absolute Maximum Ratings (Note 4)

Symbol	Parameter		Rating	Unit	
V _{DD}	Supply Voltage: (Note 5)		16.5	V	
V _{ID}	Differential Input Voltage		±V _{DD}	V	
V _{IN}	Input Voltage Range (Note 5)		-0.2 to V _{DD} +0.2V	V	
I _{IN}	Input Current Range		±10	mA	
I _O	Output Current Range		±100	mA	
P _D	Power Dissipation (Note 6)		TLV271 SOT25	220 mW	mW
			TLV271 SO-8	396 mW	
			TLV272 SO-8	396 mW	
			TLV272 MSOP-8	300 mW	
T _A	Operating Temperature Range	C grade	0 to +70	°C	
		I grade	-40 to +125		
T _J	Operating Junction Temperature		150	°C	
T _{ST}	Storage Temperature Range		-65 to +150	°C	
ESD HBM	Human Body Model ESD Protection (1.5kΩ in series with 100pF)		2	kV	
ESD MM	Machine Model ESD Protection		150	V	

- Notes:
- Stresses beyond those listed under absolute maximum ratings may cause permanent damage to the device. These are stress ratings only; functional operation of the device at these or any other conditions beyond those indicated under recommended operating conditions is not implied. Exposure to absolute-maximum-rated conditions for extended periods may affect device reliability.
 - All voltage values, except differential voltages, are with respect to ground
 - For operating at high temperatures, the TLV27x must be derated to zero based on a +150°C maximum junction temperature and a thermal resistance as below when the device is soldered to a printed circuit board, operating in a still air ambient:

Package	θ _{JA}	Unit
SOT25	180	°C/W
SO-8	150	
MSOP-8	155	

Recommended Operating Conditions

Symbol	Parameter		C grade		I grade		Unit
			Min	Max	Min	Max	
V _{DD}	Supply Voltage	Single Supply	2.7	16	2.7	16	V
		Split Supply	±1.35	±8	±1.35	±8	
V _{IC}	Common Mode Input Voltage		0	V _{DD} -1.35	0	V _{DD} -1.35	V
T _A	Operating Free Air Temperature		0	+70	-40	+125	°C

Electrical Characteristics (@ $T_A = +25^\circ\text{C}$ and $V_{DD} = 2.7\text{V}, 5\text{V}, \pm 5\text{V}$ unless otherwise specified.)

DC Performance								
Parameter		Conditions	T_A	Min	Typ	Max	Unit	
V_{IO}	Input Offset Voltage	$V_{IC} = V_{DD}/2, V_O = V_{DD}/2,$ $R_S = 50\Omega, R_L = 10k\Omega$	+25°C	—	0.5	5	mV	
			-40°C to +125°C	—	—	7		
α_{VIO}	Offset Voltage Drift		+25°C	—	6	—	$\mu\text{V}/^\circ\text{C}$	
A_{VD}	Large Signal Differential Voltage Gain	$V_{O(PP)} = V_{DD}/2, R_L = 10k\Omega$	$V_{DD} = 2.7\text{V}$	+25°C	97	106	dB	
				-40°C to +125°C	76	—		—
			$V_{DD} = 5\text{V}$	+25°C	100	110		—
				-40°C to +125°C	86	—		—
			$V_{DD} = \pm 5\text{V}$	+25°C	100	115		—
				-40°C to +125°C	90	—		—
CMRR	Common Mode Rejection Ratio	$V_{IC} = 0$ to $V_{DD} - 1.35\text{V},$ $R_S = 50\Omega$	$V_{DD} = 2.7\text{V}$	+25°C	58	70	dB	
				-40°C to +125°C	55	—		—
			$V_{DD} = 5\text{V}$	+25°C	65	80		—
				-40°C to +125°C	62	—		—
			$V_{DD} = \pm 5\text{V}$	+25°C	69	85		—
				-40°C to +125°C	66	—		—
Input Characteristics								
Parameter		Conditions	T_A	Min	Typ	Max	Unit	
I_{IO}	Input Offset Current	$V_{DD} = 5\text{V}, V_{IC} = V_{DD}/2,$ $V_O = V_{DD}/2, R_S = 50\Omega$	+25°C	—	1	60	pA	
			+70°C	—	—	100		
			+125°C	—	—	1000		
I_{IB}	Input Bias Current		+25°C	—	1	60		
			+70°C	—	—	100		
			+125°C	—	—	1000		
$r_{i(d)}$	Differential Input Resistance	—	+25°C	—	100	—	M Ω	
C_{IC}	Common Mode Input Capacitance	$f = 21\text{kHz}$	+25°C	—	12	—	pF	

NEW PRODUCT

Electrical Characteristics (cont.) (@ $T_A = +25^\circ\text{C}$ and $V_{DD} = 2.7\text{V}, 5\text{V}, \pm 5\text{V}$ unless otherwise specified.)

Output Characteristics								
Parameter		Conditions		T_A	Min	Typ	Max	Unit
V_{OH}	High Level Output Voltage	$V_{IC} = V_{DD}/2,$ $I_{OH} = -1\text{mA}$	$V_{DD} = 2.7\text{V}$	+25°C	2.55	2.58	—	V
				-40°C to +125°C	2.48	—	—	
			$V_{DD} = 5\text{V}$	+25°C	4.9	4.93	—	
				-40°C to +125°C	4.85	—	—	
			$V_{DD} = \pm 5\text{V}$	+25°C	4.92	4.96	—	
				-40°C to +125°C	4.9	—	—	
		$V_{IC} = V_{DD}/2,$ $I_{OH} = -5\text{mA}$	$V_{DD} = 2.7\text{V}$	+25°C	1.9	2.1	—	
				-40°C to +125°C	1.5	—	—	
			$V_{DD} = 5\text{V}$	+25°C	4.6	4.68	—	
				-40°C to +125°C	4.5	—	—	
			$V_{DD} = \pm 5\text{V}$	+25°C	4.7	4.84	—	
				-40°C to +125°C	4.65	—	—	
V_{OL}	Low Level Output Voltage	$V_{IC} = V_{DD}/2,$ $I_{OL} = 1\text{mA}$	$V_{DD} = 2.7\text{V}$	+25°C	—	0.1	0.15	V
				-40°C to +125°C	—	—	0.22	
			$V_{DD} = 5\text{V}$	+25°C	—	0.05	0.1	
				-40°C to +125°C	—	—	0.15	
			$V_{DD} = \pm 5\text{V}$	+25°C	—	-4.95	-4.92	
				-40°C to +125°C	—	—	-4.9	
		$V_{IC} = V_{DD}/2,$ $I_{OL} = 5\text{mA}$	$V_{DD} = 2.7\text{V}$	+25°C	—	0.5	0.7	
				-40°C to +125°C	—	—	1.1	
			$V_{DD} = 5\text{V}$	+25°C	—	0.28	0.4	
				-40°C to +125°C	—	—	0.5	
			$V_{DD} = \pm 5\text{V}$	+25°C	—	-4.84	-4.7	
				-40°C to +125°C	—	—	-4.65	
I_O	Output Current	$V_O = 0.5\text{V}$ from rail, $V_{DD} = 2.7\text{V}$	Positive rail	+25°C	—	4	—	mA
			Negative rail	+25°C	—	5	—	
		$V_O = 0.5\text{V}$ from rail, $V_{DD} = 5\text{V}$	Positive rail	+25°C	—	7	—	
			Negative rail	+25°C	—	8	—	
		$V_O = 0.5\text{V}$ from rail, $V_{DD} = 10\text{V}$	Positive rail	+25°C	—	13	—	
			Negative rail	+25°C	—	12	—	
Power Supply								
Parameter		Conditions		T_A	Min	Typ	Max	Unit
I_{DD}	Supply Current (per op-amp)	$V_O = V_{DD}/2$	$V_{DD} = 2.7\text{V}$	+25°C	—	470	560	μA
			$V_{DD} = 5\text{V}$	+25°C	—	550	660	
			$V_{DD} = 10\text{V}$	+25°C	—	625	800	
				-40°C to +125°C	—	—	1000	
I_{IB}	Power Supply Rejection Ratio ($\Delta V_{DD}/\Delta V_{IO}$)	$V_{DD} = 2.7\text{V}$ to 16V, $V_{IC} = V_{DD}/2$, No load	+25°C	70	80	—	dB	
			-40°C to +125°C	65	—	—		

NEW PRODUCT

Electrical Characteristics (cont.) (@ $T_A = +25^\circ\text{C}$ and $V_{DD} = 2.7\text{V}, 5\text{V}, \pm 5\text{V}$ unless otherwise specified.)

Dynamic Performance								
Parameter		Conditions		T_A	Min	Typ	Max	Unit
UGBW	Unity Gain Bandwidth	$R_L = 2\text{k}\Omega$, $C_L = 10\text{pF}$	$V_{DD} = 2.7\text{V}$	$+25^\circ\text{C}$	—	1.7	—	MHz
			$V_{DD} = 5\text{V to } 10\text{V}$	$+25^\circ\text{C}$	—	1.9	—	
SR	Slew Rate At Unity Gain	$V_{O(PP)} = V_{DD}/2$, $C_L = 50\text{pF}$, $R_L = 10\text{k}\Omega$	$V_{DD} = 2.7\text{V}$	$+25^\circ\text{C}$	1.2	2.1	—	V/ μs
				$-40^\circ\text{C to } +125^\circ\text{C}$	1	—	—	
			$V_{DD} = 5\text{V}$	$+25^\circ\text{C}$	1.25	2.0	—	
				$-40^\circ\text{C to } +125^\circ\text{C}$	1.05	—	—	
$V_{DD} = 10\text{V}$	$+25^\circ\text{C}$	1.3	2.2	—				
	$-40^\circ\text{C to } +125^\circ\text{C}$	1.1	—	—				
Φ_m	Phase Margin	$R_L = 2\text{k}\Omega, C_L = 10\text{pF}$		$+25^\circ\text{C}$	—	65°C	—	—
	Gain Margin	$R_L = 2\text{k}\Omega, C_L = 10\text{pF}$		$+25^\circ\text{C}$	—	12	—	dB
t_s	Settling Time	$V_{DD} = 2.7\text{V}$, $V_{(\text{STEP})PP} = 1\text{V}$, $A_V = -1, C_L = 10\text{pF}$, $R_L = 2\text{k}\Omega$	0.1%	$+25^\circ\text{C}$	—	2.9	—	μs
			$V_{DD} = 5\text{V}, \pm 5\text{V}$ $V_{(\text{STEP})PP} = 1\text{V}$, $A_V = -1, C_L = 47\text{pF}$, $R_L = 2\text{k}\Omega$	0.1%	$+25^\circ\text{C}$	—	2	
Noise/Distortion Performance								
Parameter		Conditions		T_A	Min	Typ	Max	Unit
THD+N	Total Harmonic Distortion Plus Noise	$V_{DD} = 2.7\text{V}$, $V_{O(PP)} = V_{DD}/2$, $R_L = 2\text{k}\Omega, f = 10\text{kHz}$	$A_V = 1$	$+25^\circ\text{C}$	—	0.02	—	%
			$A_V = 10$	$+25^\circ\text{C}$	—	0.05	—	
			$A_V = 100$	$+25^\circ\text{C}$	—	0.18	—	
		$V_{DD} = 5\text{V}, \pm 5\text{V}$ $V_{O(PP)} = V_{DD}/2$, $R_L = 2\text{k}\Omega, f = 10\text{kHz}$	$A_V = 1$	$+25^\circ\text{C}$	—	0.02	—	
			$A_V = 10$	$+25^\circ\text{C}$	—	0.09	—	
			$A_V = 100$	$+25^\circ\text{C}$	—	0.5	—	
V_n	Equivalent Input Noise Voltage	$f = 1\text{kHz}$		$+25^\circ\text{C}$	—	35	—	nV/ $\sqrt{\text{Hz}}$
		$f = 10\text{kHz}$		$+25^\circ\text{C}$	—	25	—	
I_n	Equivalent Input Noise Current	$f = 1\text{kHz}$		$+25^\circ\text{C}$	—	0.6	—	fA/ $\sqrt{\text{Hz}}$

Typical Performance Characteristics

List of Figures			
			Figure
V_{IO}	Input Offset Voltage	vs. free air temperature	1
$I_{B,IIO}$	Input Bias Current, Input Offset Current	vs. free air temperature	2
I_{DD}	Supply Current	vs. supply voltage	3
PSRR	Power Supply Rejection Ratio	vs. frequency	4
		vs. free air temperature	5
CMRR	Common Mode Rejection Ratio	vs. frequency	6
		vs. free air temperature	7
V_{OH}	High Level Output Voltage	vs. high level output current	8, 9, 10
V_{OL}	Low Level Output Voltage	vs. high level output current	11,12,13
SR	Slew Rate	vs. free air temperature	14
		vs. supply voltage	15
A_{VD}, Φ	Differential Voltage Gain And Phase	vs. frequency	16
Φ_m	Phase Margin	vs. capacitive load	17
—	Gain Bandwidth Product	vs. free air temperature	18
V_n	Equivalent Input Noise Voltage	vs. frequency	19
$V_{O(PP)}$	Peak To Peak Output Voltage	vs. frequency	20
—	Voltage Follower Large Signal Pulse Response	—	21, 22
—	Voltage Follower Small Signal Pulse Response	—	23
—	Inverting Large Signal Response	—	24, 25
—	Inverting Small Signal Response	—	26
—	Crosstalk	vs. frequency	27

Typical Performance Characteristics (cont.)

NEW PRODUCT

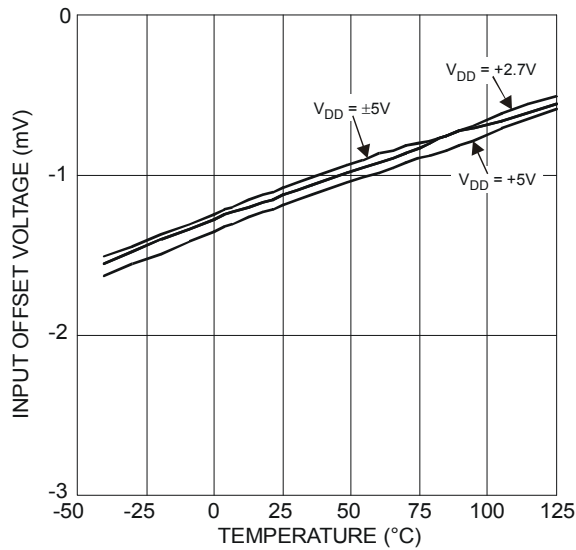

Figure 1 Input Offset Voltage vs. Temperature

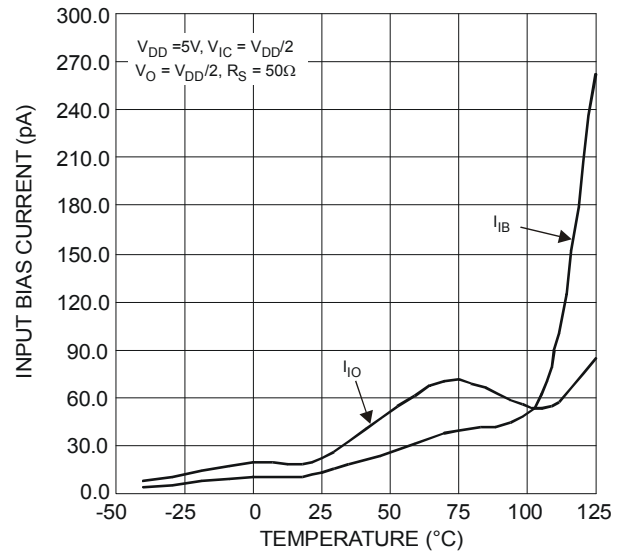

Figure 2 Input Bias and Offset Current vs. Temperature

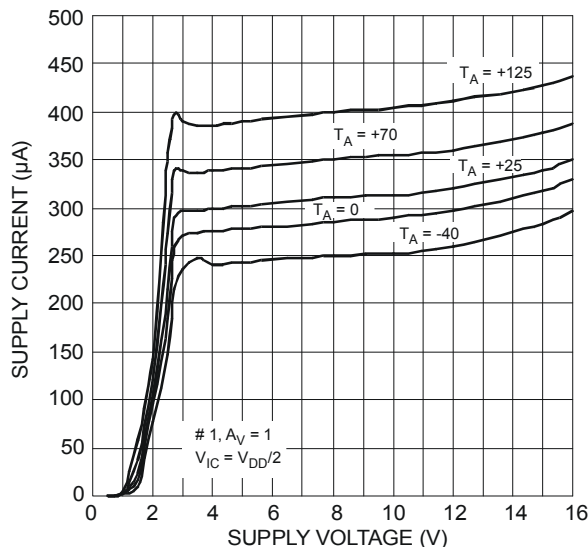

Figure 3 Supply Current vs. Supply Voltage

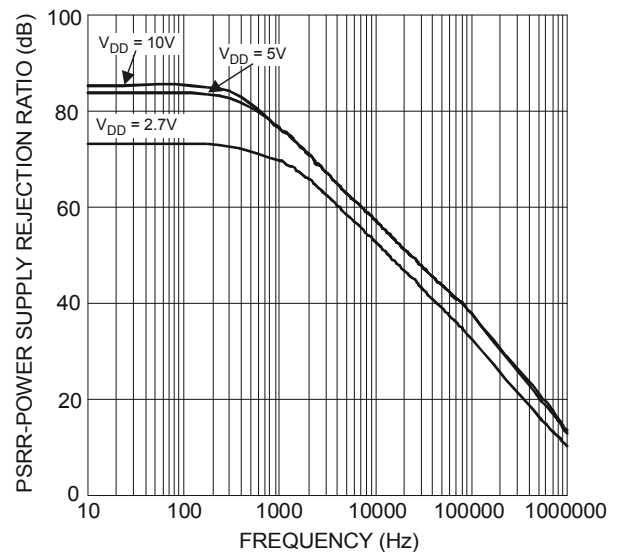

Figure 4 Power Supply Rejection Ratio vs. Frequency

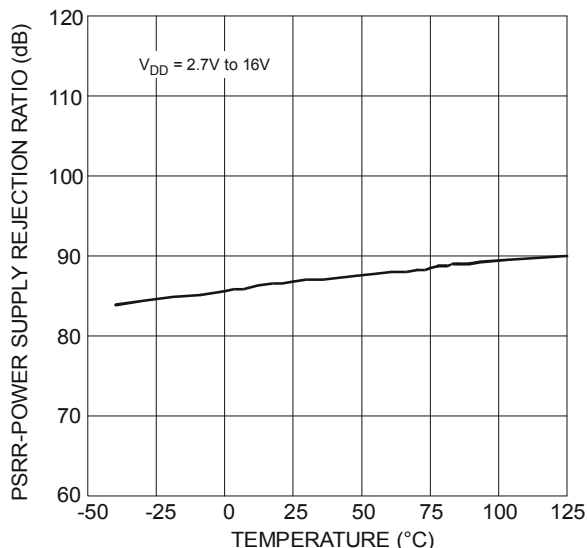

Figure 5 Power Supply Rejection Ratio vs. Temperature

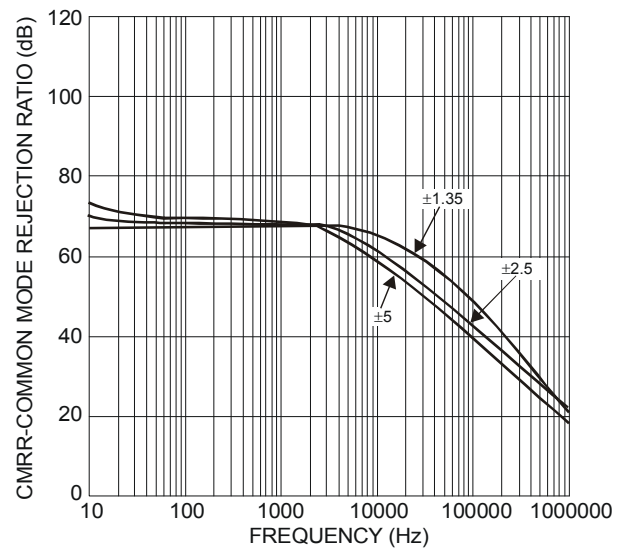

Figure 6 Common Mode Rejection Ratio vs. Frequency

Typical Performance Characteristics (cont.)

NEW PRODUCT

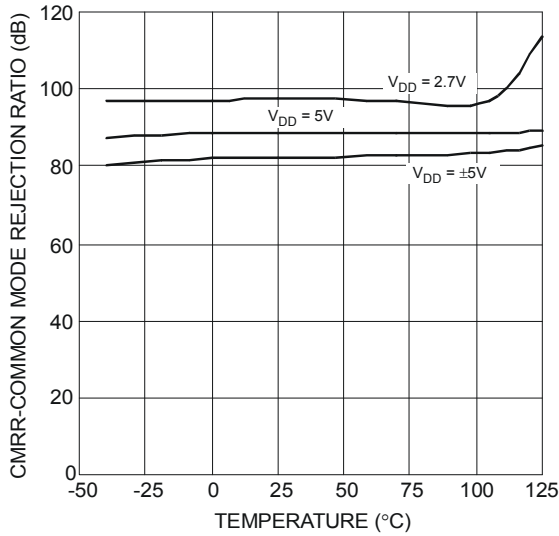

Figure 7 Common Mode Rejection Ratio vs. Temperature

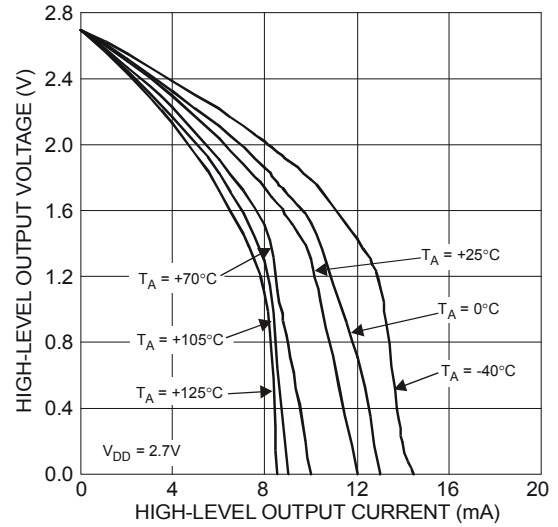

Figure 8 High-Level Output Voltage vs. High-Level Output Current

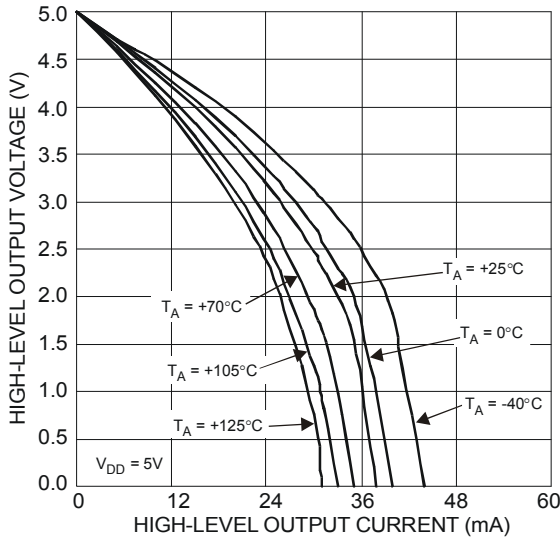

Figure 9 High-Level Output Voltage vs. High-Level Output Current

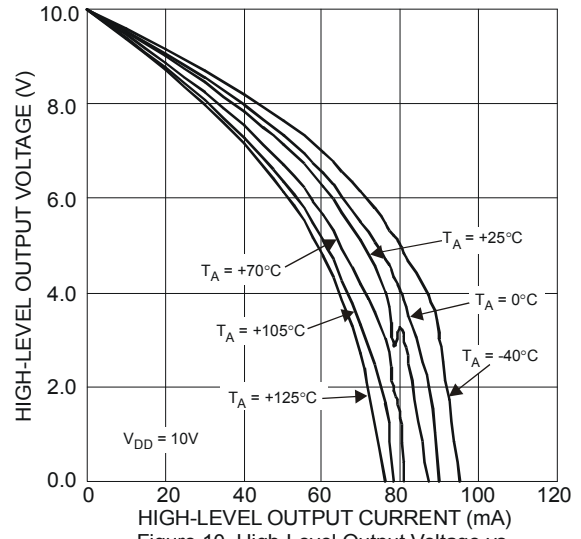

Figure 10 High-Level Output Voltage vs. High-Level Output Current

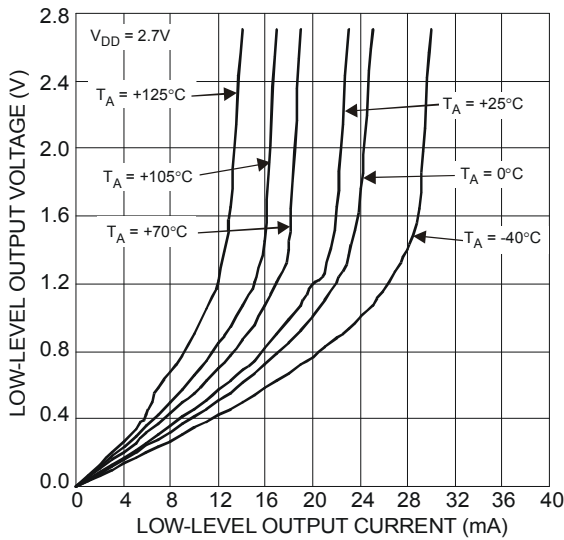

Figure 11 Low-Level Output Voltage vs. Low-Level Output Current

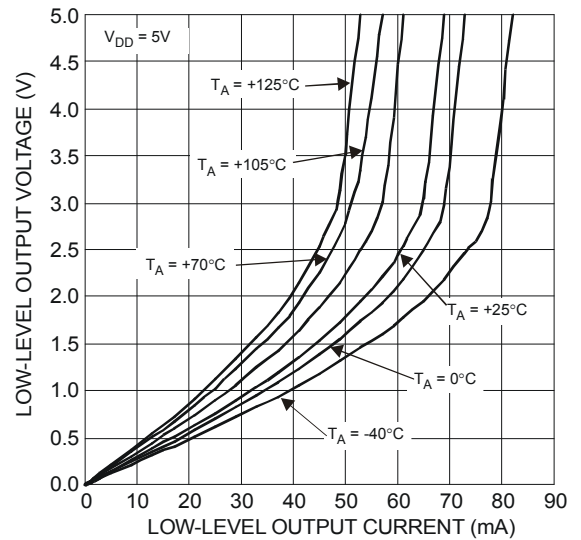

Figure 12 Low-Level Output Voltage vs. Low-Level Output Current

Typical Performance Characteristics (cont.)

NEW PRODUCT

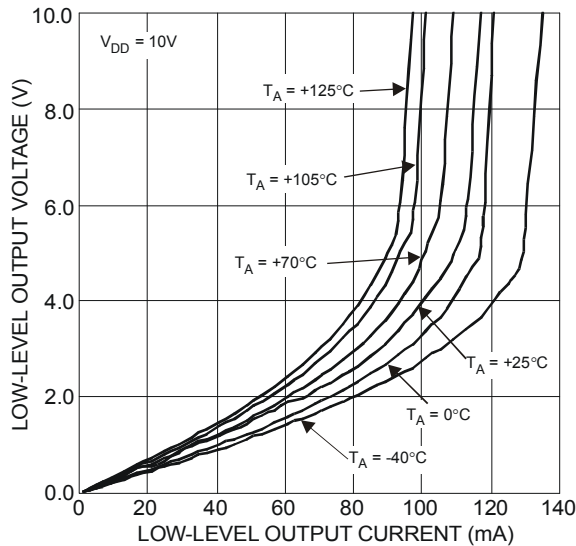

Figure 13 Low-Level Output Voltage vs. Low-Level Output Current

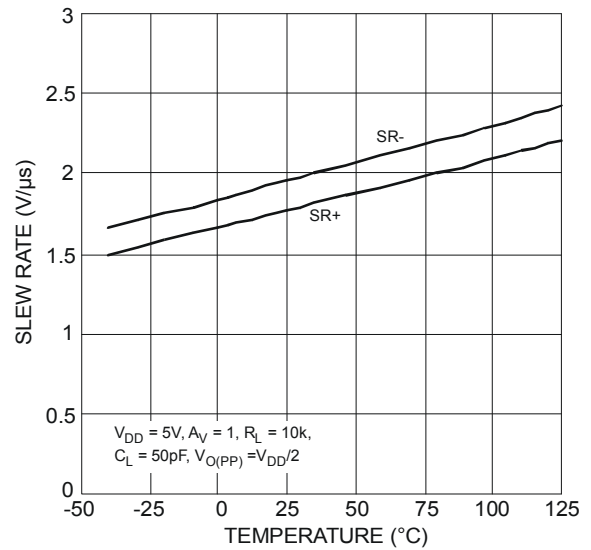

Figure 14 Slew Rate vs. Temperature

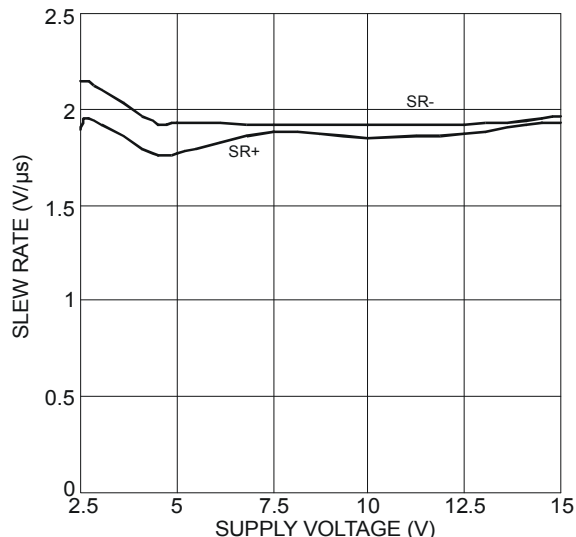

Figure 15 Slew Rate vs. Supply Voltage

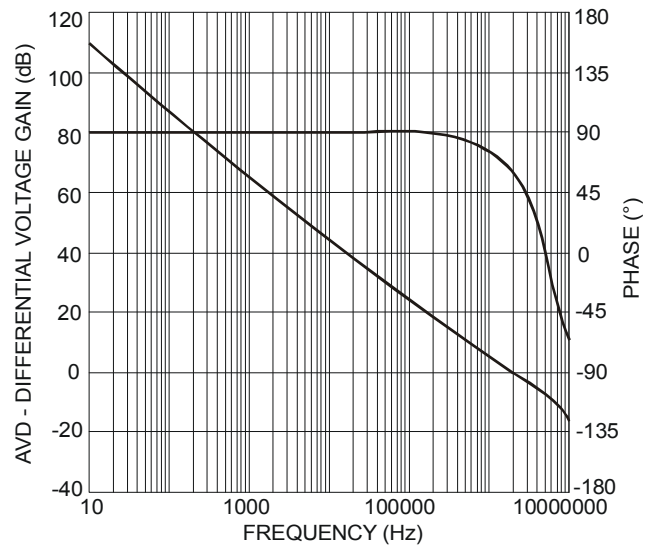

Figure 16 Differential Voltage Gain and Phase vs. Frequency

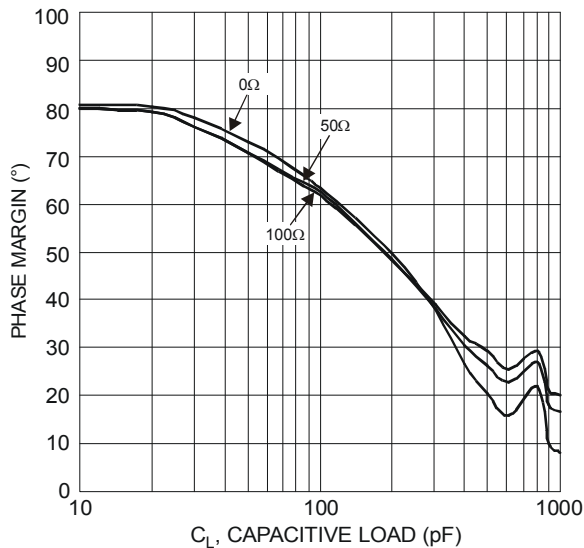

Figure 17 Phase Margin vs. Capacitive Load

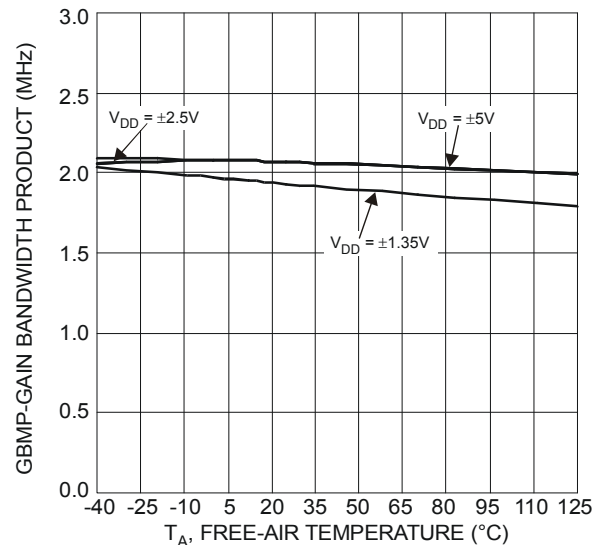

Figure 18 Gain Bandwidth Product vs. Free Air Temperature

Typical Performance Characteristics (cont.)

NEW PRODUCT

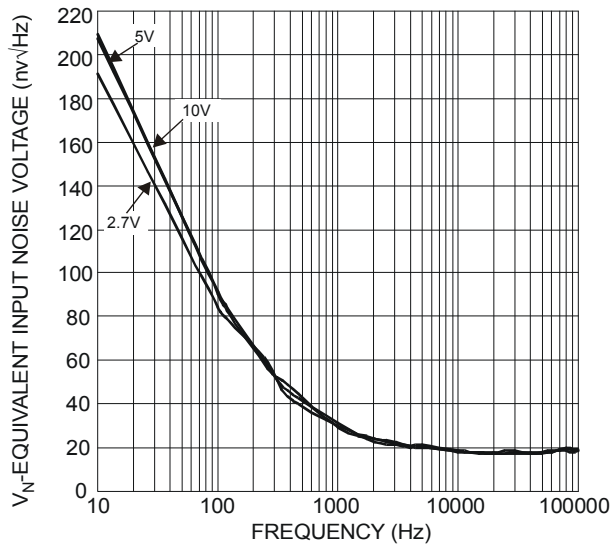

Figure 19 Equivalent Input Noise Voltage vs. Frequency

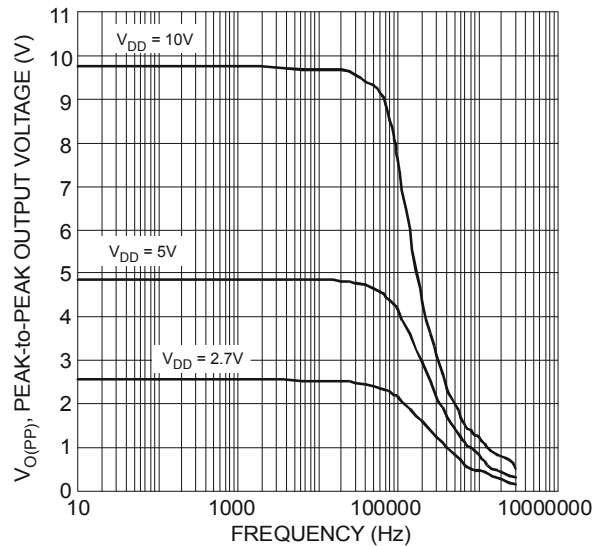

Figure 20 Peak-to-Peak Output Voltage vs. Frequency

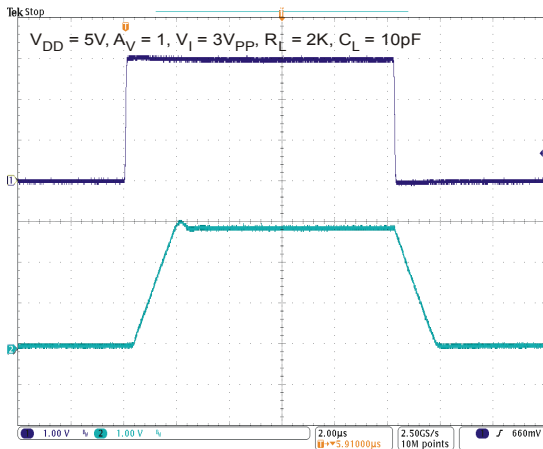

Figure 21 Voltage Follower Large Signal Pulse Response $V_{DD} = 5V$

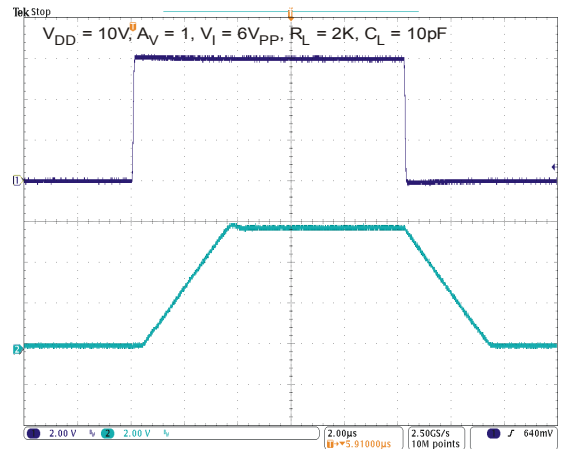

Figure 22 Voltage Follower Large Signal Pulse Response $V_{DD} = 10V$

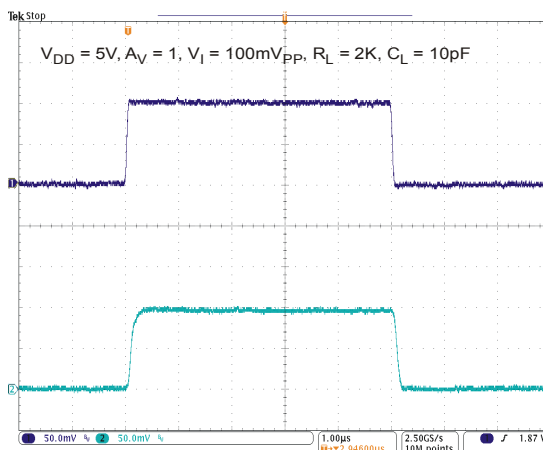

Figure 23 Voltage Follower Small Signal Pulse Response

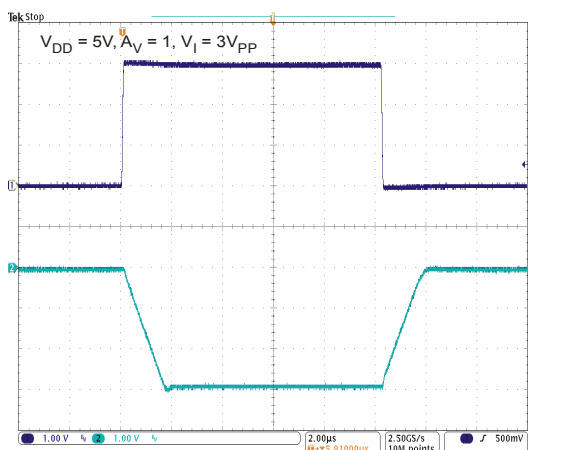

Figure 24 Inverting Large Signal Pulse Response $V_{DD} = 5V$

Typical Performance Characteristics (cont.)

NEW PRODUCT

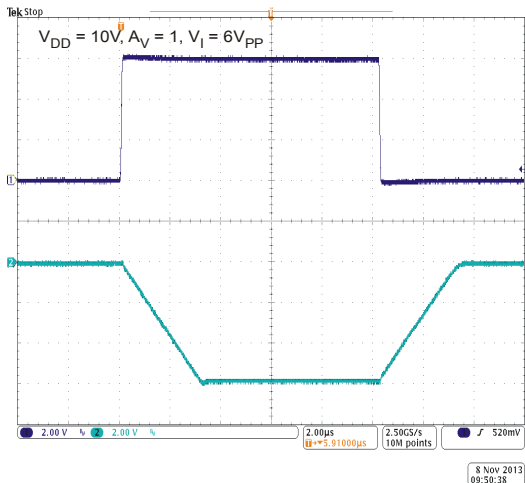

Figure 25 Inverting Large Signal Pulse Response $V_{DD} = 10V$

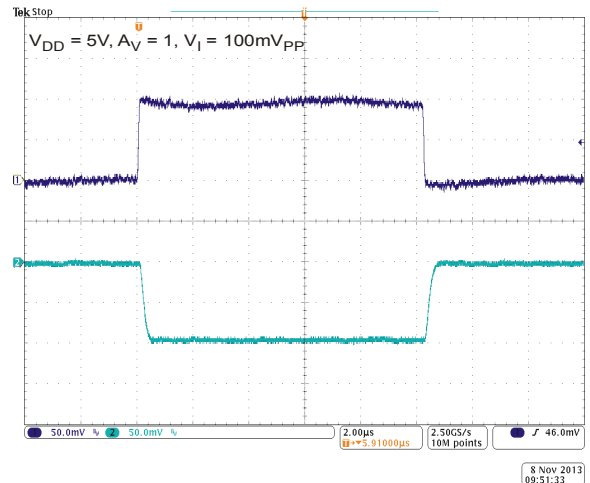

Figure 26 Inverting Small Signal Pulse Response

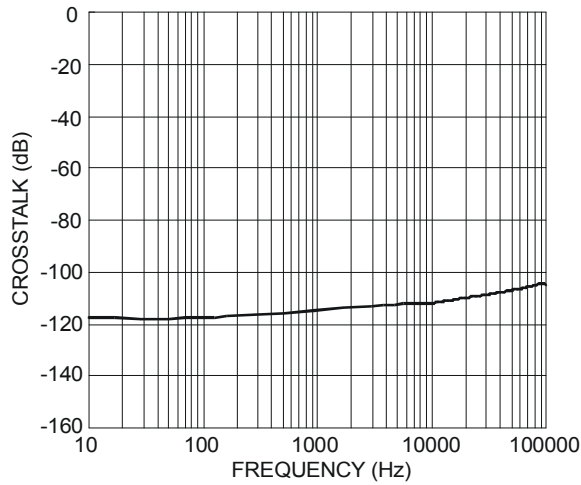

Figure 27 Crosstalk vs. Frequency TLV272

Application Information

Driving a Capacitive Load

When the amplifier is configured as below, capacitive loading directly on the output can decrease the device's phase margin leading to high frequency ringing or oscillations. Therefore, for capacitive loads of greater than 100pF, it is recommended that a resistor be placed in series (R_{NULL}) with the output of the amplifier, as shown in Figure 25. A minimum value of 20Ω should work well for most applications.

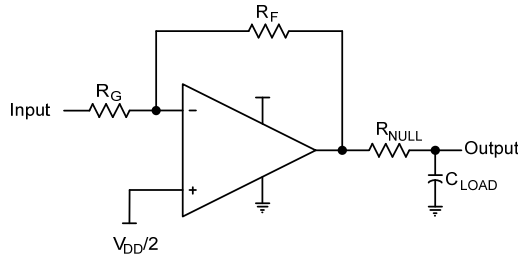

Figure 28 Driving a Capacitive Load

Offset Voltage

The output offset voltage, (V_{OO}) is the sum of the input offset voltage (V_{IO}) and both input bias currents (I_{IB}) times the corresponding gains. The following schematic and formula can be used to calculate the output offset voltage:

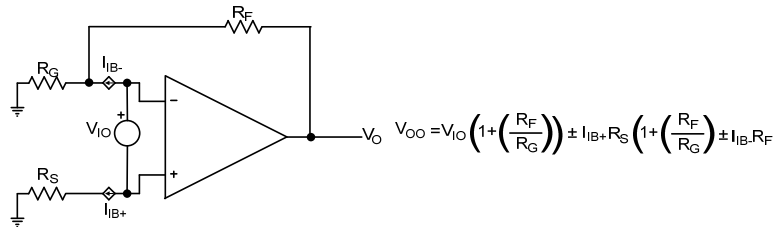

Figure 29 Output Offset Voltage Model

Other Configurations

When receiving low-level signals, limiting the bandwidth of the incoming signals into the system is often required. The simplest way to accomplish this is to place an RC filter at the non-inverting terminal of the amplifier (see Figure 30).

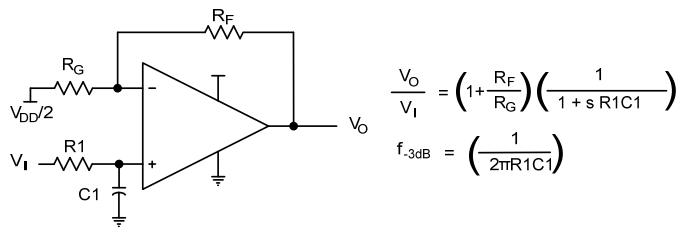

Figure 30. Single Pole Low Pass Filter

If even more attenuation is needed, a multiple pole filter is required. The Sallen-Key filter can be used for this task. For best results, the amplifier should have a bandwidth that is 8 to 10 times the filter frequency bandwidth. Failure to do this can result in phase shift of the amplifier.

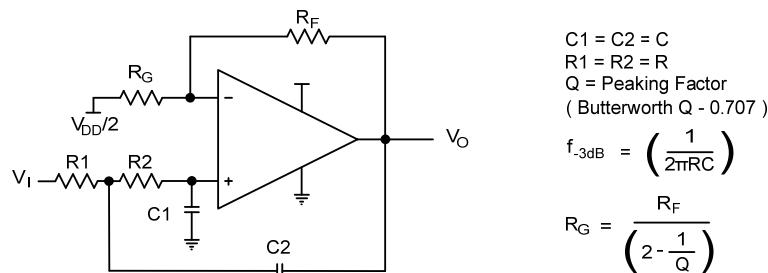

Figure 31. 2-Pole Low-Pass Sallen-Key Filter

Ordering Information

NEW PRODUCT

Part Number	Package Code	Operating Temperature Range	Packaging	7" or 13" Tape and Reel	
				Quantity	Part Number Suffix
TLV271CW5-7	W5	0 to +70°C	SOT25	3000/Tape & Reel	-7
TLV271CS-13	S	0 to +70°C	SO-8	2500/Tape & Reel	-13
TLV271IW5-7	W5	-40°C to +125°C	SOT25	3000/Tape & Reel	-7
TLV271IS-13	S	-40°C to +125°C	SO-8	2500/Tape & Reel	-13
TLV272CS-13	S	0 to +70°C	SO-8	2500/Tape & Reel	-13
TLV272CM8-13	M8	0 to +70°C	MSOP-8	2500/Tape & Reel	-13
TLV272IS-13*	S	-40°C to +125°C	SO-8	2500/Tape & Reel	-13
TLV272IM8-13	M8	-40°C to +125°C	MSOP-8	2500/Tape & Reel	-13

Marking Information

SOT25

Part mark	Part number
BV	TLV271CW5
BW	TLV271IW5

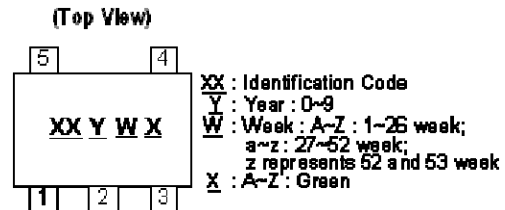

SO-8

Part mark	Part number
V271C	TLV271CS
V271I	TLV271IS
V272C	TLV272CS
V272I	TLV272IS

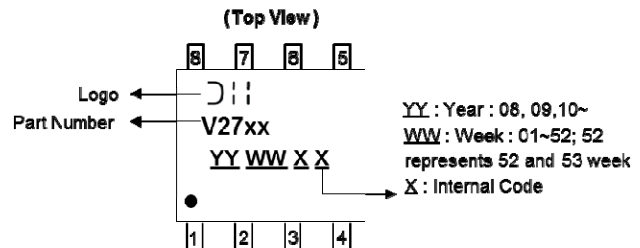

MSOP-8

Part mark	Part number
V272C	TLV272CM8
V272I	TLV272IM8

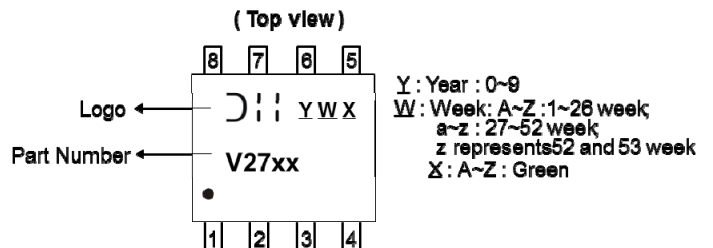

Package Outline Dimensions (All dimensions in mm.)

Please see AP02002 at <http://www.diodes.com/datasheets/ap02002.pdf> for latest version.

SOT25

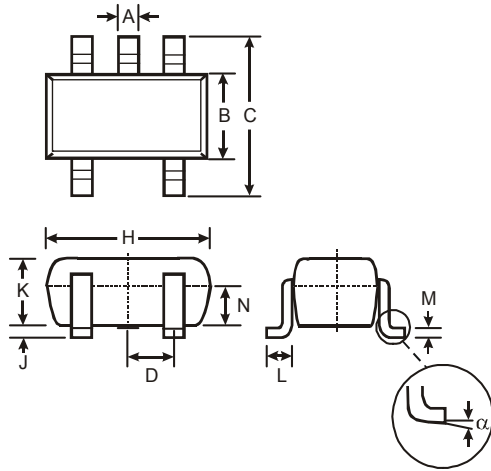

SOT25			
Dim	Min	Max	Typ
A	0.35	0.50	0.38
B	1.50	1.70	1.60
C	2.70	3.00	2.80
D	—	—	0.95
H	2.90	3.10	3.00
J	0.013	0.10	0.05
K	1.00	1.30	1.10
L	0.35	0.55	0.40
M	0.10	0.20	0.15
N	0.70	0.80	0.75
α	0°	8°	—
All Dimensions in mm			

SO-8

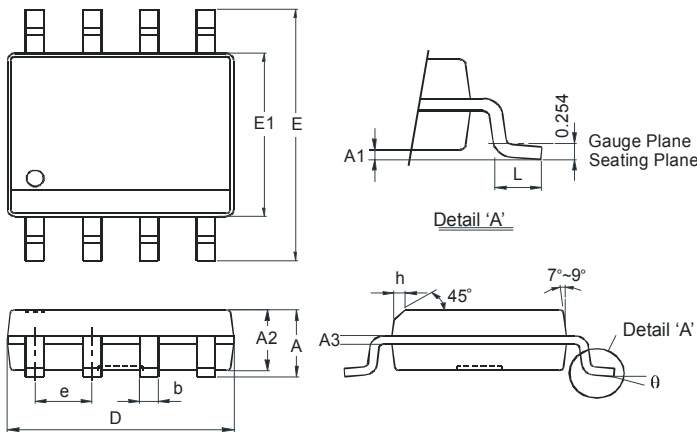

SO-8		
Dim	Min	Max
A	-	1.75
A1	0.10	0.20
A2	1.30	1.50
A3	0.15	0.25
b	0.3	0.5
D	4.85	4.95
E	5.90	6.10
E1	3.85	3.95
e	1.27 Typ	
h	-	0.35
L	0.62	0.82
θ	0°	8°
All Dimensions in mm		

MSOP-8

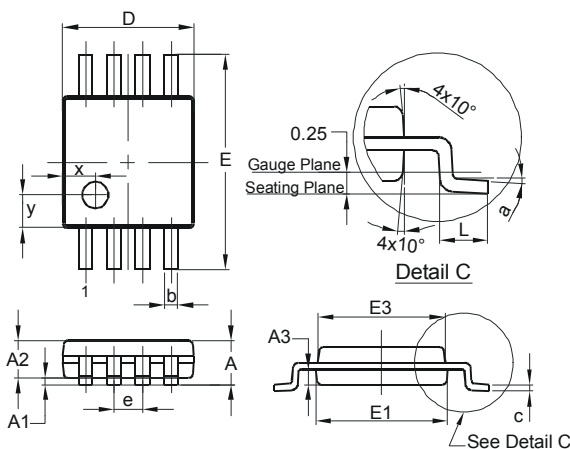

MSOP-8			
Dim	Min	Max	Typ
A	-	1.10	-
A1	0.05	0.15	0.10
A2	0.75	0.95	0.86
A3	0.29	0.49	0.39
b	0.22	0.38	0.30
c	0.08	0.23	0.15
D	2.90	3.10	3.00
E	4.70	5.10	4.90
E1	2.90	3.10	3.00
E3	2.85	3.05	2.95
e	-	-	0.65
L	0.40	0.80	0.60
a	0°	8°	4°
x	-	-	0.750
y	-	-	0.750
All Dimensions in mm			

NEW PRODUCT

Suggested Pad Layout

Please see AP02001 at <http://www.diodes.com/datasheets/ap02001.pdf> for the latest version.

SOT25

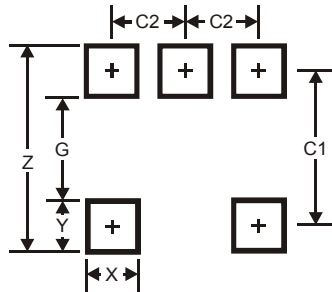

Dimensions	Value (in mm)
Z	3.20
G	1.60
X	0.55
Y	0.80
C1	2.40
C2	0.95

SO-8

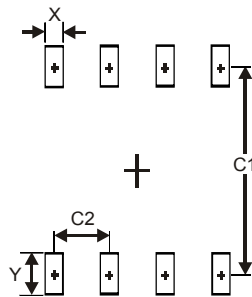

Dimensions	Value (in mm)
X	0.60
Y	1.55
C1	5.4
C2	1.27

MSOP-8

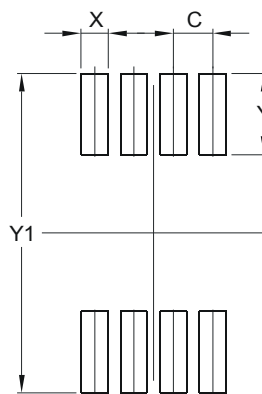

Dimensions	Value (in mm)
C	0.650
X	0.450
Y	1.350
Y1	5.300

NEW PRODUCT

IMPORTANT NOTICE

DIODES INCORPORATED MAKES NO WARRANTY OF ANY KIND, EXPRESS OR IMPLIED, WITH REGARDS TO THIS DOCUMENT, INCLUDING, BUT NOT LIMITED TO, THE IMPLIED WARRANTIES OF MERCHANTABILITY AND FITNESS FOR A PARTICULAR PURPOSE (AND THEIR EQUIVALENTS UNDER THE LAWS OF ANY JURISDICTION).

Diodes Incorporated and its subsidiaries reserve the right to make modifications, enhancements, improvements, corrections or other changes without further notice to this document and any product described herein. Diodes Incorporated does not assume any liability arising out of the application or use of this document or any product described herein; neither does Diodes Incorporated convey any license under its patent or trademark rights, nor the rights of others. Any Customer or user of this document or products described herein in such applications shall assume all risks of such use and will agree to hold Diodes Incorporated and all the companies whose products are represented on Diodes Incorporated website, harmless against all damages.

Diodes Incorporated does not warrant or accept any liability whatsoever in respect of any products purchased through unauthorized sales channel. Should Customers purchase or use Diodes Incorporated products for any unintended or unauthorized application, Customers shall indemnify and hold Diodes Incorporated and its representatives harmless against all claims, damages, expenses, and attorney fees arising out of, directly or indirectly, any claim of personal injury or death associated with such unintended or unauthorized application.

Products described herein may be covered by one or more United States, international or foreign patents pending. Product names and markings noted herein may also be covered by one or more United States, international or foreign trademarks.

This document is written in English but may be translated into multiple languages for reference. Only the English version of this document is the final and determinative format released by Diodes Incorporated.

LIFE SUPPORT

Diodes Incorporated products are specifically not authorized for use as critical components in life support devices or systems without the express written approval of the Chief Executive Officer of Diodes Incorporated. As used herein:

A. Life support devices or systems are devices or systems which:

1. are intended to implant into the body, or
2. support or sustain life and whose failure to perform when properly used in accordance with instructions for use provided in the labeling can be reasonably expected to result in significant injury to the user.

B. A critical component is any component in a life support device or system whose failure to perform can be reasonably expected to cause the failure of the life support device or to affect its safety or effectiveness.

Customers represent that they have all necessary expertise in the safety and regulatory ramifications of their life support devices or systems, and acknowledge and agree that they are solely responsible for all legal, regulatory and safety-related requirements concerning their products and any use of Diodes Incorporated products in such safety-critical, life support devices or systems, notwithstanding any devices- or systems-related information or support that may be provided by Diodes Incorporated. Further, Customers must fully indemnify Diodes Incorporated and its representatives against any damages arising out of the use of Diodes Incorporated products in such safety-critical, life support devices or systems.

Copyright © 2014, Diodes Incorporated

www.diodes.com