

0.5A to 6A, 250VAC EMI Filters

Features

- ◆ High Voltage Pulse Attenuation
- ◆ Lug or Wire Terminations
- ◆ Low Earth Leakage Current Option
- ◆ Conforms to UL, CSA and
- ◆ EN Safety Agency Certifications



Key Market Segments & Applications

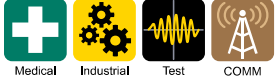

Specifications

Model	RSAL-20R5W					RSAL-2001W					RSAL-2002W					RSAL-2003W					RSAL-2006W							
	RSAL-20R5A					RSAL-2001A					RSAL-2002A					RSAL-2003A					RSAL-2006A							
Rated Voltage (AC, DC)		V		250V																								
Rated Current		A		0.5A					1A					2A					3A					6A				
Withstand Voltage		V		Terminals to Case: 2500VAC (1 Minute)																								
Isolation Resistance		MΩ		100MΩ minimum (500VDC, 1 Minute)																								
Leakage Current (max)		A		RSAL-20xxx 1mA; RSAL20xxxL 10uA (250VAC, 60Hz)																								
DC Resistance (total)		mΩ		700					600					250					150					80				
Operating Temperature		°C		-25 to +85°C (Derate above 55°C, see derating curve)																								
Storage Temperature		°C		-25 to +85°C																								
Safety Agency Certifications		-		UL1283, CSA C22.2 No.8, EN60939																								
Weight		g		61g Maximum																								
Warranty		yr		5 Year																								

Options

Wire Terminations	RSAL-20xxW
Lug Terminations	RSAL-20xxA
Wire Terminations & Low Leakage Current	RSAL-20xxWL
Lug Terminations & Low Leakage Current	RSAL-20xxAL

Derating

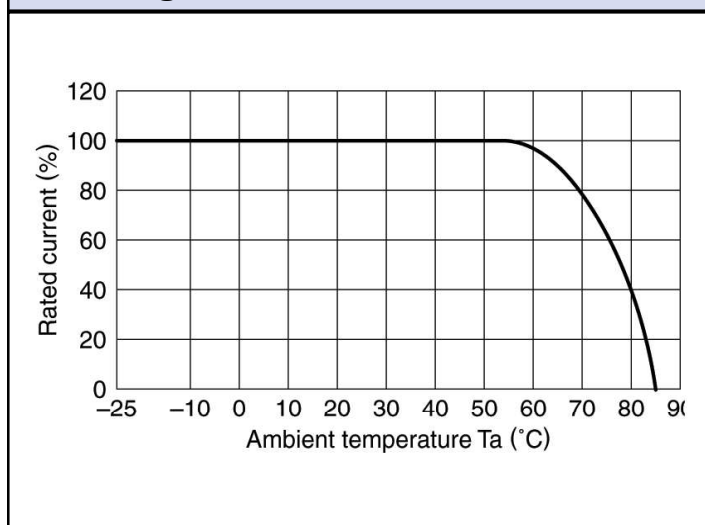

Outline Drawing

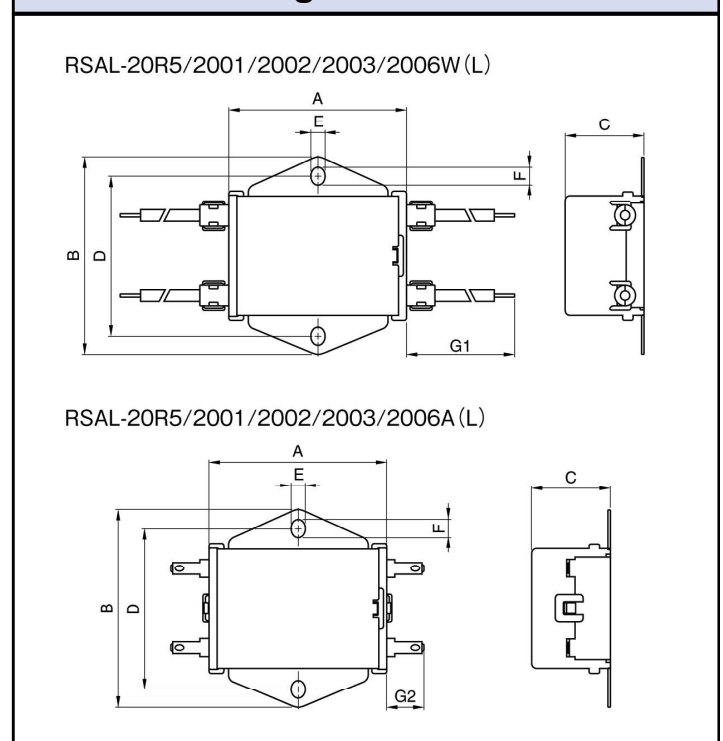

Circuit

RSAL-2 *** W
RSAL-2 *** A

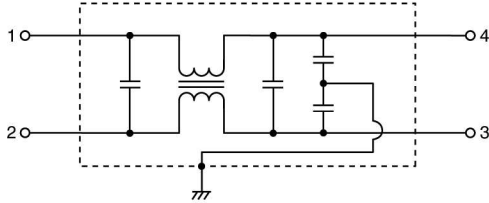

RSAL-2 *** WL
RSAL-2 *** AL

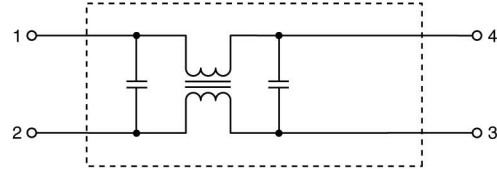

Attenuation Characteristics

RSAL-20R5W/A

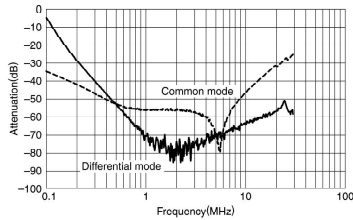

RSAL-2001W/A

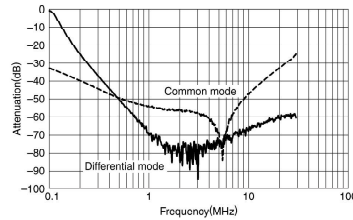

RSAL-2002W/A

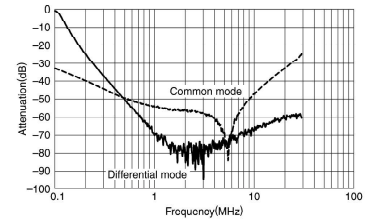

RSAL-2003W/A

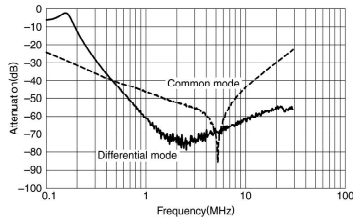

RSAL-2006W/A

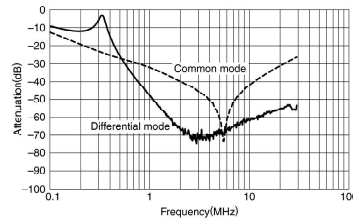

RSAL-20R5WL/AL

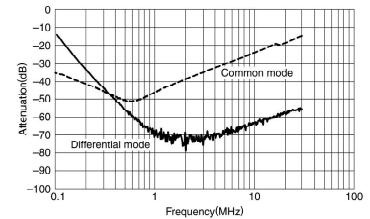

RSAL-2001WL/AL

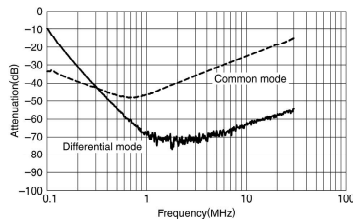

RSAL-2002WL/AL

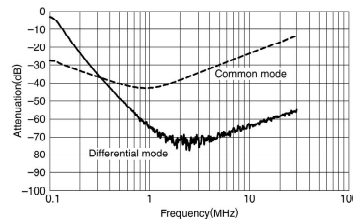

RSAL-2003WL/AL

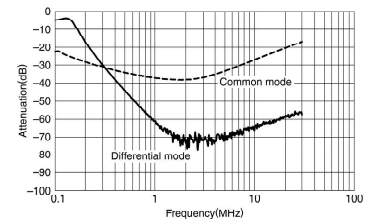

RSAL-2006WL/AL

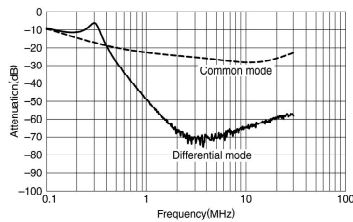

For Additional Information, please visit
us.tdk-lambda.com/lp/products/r-series.htm

