



## SinglFuse™ SF-1206HIxxxM Series Features

- Single blow fuse for overcurrent protection
- 3216 (EIA 1206) footprint
- High inrush current withstand fuse
- UL 248-14 listed
- RoHS compliant\* and halogen free\*\*
- Multilayer SMD design
- Surface mount packaging for automated assembly

### SF-1206HIxxxM Series - High Inrush Multilayer Surface Mount Fuses

#### Electrical Characteristics

Model	Rated Current (Amps)	Fusing Time	Resistance (Ω) Typ.***	Rated Voltage	Interrupting Rating	Typical I <sup>2</sup> t (A <sup>2</sup> s) ****
SF-1206HI100M-2	1.00	Open within 60 sec. at 200 % rated current	0.340	DC 63 V	DC 63 V 50 A	0.11
SF-1206HI150M-2	1.50		0.150			0.33
SF-1206HI200M-2	2.00		0.090			0.80
SF-1206HI250M-2	2.50		0.065	DC 32 V	DC 32 V 50 A	1.19
SF-1206HI300M-2	3.00		0.035			1.35
SF-1206HI350M-2	3.50		0.029			1.84
SF-1206HI400M-2	4.00		0.023			2.74
SF-1206HI450M-2	4.50		0.021			3.20
SF-1206HI500M-2	5.00		0.017			5.50
SF-1206HI600M-2	6.00		0.013	DC 24 V	DC 24 V 80 A	12.50
SF-1206HI700M-2	7.00		0.010			30.00
SF-1206HI800M-2	8.00		0.009			60.00

\*\*\* Resistance value measured with ≤10 % rated current at 25 °C ambient.

\*\*\*\* Melting I<sup>2</sup>t calculated at 1000 % of current rating.

#### Reliability Testing

No.	Test	Requirement	Test Condition	Test Reference
1	Solderability	Minimum 95 % coverage	One dip at 245 °C for 5 seconds	MIL-STD-202 Method 208
2	Soldering heat resistance	DCR change ≤ 10 % No mechanical damage	One dip at 260 °C for 60 seconds	MIL-STD-202 Method 210
3	Moisture resistance	DCR change ≤ ±15 % No excessive corrosion	10 cycles	MIL-STD-202 Method 106
4	Salt spray	DCR change ≤ ±10 % No excessive corrosion	48 hour exposure, 5 % salt solution	MIL-STD-202 Method 101
5	Mechanical vibration	DCR change ≤ ±10 % No mechanical damage	0.4 inch D.A. or 30 G between 5-3000 Hz	MIL-STD-202 Method 204
6	Mechanical shock	DCR change ≤ ±10 % No mechanical damage	1500 G, 0.5 ms, half-sine shocks	MIL-STD-202 Method 213
7	Thermal Shock	DCR change ≤ ±10 % No mechanical damage	100 cycles between -65 °C and +125 °C	MIL-STD-202 Method 107
8	Life	No electrical "opens" during testing Voltage drop change shall be less than ±20 % of initial value	80 % rated current (75 % for < 1 A fuses) for 2000 hours at ambient temperature between +20 °C and +30 °C	Refer to STP document

#### Agency Recognition

UL File Number ..... E198545

<http://www.ul.com/> Follow link to Online Certificates Directory, then enter UL File No. E198545, or [click here](#)

## BOURNS®

Asia-Pacific: Tel: +886-2 2562-4117 • Email: [asiacus@bourns.com](mailto:asiacus@bourns.com)

EMEA: Tel: +36 88 520 390 • Email: [eurocus@bourns.com](mailto:eurocus@bourns.com)

The Americas: Tel: +1-951 781-5500 • Email: [americus@bourns.com](mailto:americus@bourns.com)

[www.bourns.com](http://www.bourns.com)

\* RoHS Directive 2002/95/EC Jan. 27, 2003 including annex and RoHS Recast 2011/65/EU June 8, 2011.

\*\* Bourns considers a product to be "halogen free" if (a) the Bromine (Br) content is 900 ppm or less; (b) the Chlorine (Cl) content is 900 ppm or less; and (c) the total Bromine (Br) and Chlorine (Cl) content is 1500 ppm or less.

"SinglFuse" is a trademark of Bourns, Inc.

Specifications are subject to change without notice.

The device characteristics and parameters in this data sheet can and do vary in different applications and actual device performance may vary over time.

Users should verify actual device performance in their specific applications.

# SingIFuse™ SF-1206HlxxxM Series Applications

- Portable memory
  - LCD monitors
  - Disk drives
  - PDAs
  - Digital cameras
  - MP3 players
- Cell phones
  - Rechargeable battery packs
  - Battery chargers
  - Set-top boxes
  - Industrial controllers
  - Battery Management Systems (BMS)
- LED lighting
  - Power tools

## SF-1206HlxxxM Series - High Inrush Multilayer Surface Mount Fuses **BOURNS®**

### Environmental Characteristics

Operating Temperature.....	-55 °C to +150 °C
Storage Conditions	
Temperature .....	+5 °C to +35 °C
Humidity.....	40 % to 75 %
Shelf Life.....	2 years from manufacturing date
Moisture Sensitivity Level.....	1
ESD Classification (HBM).....	Class 6

### Typical Part Marking

Represents total content. Layout may vary.

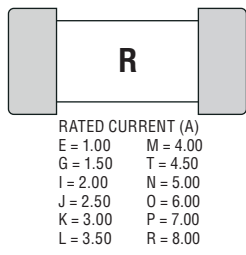

### How to Order

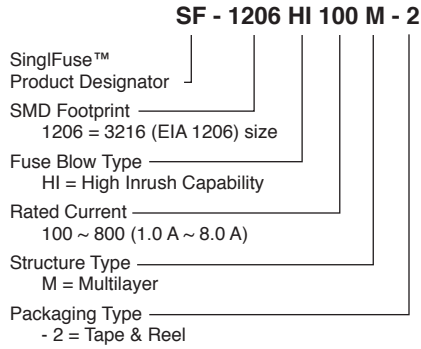

### Construction

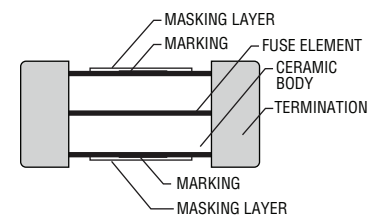

### Packaging Quantity

3,000 pieces per 7-inch reel

### Product Dimensions

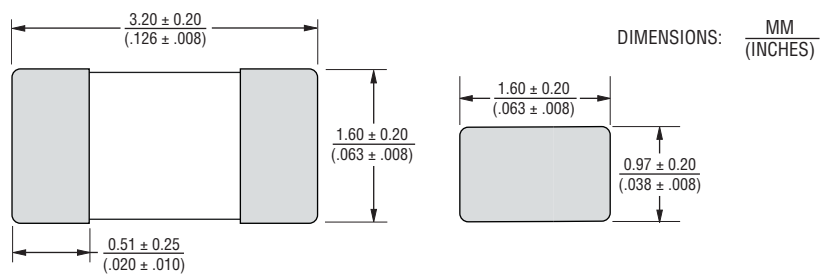

### Recommended Pad Layout

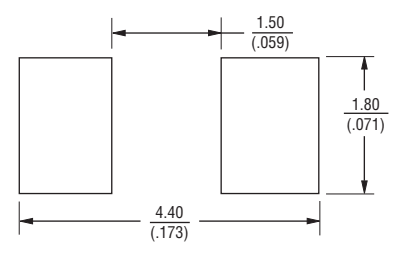

### Current Rating Thermal Derating Curve

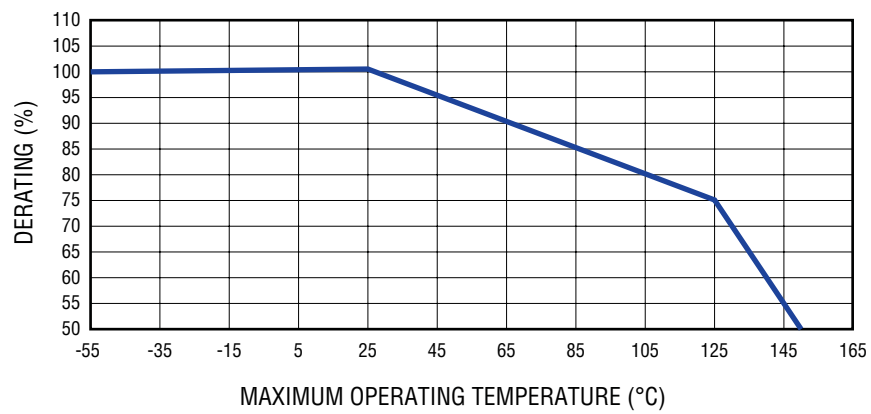

Specifications are subject to change without notice. The device characteristics and parameters in this data sheet can and do vary in different applications and actual device performance may vary over time. Users should verify actual device performance in their specific applications.

**Solder Reflow Recommendations**



Profile Feature	Pb-Free Assembly
Preheat / Soak: Temperature Min. ( $T_{smin}$ ) Temperature Max. ( $T_{smax}$ ) Time ( $t_s$ ) from ( $T_{smin}$ to $T_{smax}$ )	150 °C 200 °C 60~120 seconds
Ramp Up Rate ( $T_l$ to $T_d$ )	3 °C / second max.
Liquidous Temperature ( $T_l$ ) Time ( $t_L$ ) maintained above $T_l$	217 °C 60~150 seconds
Peak Package Body Temperature ( $T_d$ )	260 °C
Time ( $t_p$ )* within 5 °C of the specified classification temperature ( $T_c$ )	30 seconds*
Ramp Down Rate ( $T_d$ to $T_l$ )	6 °C / second max.
Time 25 °C to Peak Temperature	8 minutes max.

\* Tolerance for peak profile temperature ( $T_p$ ) is defined as a supplier minimum and a user maximum.

**Recommended Temperature Profile for Wave Soldering**



Wave soldering is suitable for 1206 size models.

Average Pre-Arcing Time vs. Current Curves



Average  $I^2t$  vs. t Curves



# SF-1206HlxxxM Series Tape and Reel Packaging Specifications

# BOURNS®

## SF-1206HlxxxM Series per EIA 481-2

### Tape Dimensions

W	$\frac{8.00 \pm 0.10}{(.315 \pm .004)}$
P <sub>0</sub>	$\frac{4.0 \pm 0.10}{(.157 \pm .004)}$
P <sub>1</sub>	$\frac{4.0 \pm 0.10}{(.157 \pm .004)}$
P <sub>2</sub>	$\frac{2.0 \pm 0.05}{(.079 \pm .002)}$
A <sub>0</sub>	$\frac{1.80 \pm 0.10}{(.071 \pm .004)}$
B <sub>0</sub>	$\frac{3.50 \pm 0.10}{(.138 \pm .004)}$
F	$\frac{3.50 \pm 0.05}{(.138 \pm .002)}$
E <sub>1</sub>	$\frac{1.75 \pm 0.10}{(.069 \pm .004)}$
D <sub>0</sub>	$\frac{1.50 \pm 0.10}{(.059 \pm .004)}$
K <sub>0</sub>	$\frac{1.10 \pm 0.10}{(.043 \pm .004)}$
T	$\frac{0.23 \pm 0.02}{(.009 \pm .001)}$

PACKAGING: Plastic tape, 3,000 pcs. per reel

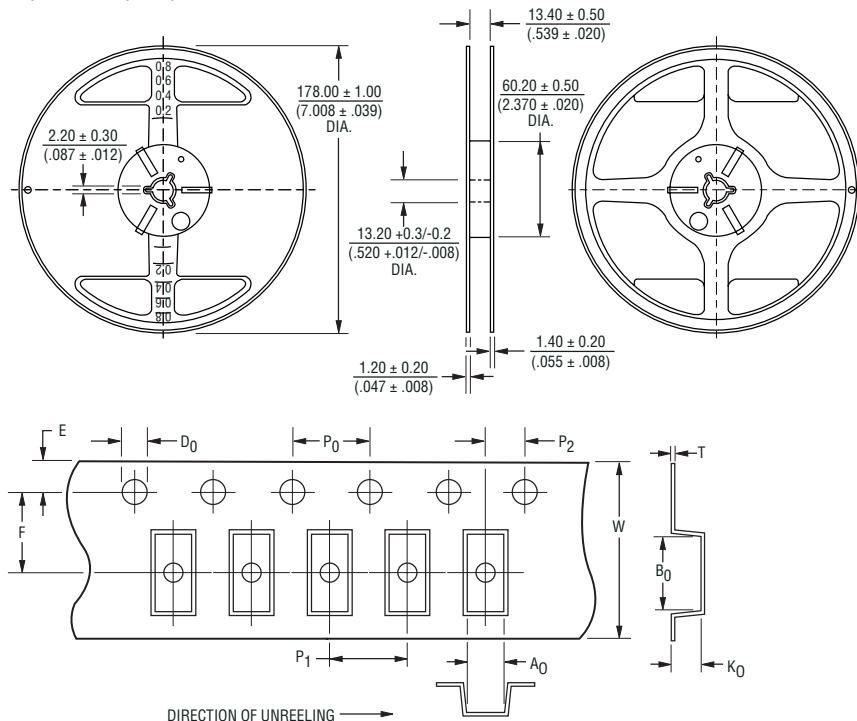

DIMENSIONS:  $\frac{\text{MM}}{(\text{INCHES})}$

Specifications are subject to change without notice.

The device characteristics and parameters in this data sheet can and do vary in different applications and actual device performance may vary over time. Users should verify actual device performance in their specific applications.