

LOC	DIST	REVISIONS			
P	LTR	DESCRIPTION	DATE	DWN	APVD
E	B	BA	NEW RELEASE	27-Sep-08	SM St.P

FOR FURTHER INFORMATION SEE DATA SHEET FOR
 CPF SERIES-THIN FILM PRECISION CHIP RESISTORS

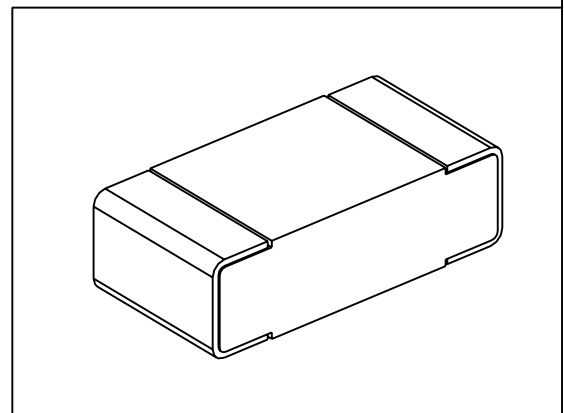

RoHS Compliant



2008

RELEASED FOR PUBLICATION

THIS DRAWING IS UNPUBLISHED.

BY TYCO ELECTRONICS CORPORATION. ALL RIGHTS RESERVED.



DIMENSIONS: mm	DWN SUBHASH.M	27-Sep-08	MATERIAL	-	FINISH	-
	CHK PRAKASH.S	27-Sep-08	Tyco Electronics Corporation Dorcan, Swindon, SN3 5HH			
TOLERANCES UNLESS OTHERWISE SPECIFIED:	APVD STEPHEN.P	27-Sep-08				
0 PLC ±0.2	PRODUCT SPEC	-	NAME THIN FILM PRECISION CHIP RESISTORS SERIES CPF 0402			
1 PLC ±0.1	APPLICATION SPEC	-				
2 PLC ±-	WEIGHT	-	SIZE	A 4	CAGE CODE	00779
3 PLC ±-			DRAWING NO	C= 1879215		RESTRICTED TO
4 PLC ±-						-
ANGLES ±5°						
	CUSTOMER DRAWING		SCALE	50:1	SHEET	1 OF 1
						REV BA