



Is Now Part of



ON Semiconductor®

To learn more about ON Semiconductor, please visit our website at
www.onsemi.com

Please note: As part of the Fairchild Semiconductor integration, some of the Fairchild orderable part numbers will need to change in order to meet ON Semiconductor's system requirements. Since the ON Semiconductor product management systems do not have the ability to manage part nomenclature that utilizes an underscore (_), the underscore (_) in the Fairchild part numbers will be changed to a dash (-). This document may contain device numbers with an underscore (_). Please check the ON Semiconductor website to verify the updated device numbers. The most current and up-to-date ordering information can be found at www.onsemi.com. Please email any questions regarding the system integration to Fairchild_questions@onsemi.com.

ON Semiconductor and the ON Semiconductor logo are trademarks of Semiconductor Components Industries, LLC dba ON Semiconductor or its subsidiaries in the United States and/or other countries. ON Semiconductor owns the rights to a number of patents, trademarks, copyrights, trade secrets, and other intellectual property. A listing of ON Semiconductor's product/patent coverage may be accessed at www.onsemi.com/site/pdf/Patent-Marking.pdf. ON Semiconductor reserves the right to make changes without further notice to any products herein. ON Semiconductor makes no warranty, representation or guarantee regarding the suitability of its products for any particular purpose, nor does ON Semiconductor assume any liability arising out of the application or use of any product or circuit, and specifically disclaims any and all liability, including without limitation special, consequential or incidental damages. Buyer is responsible for its products and applications using ON Semiconductor products, including compliance with all laws, regulations and safety requirements or standards, regardless of any support or applications information provided by ON Semiconductor. "Typical" parameters which may be provided in ON Semiconductor data sheets and/or specifications can and do vary in different applications and actual performance may vary over time. All operating parameters, including "Typicals" must be validated for each customer application by customer's technical experts. ON Semiconductor does not convey any license under its patent rights nor the rights of others. ON Semiconductor products are not designed, intended, or authorized for use as a critical component in life support systems or any FDA Class 3 medical devices or medical devices with a same or similar classification in a foreign jurisdiction or any devices intended for implantation in the human body. Should Buyer purchase or use ON Semiconductor products for any such unintended or unauthorized application, Buyer shall indemnify and hold ON Semiconductor and its officers, employees, subsidiaries, affiliates, and distributors harmless against all claims, costs, damages, and expenses, and reasonable attorney fees arising out of, directly or indirectly, any claim of personal injury or death associated with such unintended or unauthorized use, even if such claim alleges that ON Semiconductor was negligent regarding the design or manufacture of the part. ON Semiconductor is an Equal Opportunity/Affirmative Action Employer. This literature is subject to all applicable copyright laws and is not for resale in any manner.



August 2016

FAN7842 High- and Low-Side Gate Driver

Features

- Floating Channels Designed for Bootstrap Operation to +200 V
- Typically 350 mA/650 mA Sourcing/Sinking Current Driving Capability for Both Channels
- Common-Mode dv/dt Noise Canceling Circuit
- Extended Allowable Negative V_S Swing to -9.8 V for Signal Propagation at $V_{CC}=V_{BS}=15$ V
- V_{CC} & V_{BS} Supply Range from 10 V to 20 V
- UVLO Functions for Both Channels
- TTL Compatible Input Logic Threshold Levels
- Matched Propagation Delay Below 50 nsec
- Output In-phase with Input Signal

Applications

- Battery based motor applications (E-bike, Power Tool)
- Telecom DC-DC converter

Related Resources

- [AN-6076 - Design and Application Guide of Bootstrap Circuit for High-Voltage Gate-Drive IC](#)
- [AN-9052 - Design Guide for Selection of Bootstrap Components](#)
- [AN-8102 - Recommendations to Avoid Short Pulse Width Issues in HVIC Gate Driver Applications](#)

Description

The FAN7842, a monolithic high and low side gate drive IC, which can drive MOSFETs and IGBTs that operate up to +200 V.

Fairchild's high-voltage process and common-mode noise canceling technique provide stable operation of the high-side driver under high-dv/dt noise circumstances. An advanced level-shift circuit allows high-side gate driver operation up to $V_S=-9.8$ V (typical) for $V_{BS}=15$ V. The input logic level is compatible with standard TTL-series logic gates.

The UVLO circuits for both channels prevent malfunction when V_{CC} and V_{BS} are lower than the specified threshold voltage. Output driver current (source/sink) is typically 350mA/650mA, respectively.

8-SOP



Ordering Information

Part Number	Package	Operating Temperature Range	Packing Method
FAN7842MX ⁽¹⁾	8-SOP	-40°C ~ 125°C	Tape & Reel

Note:

1. These devices passed wave soldering test by JESD22A-111.

Typical Application Circuit

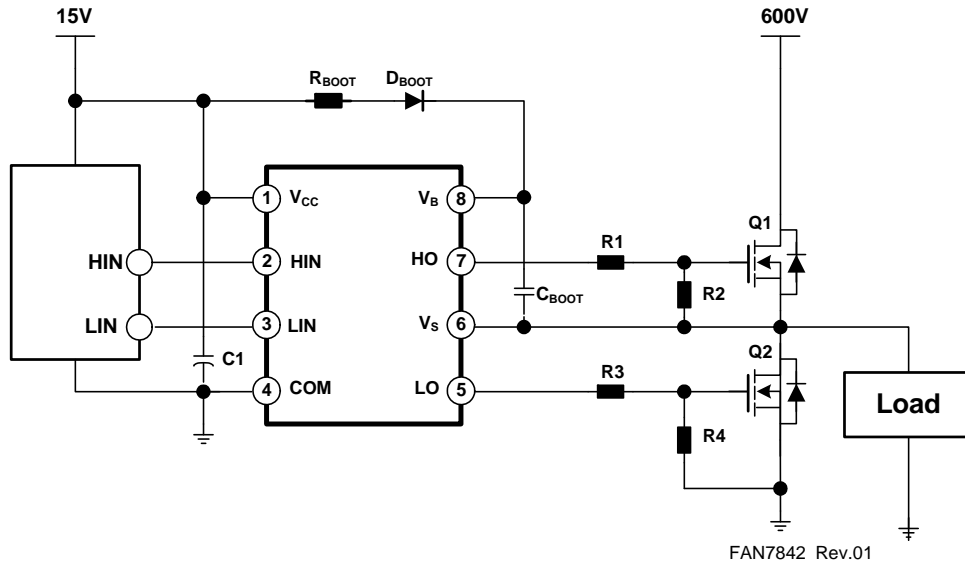

Figure 1. Application Circuit for Half-Bridge

Internal Block Diagram

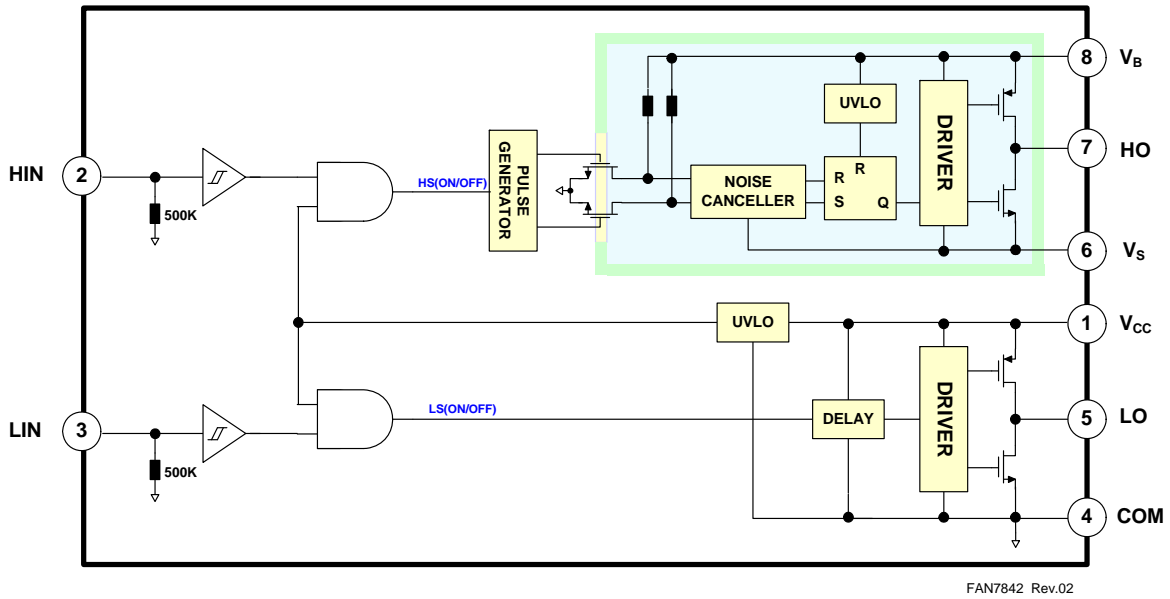

Figure 2. Functional Block Diagram

Pin Assignments

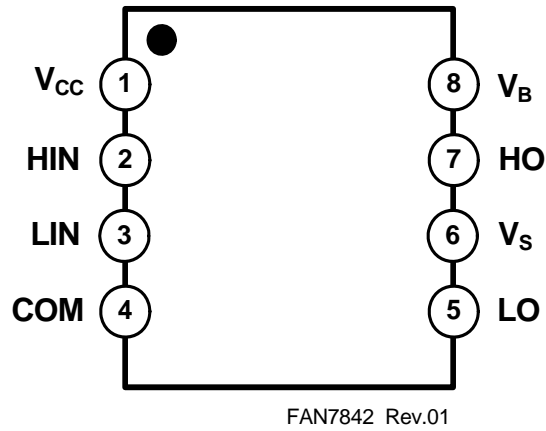

Figure 3. Pin Configuration (Top View)

Pin Definitions

Name	Description
V_{CC}	Low-Side Supply Voltage
HIN	Logic Input for High-Side Gate Driver Output
LIN	Logic Input for Low-Side Gate Driver Output
COM	Logic Ground and Low-Side Driver Return
LO	Low-Side Driver Output
V_S	High-Voltage Floating Supply Return
HO	High-Side Driver Output
V_B	High-Side Floating Supply

Absolute Maximum Ratings

Stresses exceeding the absolute maximum ratings may damage the device. The device may not function or be operable above the recommended operating conditions and stressing the parts to these levels is not recommended. In addition, extended exposure to stresses above the recommended operating conditions may affect device reliability. The absolute maximum ratings are stress ratings only.

Symbol	Characteristics	Min.	Max.	Unit
V_S	High-side offset voltage	V_B-25	$V_B+0.3$	V
V_B	High-side floating supply voltage	-0.3	225	
V_{HO}	High-side floating output voltage HO	$V_S-0.3$	$V_B+0.3$	
V_{CC}	Low-side and logic fixed supply voltage	-0.3	25	
V_{LO}	Low-side output voltage LO	-0.3	$V_{CC}+0.3$	
V_{IN}	Logic input voltage (HIN, LIN)	-0.3	$V_{CC}+0.3$	
COM	Logic ground	$V_{CC}-25$	$V_{CC}+0.3$	
dV_S/dt	Allowable offset voltage slew rate		50	
$P_D^{(2)(3)(4)}$	Power dissipation		0.625	W
θ_{JA}	Thermal resistance, junction-to-ambient		200	°C/W
T_J	Junction temperature		150	°C
T_{STG}	Storage temperature		150	°C

Notes:

- Mounted on 76.2 x 114.3 x 1.6 mm PCB (FR-4 glass epoxy material).
- Refer to the following standards:
 - JESD51-2: Integral circuits thermal test method environmental conditions - natural convection
 - JESD51-3: Low effective thermal conductivity test board for leaded surface mount packages
- Do not exceed P_D under any circumstances.

Recommended Operating Ratings

The Recommended Operating Conditions table defines the conditions for actual device operation. Recommended operating conditions are specified to ensure optimal performance to the datasheet specifications. Fairchild does not recommend exceeding them or designing to Absolute Maximum Ratings.

Symbol	Parameter	Min.	Max.	Unit
V_B	High-side floating supply voltage	V_S+10	V_S+20	V
V_S	High-side floating supply offset voltage	$6-V_{CC}$	200	
V_{HO}	High-side (HO) output voltage	V_S	V_B	
V_{LO}	Low-side (LO) output voltage	COM	V_{CC}	
V_{IN}	Logic input voltage (HIN, LIN)	COM	V_{CC}	
V_{CC}	Low-side supply voltage	10	20	
T_A	Ambient temperature	-40	125	

Electrical Characteristics

V_{BIAS} (V_{CC} , V_{BS})=15.0 V, $T_A = 25^\circ\text{C}$, unless otherwise specified. The V_{IN} and I_{IN} parameters are referenced to COM. The V_O and I_O parameters are referenced to V_S and COM and are applicable to the respective outputs HO and LO.

Symbol	Characteristics	Test Condition	Min.	Typ.	Max.	Unit
V_{CCUV+} V_{BSUV+}	V_{CC} and V_{BS} supply under-voltage positive going threshold		8.2	9.2	10.0	V
V_{CCUV-} V_{BSUV-}	V_{CC} and V_{BS} supply under-voltage negative going threshold		7.6	8.7	9.6	
V_{CCUVH} V_{BSUVH}	V_{CC} supply under-voltage lockout hysteresis			0.6		
I_{LK}	Offset supply leakage current	$V_B=V_S=200\text{ V}$			50	μA
I_{QBS}	Quiescent V_{BS} supply current	$V_{IN}=0\text{ V}$ or 5 V		45	120	
I_{QCC}	Quiescent V_{CC} supply current	$V_{IN}=0\text{ V}$ or 5 V		70	180	
I_{PBS}	Operating V_{BS} supply current	$f_{IN}=20\text{ kHz}$, rms value			600	μA
I_{PCC}	Operating V_{CC} supply current	$f_{IN}=20\text{ kHz}$, rms value			600	
V_{IH}	Logic "1" input voltage		2.9			V
V_{IL}	Logic "0" input voltage				0.8	
V_{OH}	High-level output voltage, $V_{BIAS}-V_O$	$I_O=20\text{ mA}$			1.0	
V_{OL}	Low-level output voltage, V_O				0.6	
I_{IN+}	Logic "1" input bias current	$V_{IN}=5\text{ V}$		10	20	μA
I_{IN-}	Logic "0" input bias current	$V_{IN}=0\text{ V}$		1.0	2.0	
I_{O+}	Output high short-circuit pulsed current	$V_O=0\text{ V}$, $V_{IN}=5\text{ V}$ with $PW<10\text{ }\mu\text{s}$	250	350		mA
I_{O-}	Output low short-circuit pulsed current	$V_O=15\text{ V}$, $V_{IN}=0\text{ V}$ with $PW<10\text{ }\mu\text{s}$	500	650		
V_S	Allowable negative V_S pin voltage for HIN signal propagation to HO			-9.8	-7.0	V

Dynamic Electrical Characteristics

V_{BIAS} (V_{CC} , V_{BS})=15.0 V, $V_S=COM$, $C_L=1000\text{ pF}$ and, $T_A = 25^\circ\text{C}$, unless otherwise specified.

Symbol	Characteristics	Test Condition	Min.	Typ.	Max.	Unit
t_{on}	Turn-on propagation delay	$V_S=0\text{ V}$	100	170	300	ns
t_{off}	Turn-off propagation delay	$V_S=0\text{ V}$ or $200\text{ V}^{(5)}$	100	200	300	
t_r	Turn-on rise time		20	60	140	
t_f	Turn-off fall time			30	80	
MT	Delay matching, HS & LS turn-on/off				50	

Note:

5. This parameter guaranteed by design.

Typical Characteristics

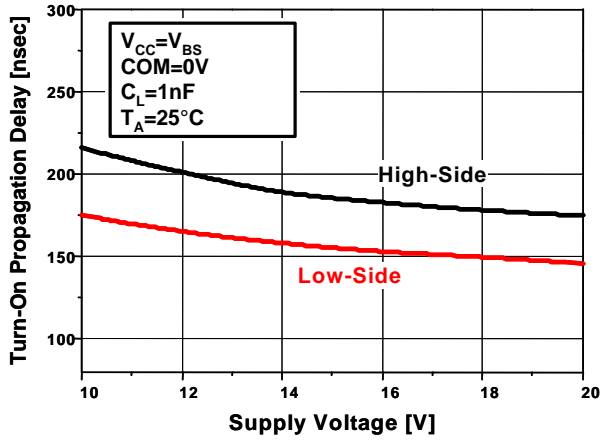

Figure 4. Turn-On Propagation Delay vs. Supply Voltage

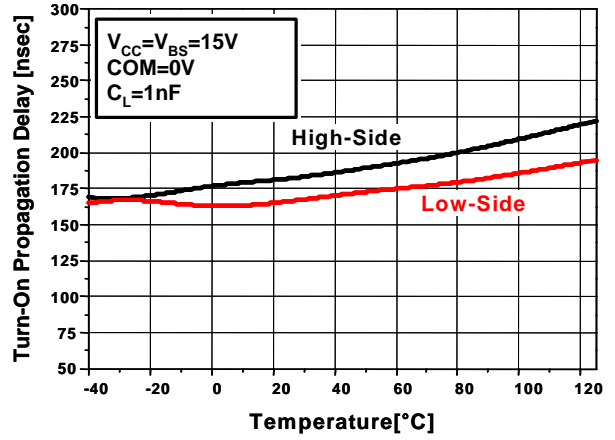

Figure 5. Turn-On Propagation Delay vs. Temp.

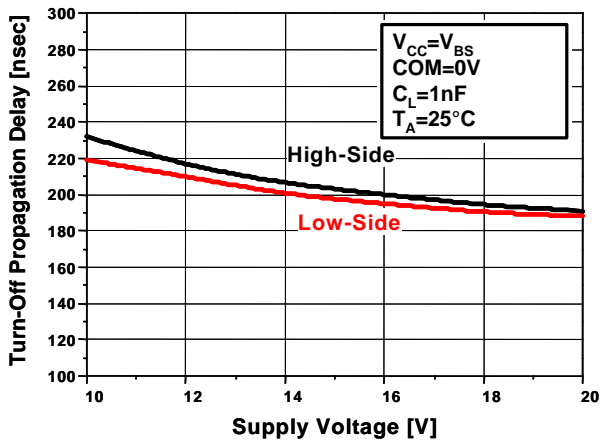

Figure 6. Turn-Off Propagation Delay vs. Supply Voltage

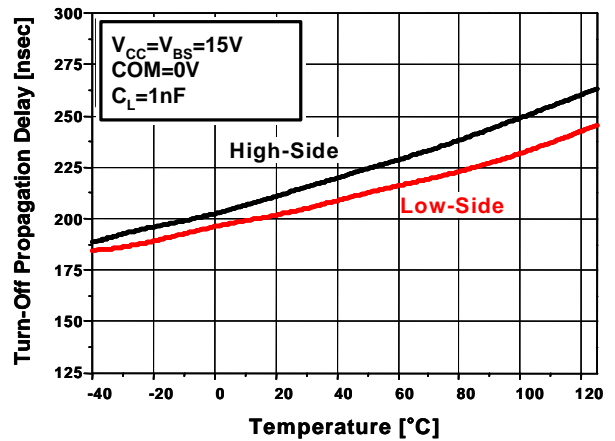

Figure 7. Turn-Off Propagation Delay vs. Temp.

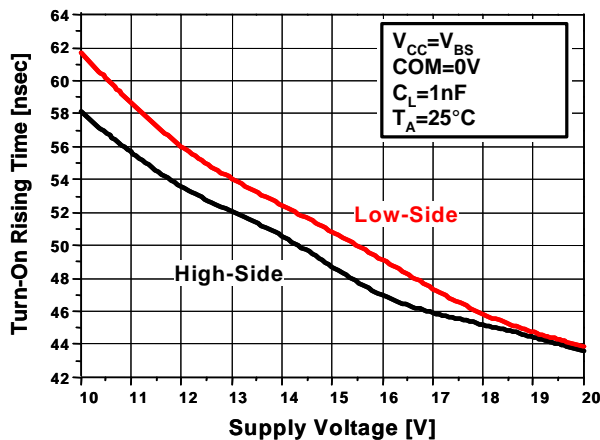

Figure 8. Turn-On Rising Time vs. Supply Voltage

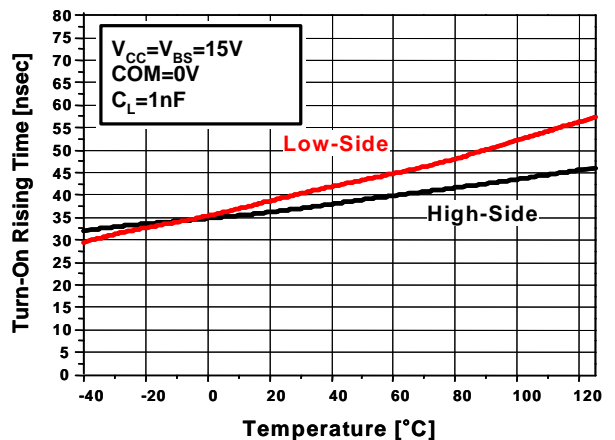

Figure 9. Turn-On Rising Time vs. Temp.

Typical Characteristics (Continued)

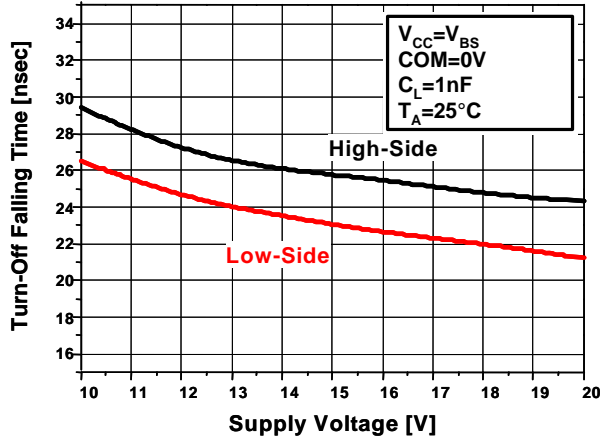

Figure 10. Turn-Off Falling Time vs. Supply Voltage

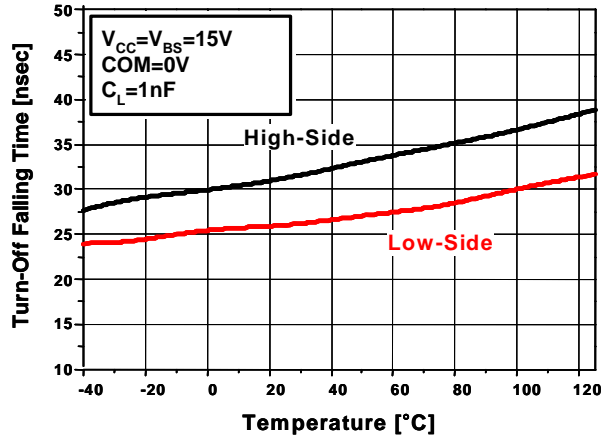

Figure 11. Turn-Off Falling Time vs. Temp.

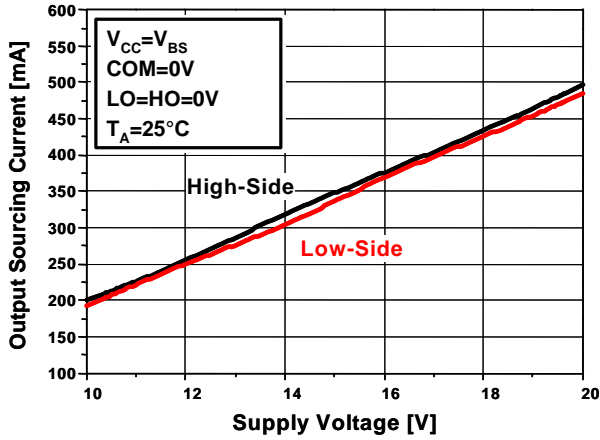

Figure 12. Output Sourcing Current vs. Supply Voltage

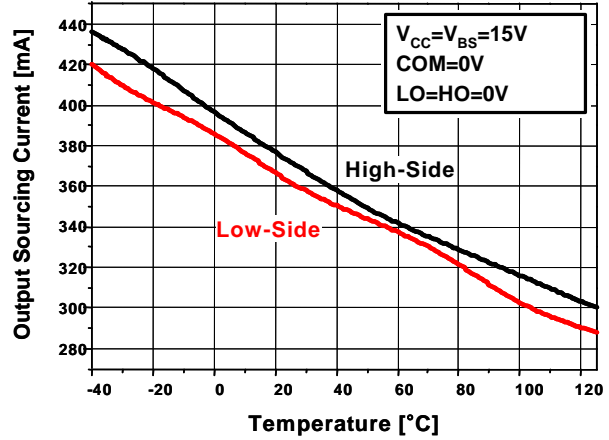

Figure 13. Output Sourcing Current vs. Temp

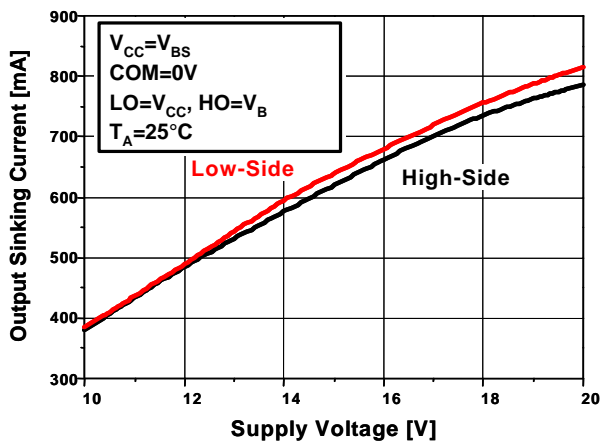

Figure 14. Output Sinking Current vs. Supply Voltage

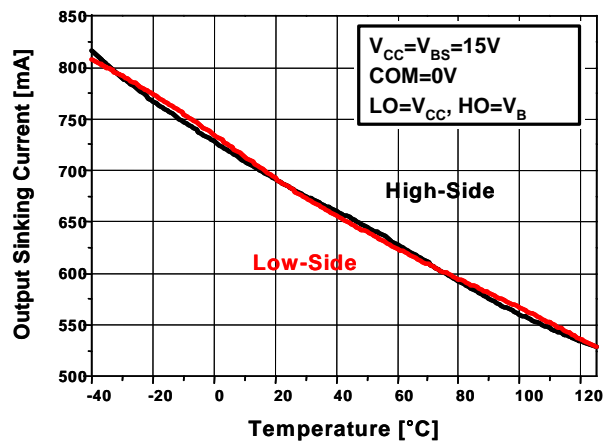

Figure 15. Output Sinking Current vs. Temp.

Typical Characteristics (Continued)

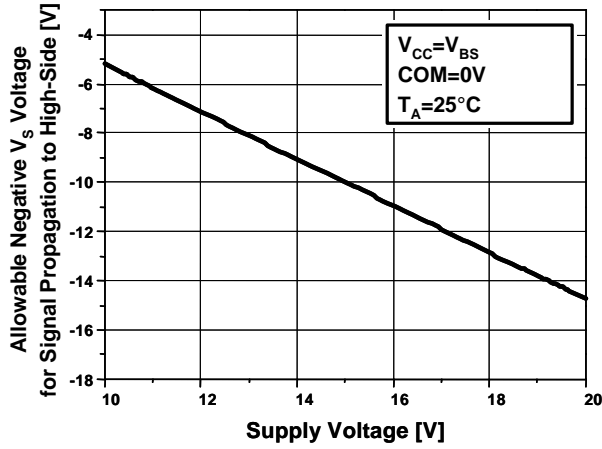

Figure 16. Allowable Negative V_S Voltage for Signal Propagation to High Side vs. Supply Voltage

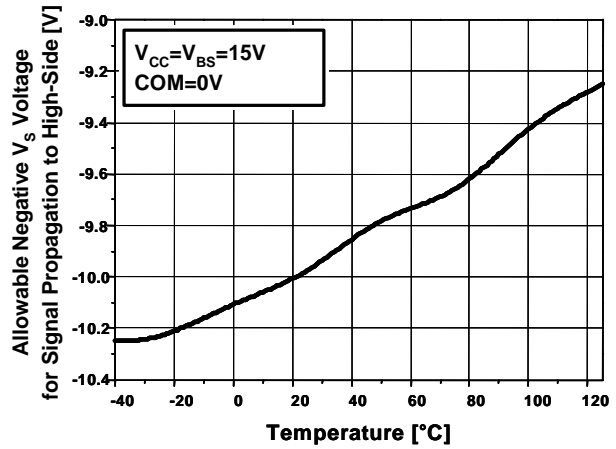

Figure 17. Allowable Negative V_S Voltage for Signal Propagation to High Side vs. Temp.

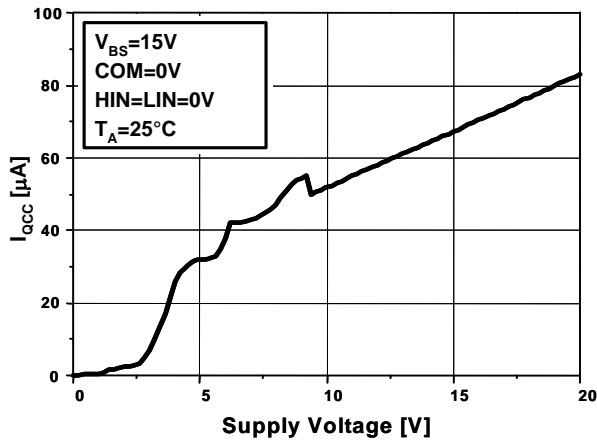

Figure 18. I_{QCC} vs. Supply Voltage

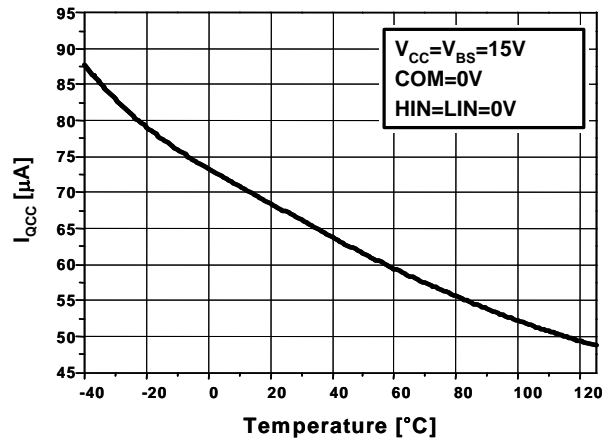

Figure 19. I_{QCC} vs. Temp.

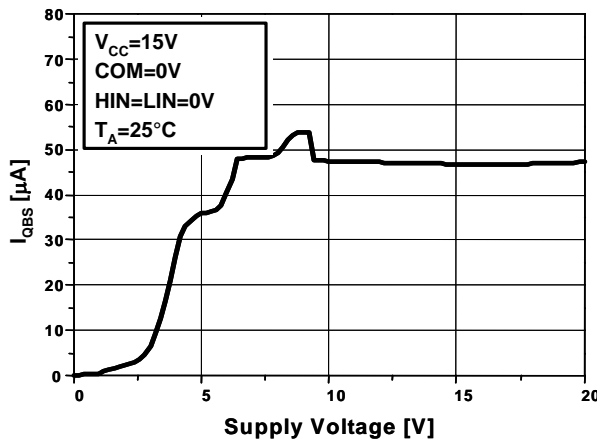

Figure 20. I_{QBS} vs. Supply Voltage

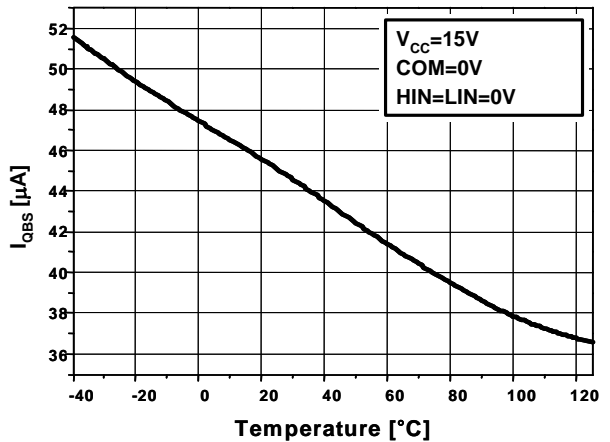

Figure 21. I_{QBS} vs. Temp.

Typical Characteristics (Continued)

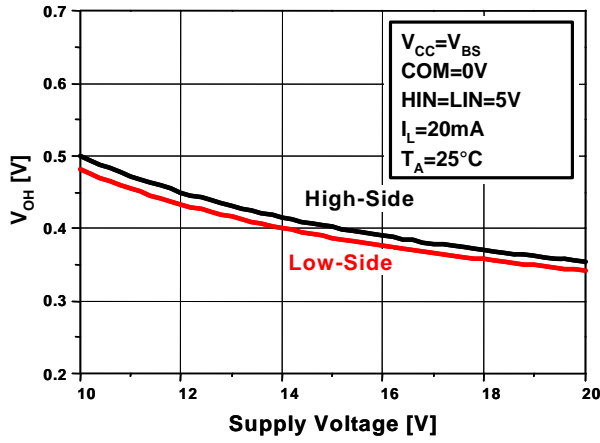

Figure 22. High-Level Output Voltage vs. Supply Voltage

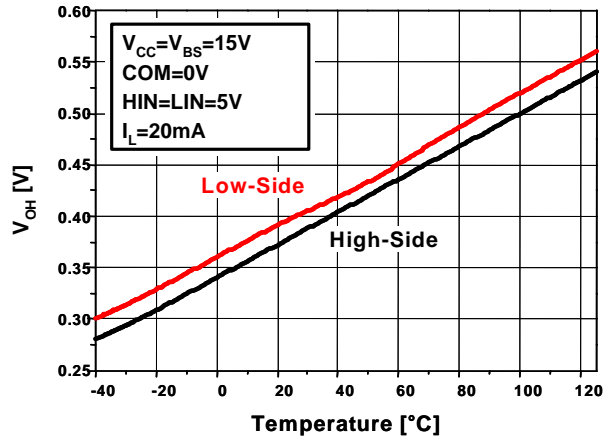

Figure 23. High-Level Output Voltage vs. Temp.

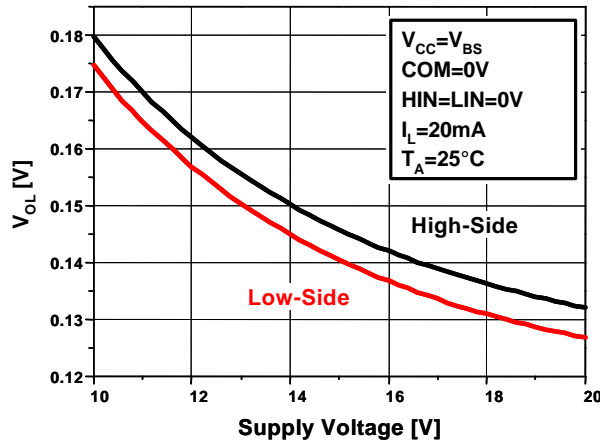

Figure 24. Low-Level Output Voltage vs. Supply Voltage

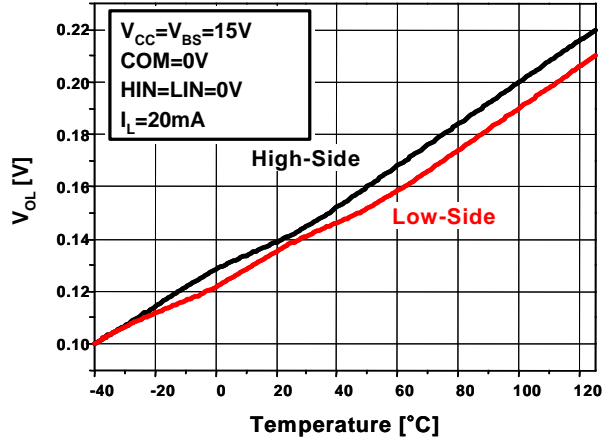

Figure 25. Low-Level Output Voltage vs. Temp.

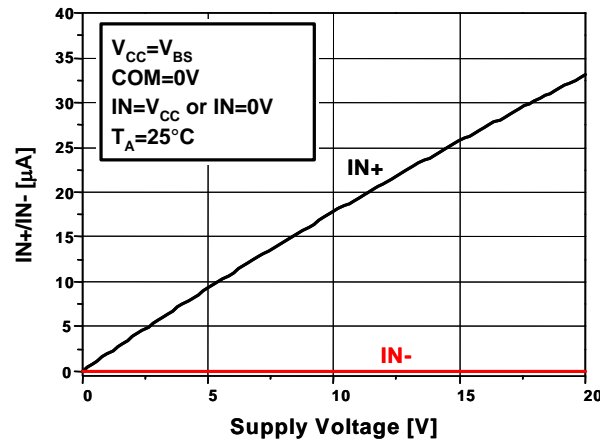

Figure 26. Input Bias Current vs. Supply Voltage

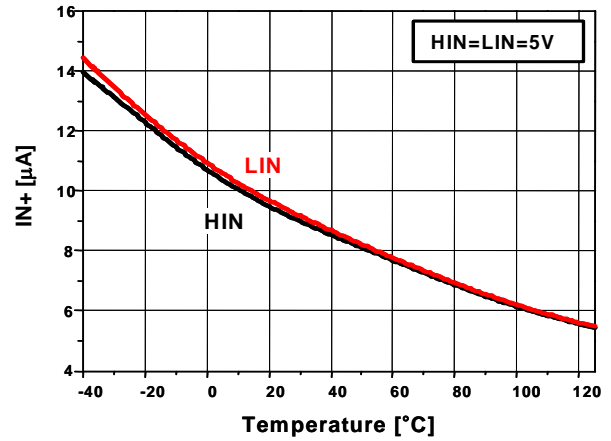

Figure 27. Input Bias Current vs. Temp.

Typical Characteristics (Continued)

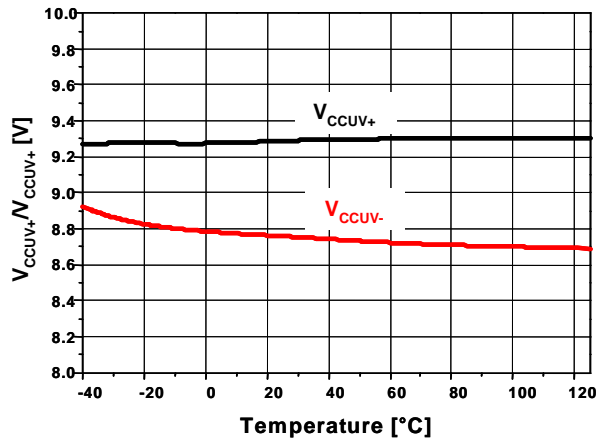

Figure 28. V_{CC} UVLO Threshold Voltage vs. Temp.

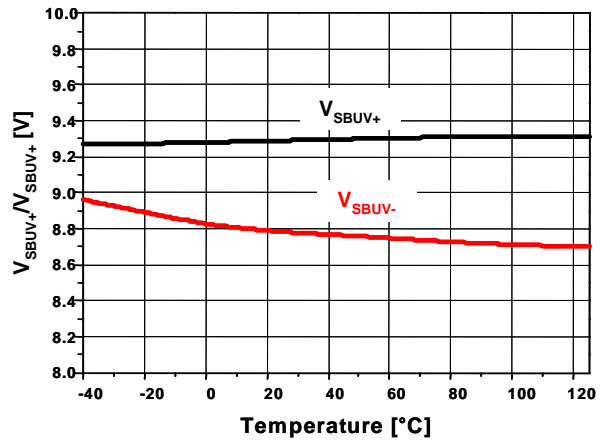

Figure 29. V_{BS} UVLO Threshold Voltage vs. Temp.

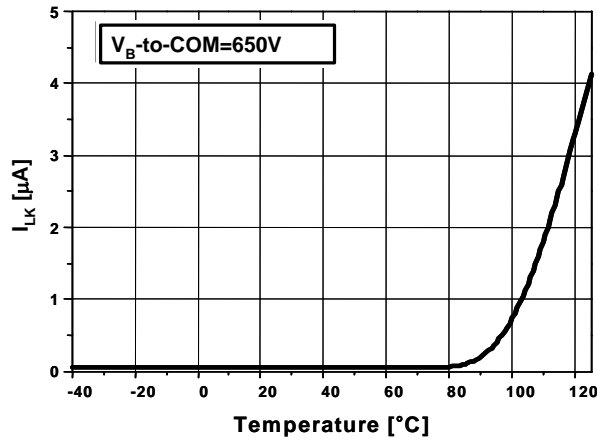

Figure 30. V_B to COM Leakage Current vs. Temp.

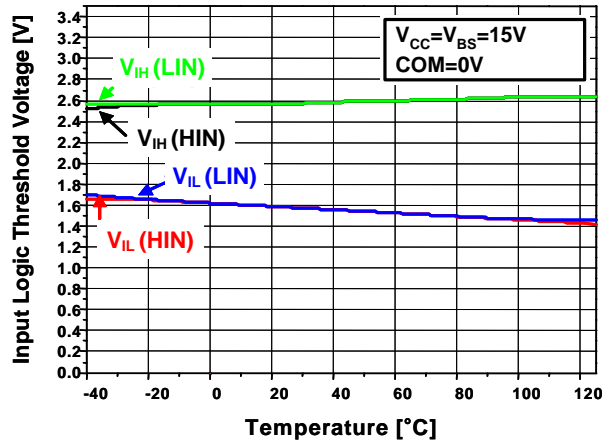

Figure 31. Input Logic Threshold Voltage vs. Temp.

Typical Characteristics (Continued)

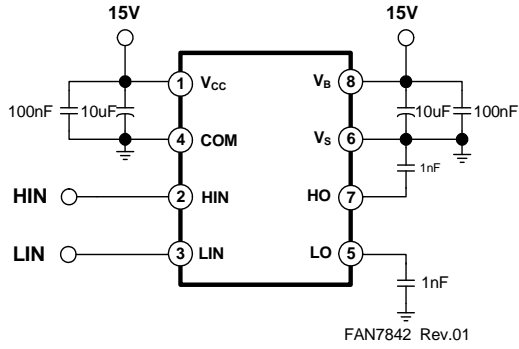

Figure 32. Switching Time Test Circuit

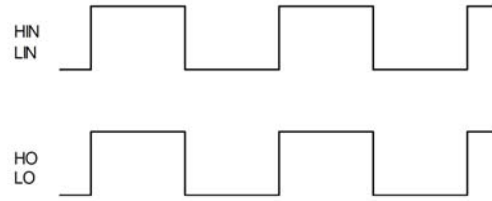

Figure 33. Input / Output Timing Diagram

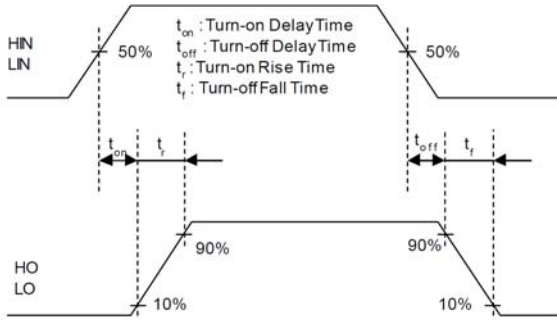

Figure 34. Switching Time Waveform Definition

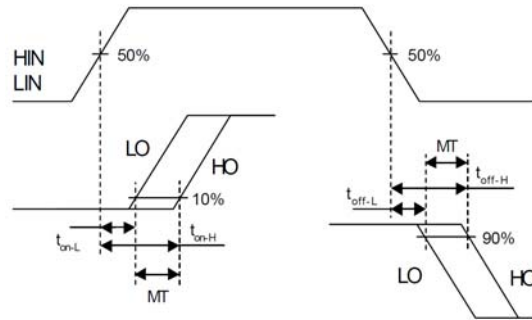

Figure 35. Delay Matching Waveform Definition



TOP VIEW



LAND PATTERN RECOMMENDATION



FRONT VIEW



OPTION A
BEVEL EDGE

OPTION B
NON-BEVEL EDGE

SIDE VIEW



DETAIL "B"
SCALE 2:1

NOTES: UNLESS OTHERWISE SPECIFIED

- A. THIS PACKAGE CONFORMS TO JEDEC MS-012 VARIATION A EXCEPT WHERE NOTED.
- B. ALL DIMENSIONS ARE IN MILLIMETERS
- $\triangle C$ OUT OF JEDEC STANDARD VALUE
- D. DIMENSIONS ARE EXCLUSIVE OF BURRS, MOLD FLASH AND TIE BAR EXTRUSIONS.
- E. LAND PATTERN AS PER IPC SOIC127P600X175-8M
- F. DRAWING FILENAME: MKT-M08Brev2



ON Semiconductor and  are trademarks of Semiconductor Components Industries, LLC dba ON Semiconductor or its subsidiaries in the United States and/or other countries. ON Semiconductor owns the rights to a number of patents, trademarks, copyrights, trade secrets, and other intellectual property. A listing of ON Semiconductor's product/patent coverage may be accessed at www.onsemi.com/site/pdf/Patent-Marking.pdf. ON Semiconductor reserves the right to make changes without further notice to any products herein. ON Semiconductor makes no warranty, representation or guarantee regarding the suitability of its products for any particular purpose, nor does ON Semiconductor assume any liability arising out of the application or use of any product or circuit, and specifically disclaims any and all liability, including without limitation special, consequential or incidental damages. Buyer is responsible for its products and applications using ON Semiconductor products, including compliance with all laws, regulations and safety requirements or standards, regardless of any support or applications information provided by ON Semiconductor. "Typical" parameters which may be provided in ON Semiconductor data sheets and/or specifications can and do vary in different applications and actual performance may vary over time. All operating parameters, including "Typicals" must be validated for each customer application by customer's technical experts. ON Semiconductor does not convey any license under its patent rights nor the rights of others. ON Semiconductor products are not designed, intended, or authorized for use as a critical component in life support systems or any FDA Class 3 medical devices or medical devices with a same or similar classification in a foreign jurisdiction or any devices intended for implantation in the human body. Should Buyer purchase or use ON Semiconductor products for any such unintended or unauthorized application, Buyer shall indemnify and hold ON Semiconductor and its officers, employees, subsidiaries, affiliates, and distributors harmless against all claims, costs, damages, and expenses, and reasonable attorney fees arising out of, directly or indirectly, any claim of personal injury or death associated with such unintended or unauthorized use, even if such claim alleges that ON Semiconductor was negligent regarding the design or manufacture of the part. ON Semiconductor is an Equal Opportunity/Affirmative Action Employer. This literature is subject to all applicable copyright laws and is not for resale in any manner.

PUBLICATION ORDERING INFORMATION

LITERATURE FULFILLMENT:

Literature Distribution Center for ON Semiconductor
19521 E. 32nd Pkwy, Aurora, Colorado 80011 USA
Phone: 303-675-2175 or 800-344-3860 Toll Free USA/Canada
Fax: 303-675-2176 or 800-344-3867 Toll Free USA/Canada
Email: orderlit@onsemi.com

N. American Technical Support: 800-282-9855 Toll Free
USA/Canada
Europe, Middle East and Africa Technical Support:
Phone: 421 33 790 2910
Japan Customer Focus Center
Phone: 81-3-5817-1050

ON Semiconductor Website: www.onsemi.com
Order Literature: <http://www.onsemi.com/orderlit>
For additional information, please contact your local
Sales Representative

Mouser Electronics

Authorized Distributor

Click to View Pricing, Inventory, Delivery & Lifecycle Information:

[ON Semiconductor:](#)

[FAN7842MX](#) [FAN7842M](#)