

Data Sheet

LL01CR-CFExxL02

XICATO



XTM-9MM LES



■ Features & Typical Applications

- High efficiency
- Available with 3 beam angles
- Optimized Uniformity
- Lens without Connector
- Architectural Lighting
- Commercial Lighting
- Spotlight

■ Table of Contents

General Information & Product Nomenclature.....	P.2
Optical Specifications	P.3
Mechanical Specifications.....	P.4
Package Specifications	P.5

LL01CR-CFExxL02

General Information

- Lens Material : SABIC 2180T.
- Operating Temperature range -40°C~+110°C(upper limit +120°C).
- Storage Temperature range -40°C~+110°C(upper limit +120°C).
 - * Average transmittance in visible spectrum 400nm~700nm>90%.
- Usage and Maintenance:
 1. If necessary, clean lenses with mild soap, water and soft cloth.
 2. Never use any commercial cleaning solvents on lenses, like alcohol.
 3. Please handle or install lenses with wearing gloves, skin oils may damage lens or its optical characteristic.

Product Nomenclature

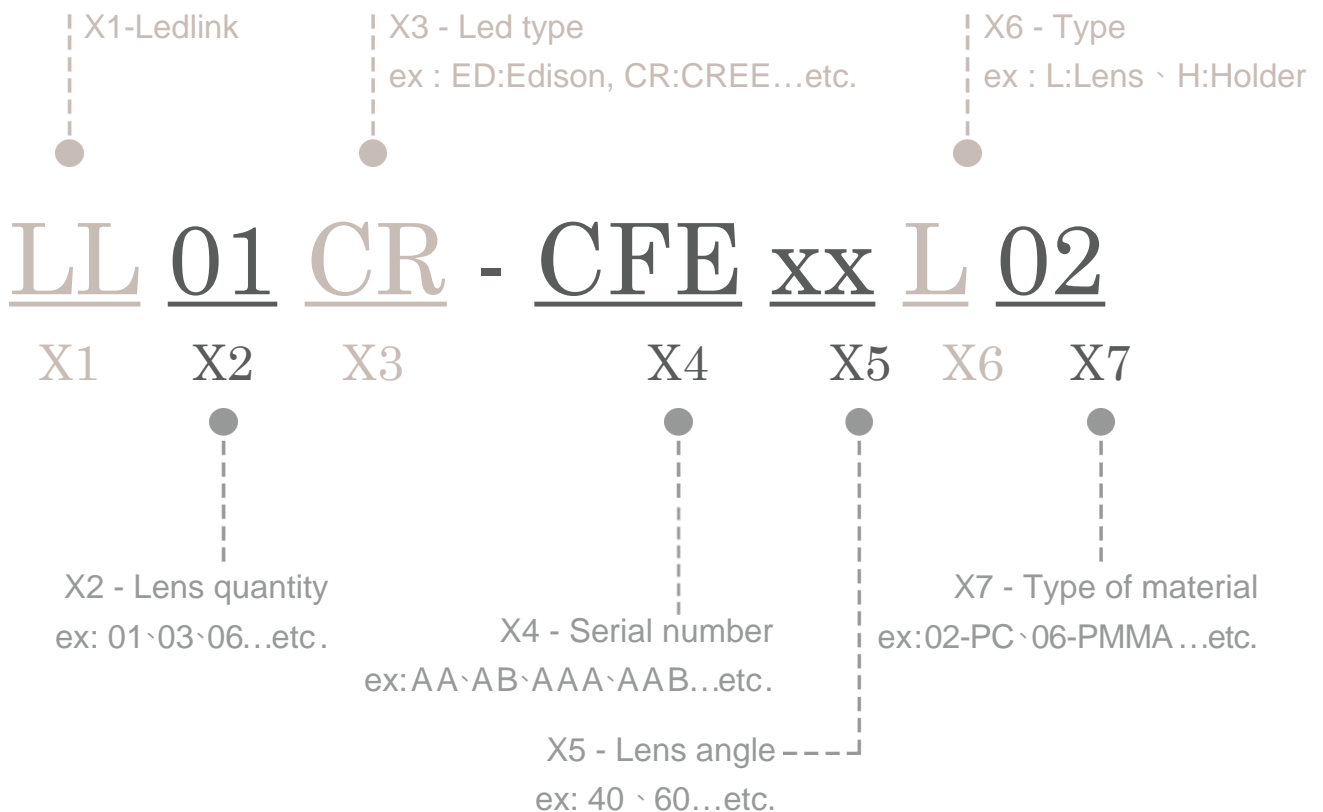

LL01CR-CFExxL02 Optical Specifications

XICATO



XTM-9MM LES

Note: (1) All the results of analysis are based on 0 degrees of elevation.
 (2) Tolerance: $\pm 10\%$.
 (3) Led Luminous Flux(lm): 325($\pm 5\%$).

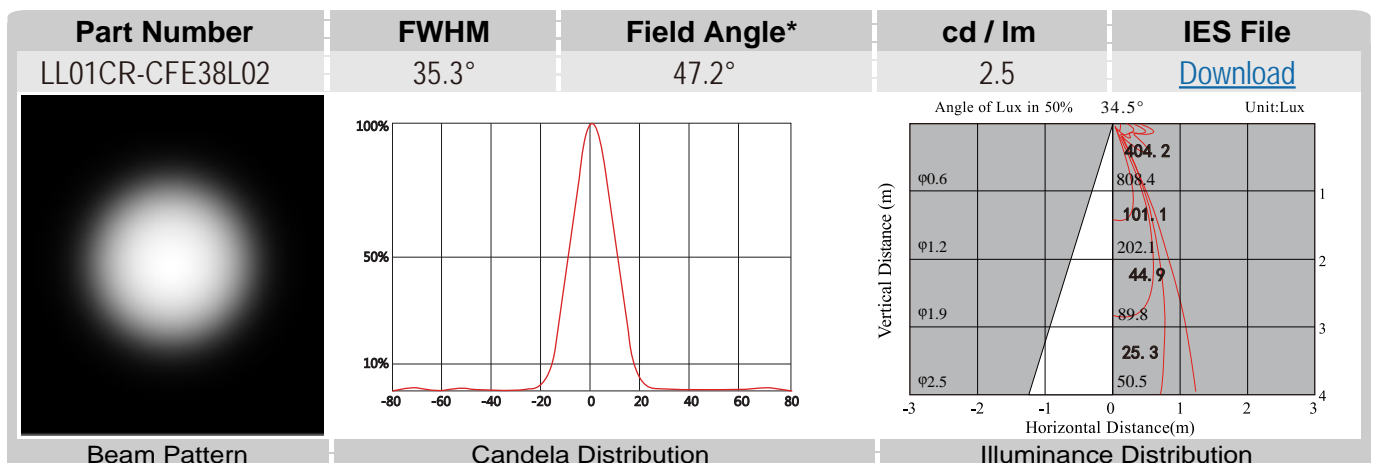
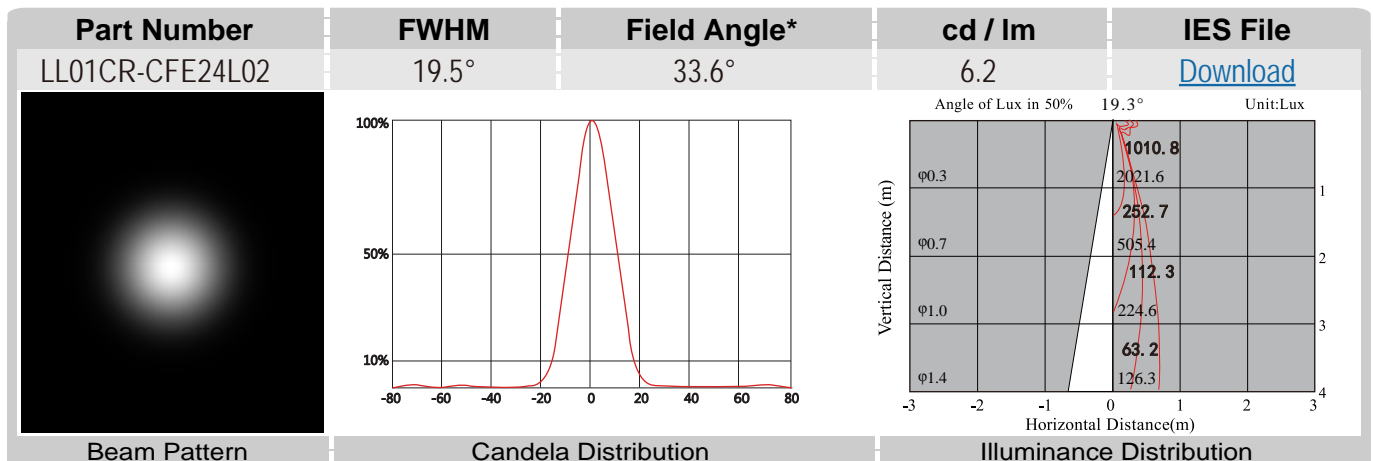
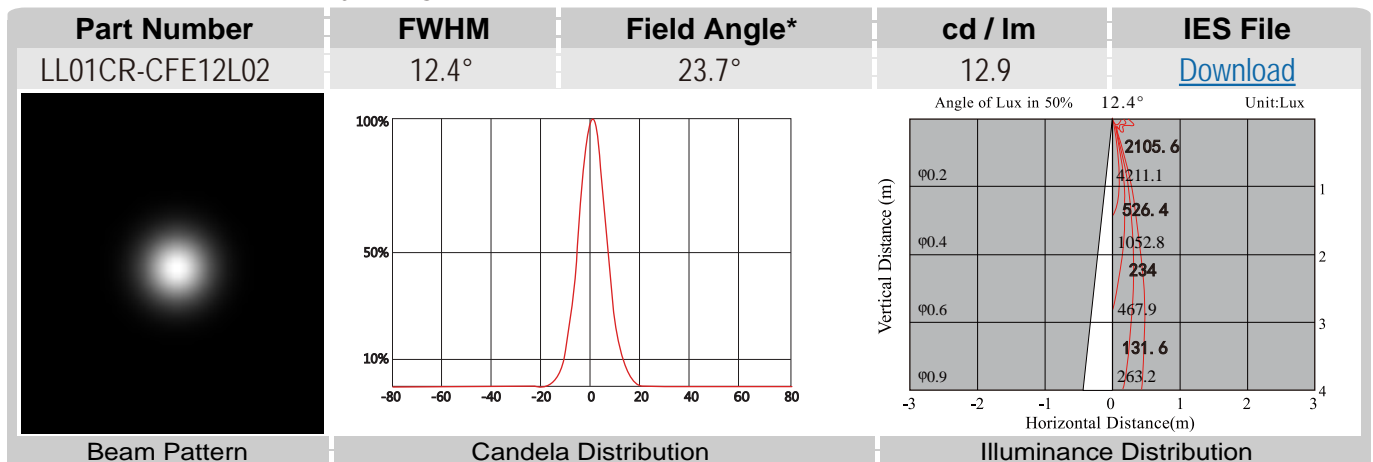

*The Field Angle is the angle between the two directions opposed to each other over the beam axis for which the luminous intensity is 10% that of the maximum luminous intensity.
 *This testing result is obtained through testing the popular rank LED samples which provided by the original manufacturer. Hence, the testing results would be varied as the users choose same LED model but different rank.

LL01CR-CFExxL02 Mechanical Specification

1. Fixing method

 Glue

 Screw

 Tape

 Fixing-ring

 Frame

Note: (1) All dimensions are in mm.
 (2) All tolerance are ± 0.15 mm unless otherwise specified.

2. Lens dimension

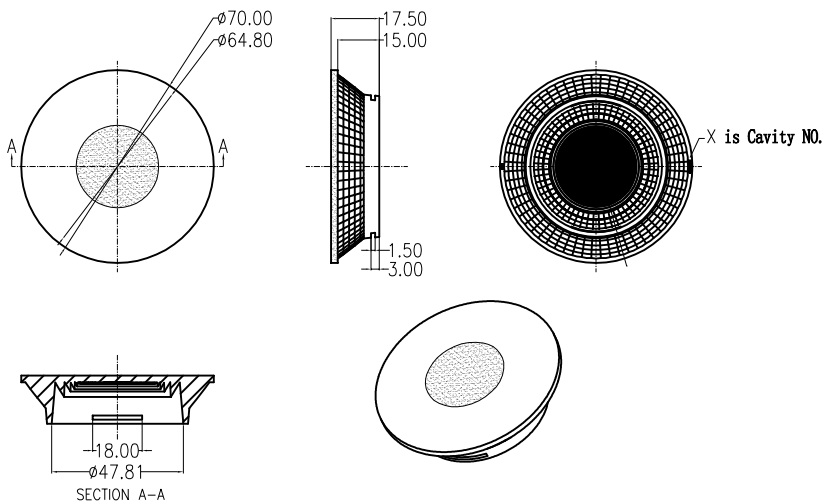

3. Assembly instruction

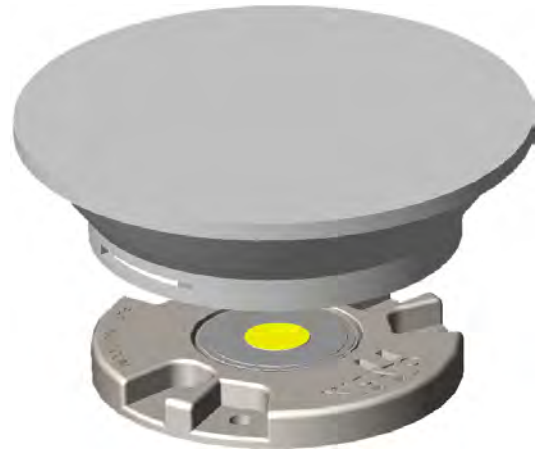

4. Connector dimension

5. View assembly lens with LED:



LL01CR-CFExxL02 Package Specifications

Item	Quantity	Total	Size(L*W*H)	G.W
plastic box	20 pcs/plastic box	20 pcs	38*26*2.1 cm	28.3g
outer box	90 plastic box/outer box	180 pcs	35*31*21 cm	

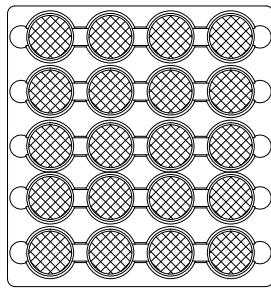

LL-0657

20 pcs/plastic box

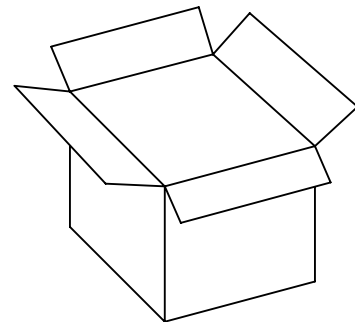
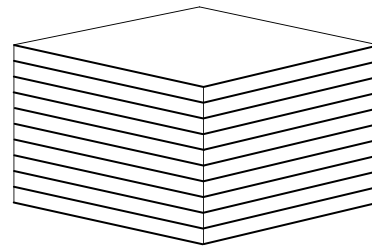

180 pcs/outer box



Note: