

**STR. MALE MODULE 4 SOLDER TYPE INSERTS**

**R694.251.026**

**3 MM FOR PCB**

Series : MCC2

4 Coax Position AB/1A,1C

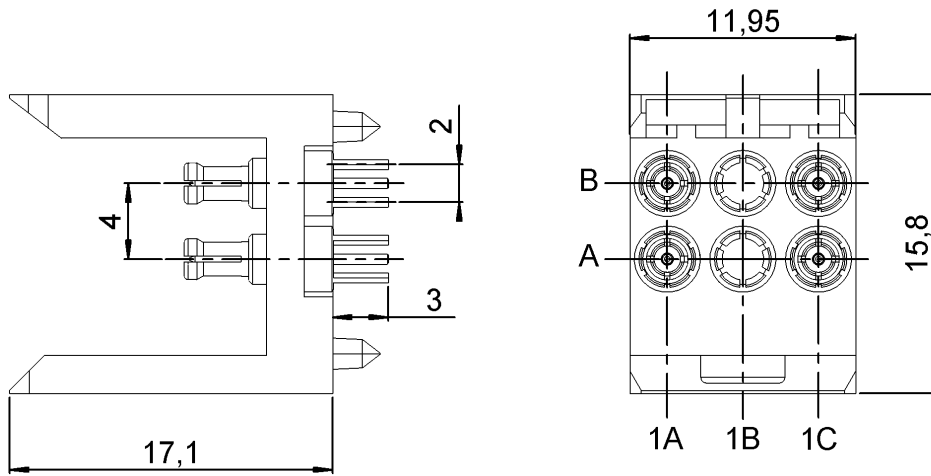

Connectors' packaging

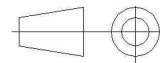
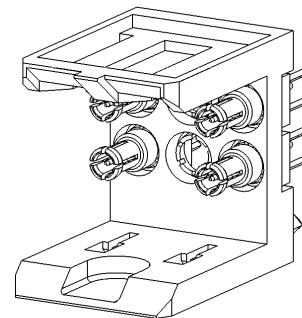
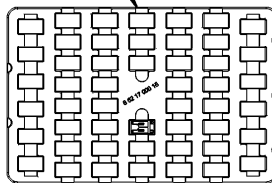
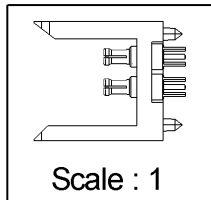

All dimensions are in mm.

COMPONENTS	MATERIALS	PLATING (µm)
BODY	BRONZE	NPGR
CENTER CONTACT	BRASS	NPGR
OUTER CONTACT	BRONZE	NPGR
INSULATOR	PTFE	
GASKET	-	
OTHERS PARTS	LIQUID CRISTAL POLYMER	
-	-	-
-	-	-

Issue : 0624 C

In the effort to improve our products, we reserve the right to make changes judged to be necessary.



**STR. MALE MODULE 4 SOLDER TYPE INSERTS**

**R694.251.026**

**3 MM FOR PCB**

Series : MCC2

**PACKAGING**

**SPECIFICATION**

Standard	Unit	Other
<b>50</b>	<b>'W' option</b>	<b>Contact us</b>

**ELECTRICAL CHARACTERISTICS**

**ENVIRONMENTAL**

Impedance	<b>50</b>	$\Omega$
Frequency	<b>0-6</b>	GHz
VSWR	<b>1.12 + 0,0000</b>	x F(GHz) Maxi
Insertion loss	<b>0.2</b>	$\sqrt{F}$ (GHz) dB Maxi
RF leakage	- (	- F(GHz)) dB Maxi
Voltage rating	<b>500</b>	Veff Maxi
Dielectric withstanding voltage	<b>750</b>	Veff mini
Insulation resistance	<b>5000</b>	M $\Omega$ mini

Operating temperature	<b>-25/+125</b>	$^{\circ}$ C
Hermetic seal	<b>NA</b>	Atm.cm3/s
Panel leakage	<b>NA</b>	

**OTHER CHARACTERISTICS**

Assembly instruction

Others :  
VSWR=1.12 optimized between DC to 3GHz

**MECHANICAL CHARACTERISTICS**

Center contact retention		
Axial force – Mating end	<b>6</b>	N mini
Axial force – Opposite end	<b>6</b>	N mini
Torque	<b>NA</b>	N.cm mini
Recommended torque		
Mating	<b>NA</b>	N.cm
Panel nut	<b>NA</b>	N.cm
Mating life	<b>500</b>	Cycles mini
Weight	<b>97,8400</b>	g

Issue : 0624 C

In the effort to improve our products, we reserve the right to make changes judged to be necessary.



STR. MALE MODULE 4 SOLDER TYPE INSERTS

R694.251.026

3 MM FOR PCB

Series : MCC2

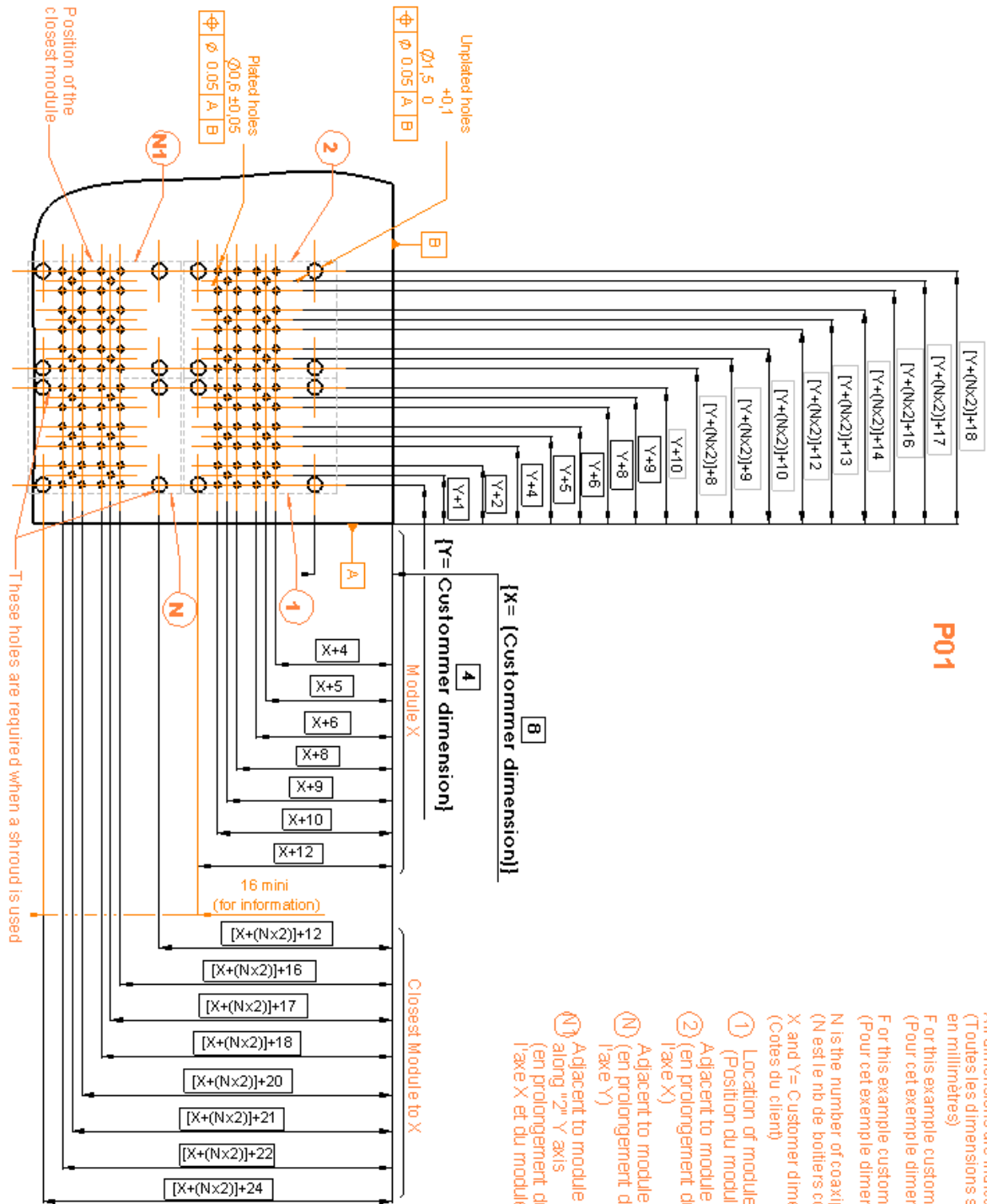

- All dimensions are indicated in millimetres (Toutes les dimensions sont indiquées en millimètres)
- F or this example customer dimension X=8mm (Pour cet exemple dimension du client X=8mm)
- F or this example customer dimension Y=4mm (Pour cet exemple dimension du client Y=4mm)
- N is the number of coaxialpack 2 (N est le nb de boîtiers coaxialpack 2)
- X and Y = Customer dimensions (Codes du client)
- ① Location of module "1"
  - ② Position of module "1" along X axis (en prolongement du module "1" selon l'axe X)
  - ③ Adjacent to module "1" along Y axis (en prolongement du module "1" selon l'axe Y)
  - ④ Adjacent to module "N" along X axis and along "2<sup>nd</sup>" Y axis (en prolongement du module "N" selon l'axe X et du module 2 selon l'axe Y)

Issue : 0624 C

In the effort to improve our products, we reserve the right to make changes judged to be necessary.



**STR. MALE MODULE 4 SOLDER TYPE INSERTS**

**R694.251.026**

**3 MM FOR PCB**

Series : MCC2

- Place the coax connector(s) on the PCB

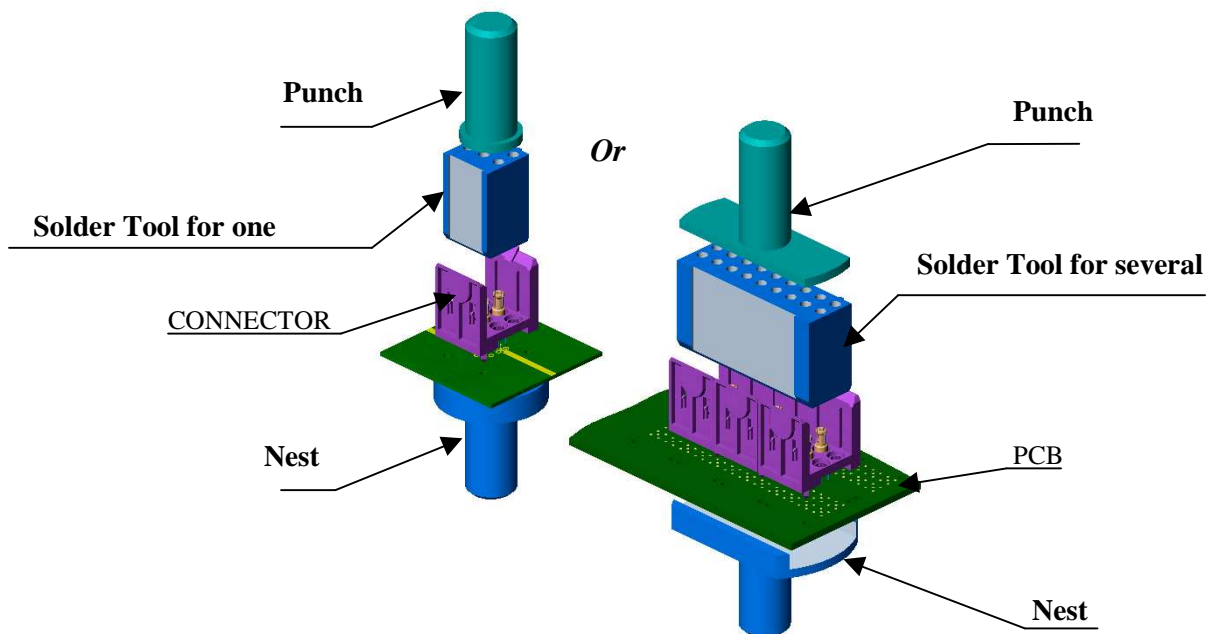

- Place correctly the PCB between the punch and the nest of the press.
- In case of multiple housing configuration , use a punch and a nest large enough to cover all the housings.
- Ensure solder legs are properly aligned with the holes before press-mounting.
- Press on the housing(s) with the punch until the complete insertion of the fixing stud into the PCB.

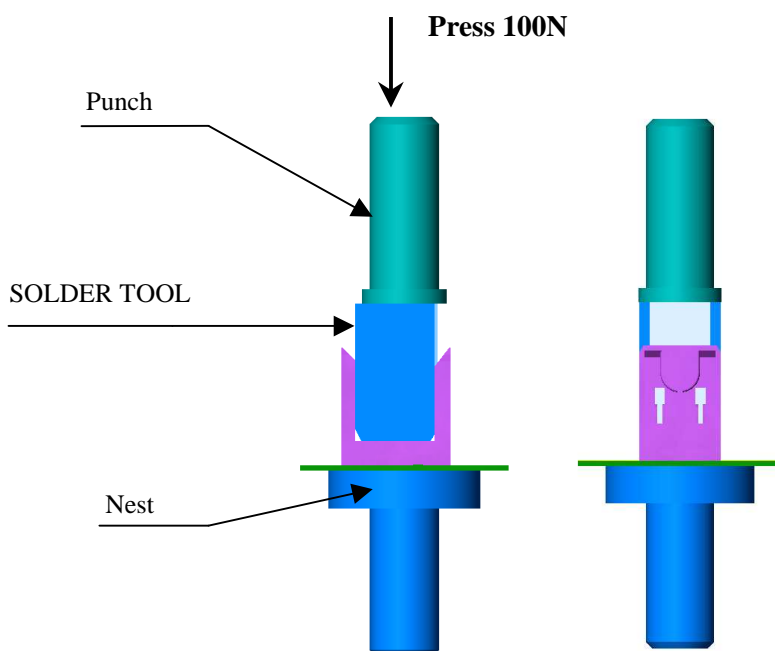

Issue : 0624 C

In the effort to improve our products, we reserve the right to make changes judged to be necessary.



**STR. MALE MODULE 4 SOLDER TYPE INSERTS****R694.251.026****3 MM FOR PCB**

Series : MCC2

- After the insertion of the connectors on the printed circuit , leave the solder tool inserted in position.
- Solder the legs on board

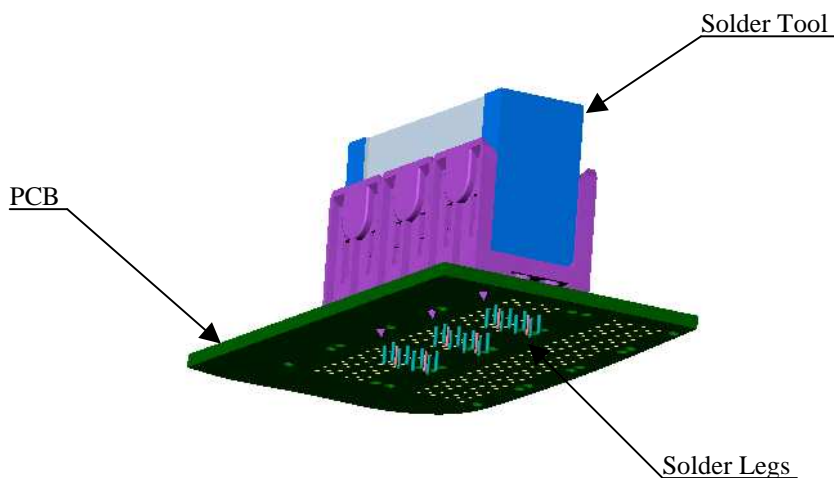

- After the solder legs have been soldered , using an appropriate soldering process , remove the solder tool.

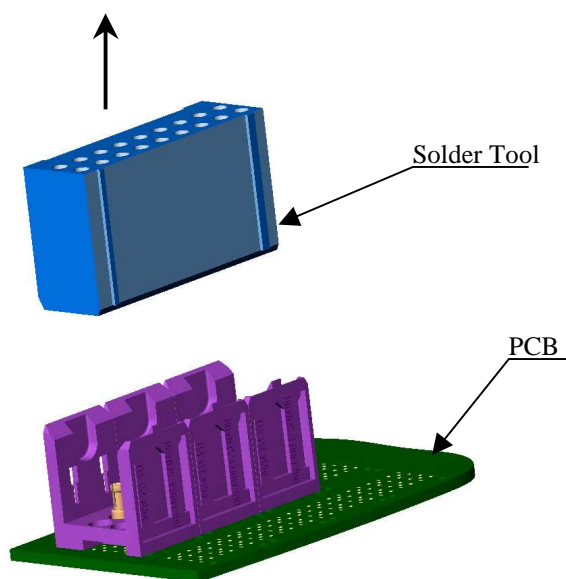

*Radiall do not recommend to use more than 3 modules on the same motherboard and can't be held liable of any connection defect when more than 3 modules are implemented on the board.*

Issue : 0624 C

In the effort to improve our products, we reserve the right to make changes judged to be necessary.

