

**Product Summary**

- $V_R = 60V$
- $I_F = 500mA$
- $I_R = 40\mu A$

**Description and Applications**

- DC – DC Converters
- Mobile Telecomms
- PCMIA

**Features and Benefits**

- High current capability ( $I_F = 500mA$ )
- Low  $V_F$
- **Qualified to AEC-Q101 Standards for High Reliability**

**Mechanical Data**

- Case: SOT23
- Case Material: Molded Plastic, "Green" Molding Compound. UL Flammability Classification Rating 94V-0
- Moisture Sensitivity: Level 1 per J-STD-020
- Terminals: Matte Tin Finish annealed over Alloy 42 leadframe (Lead Free Plating). Solderable per MIL-STD-202, Method 208
- Weight: 0.0089 grams (approximate)

SOT23



Top View

**Ordering Information** (Note 1)

Device	Packaging	Shipping
ZHCS506TA	SOT23	3000/Tape & Reel

 Notes: 1. For Packaging Details, go to our website at <http://www.diodes.com>.

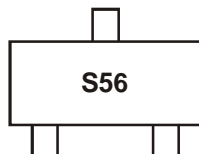
**Marking Information**

S56 = Product Type Marking Code

**Maximum Ratings** @ $T_A = 25^\circ\text{C}$  unless otherwise specified

Characteristic	Symbol	Value	Units
Continuous Reverse Voltage	$V_R$	60	V
Continuous Forward Current	$I_F$	500	mA
Forward Voltage @ $I_F = 500\text{mA}$	$V_F$	630	mV
Average Peak Forward Current; D.C. = 50%	$I_{FAV}$	1000	mA
Non Repetitive Forward Current	$I_{FSM}$	$t \leq 100\mu\text{s}$	A
		$t \leq 10\text{ms}$	A

**Thermal Characteristics**

Characteristic	Symbol	Value	Unit
Power Dissipation, $T_A = 25^\circ\text{C}$	$P_D$	330	mW
Junction Temperature	$T_J$	125	$^\circ\text{C}$
Storage Temperature Range	$T_{STG}$	-55 to +150	$^\circ\text{C}$

**Electrical Characteristics** @ $T_A = 25^\circ\text{C}$  unless otherwise specified

Characteristic	Symbol	Min	Typ	Max	Unit	Test Condition
Reverse Breakdown Voltage	$V_{(BR)R}$	60	80	-	V	$I_R = 200\mu\text{A}$
Forward Voltage (Note 2)	$V_F$	-	275	310	mV	$I_F = 50\text{mA}$
		-	320	360		$I_F = 100\text{mA}$
		-	415	470		$I_F = 250\text{mA}$
		-	550	630		$I_F = 500\text{mA}$
		-	680	800		$I_F = 750\text{mA}$
		-	820	960		$I_F = 1\text{A}$
		-	1120	1350		$I_F = 1.5\text{A}$
		-	565	-		$I_F = 500\text{mA}, T_A = 100^\circ\text{C}$
Reverse Current	$I_R$	-	20	40	$\mu\text{A}$	$V_R = 45\text{V}$
Diode Capacitance	$C_D$	-	20	-	pF	$f = 1\text{MHz}, V_R = 25\text{V}$
Reverse Recovery Time	$t_{rr}$	-	10	-	ns	Switched from $I_F = 500\text{mA}$ to $I_R = 500\text{mA}$ Measured @ $I_R = 50\text{mA}$

Notes: 2. Measured under pulsed conditions. Pulse width =  $300\mu\text{s}$ . Duty cycle = 2%.

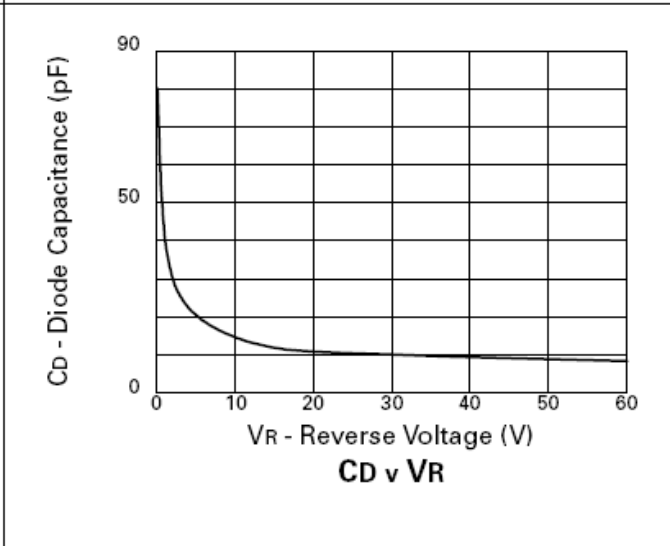
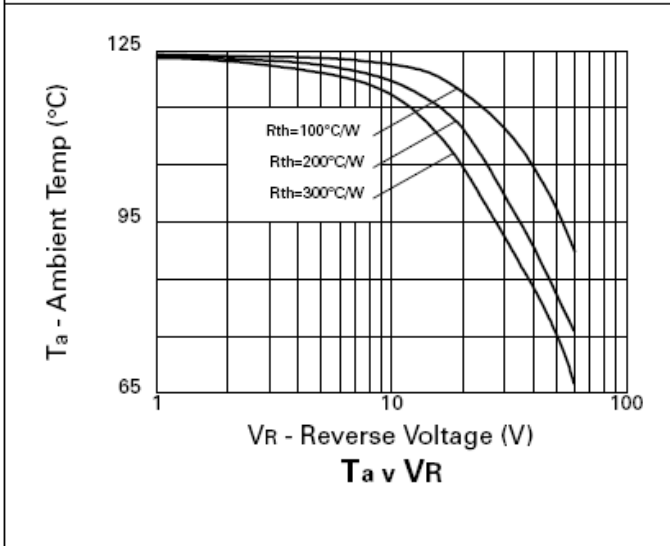
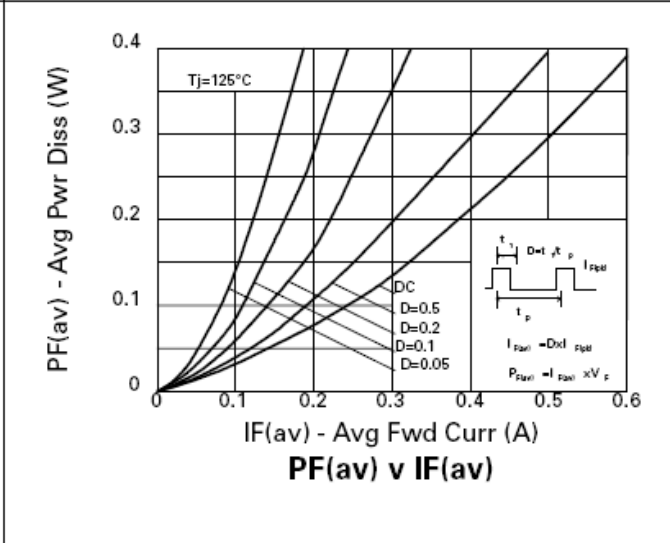
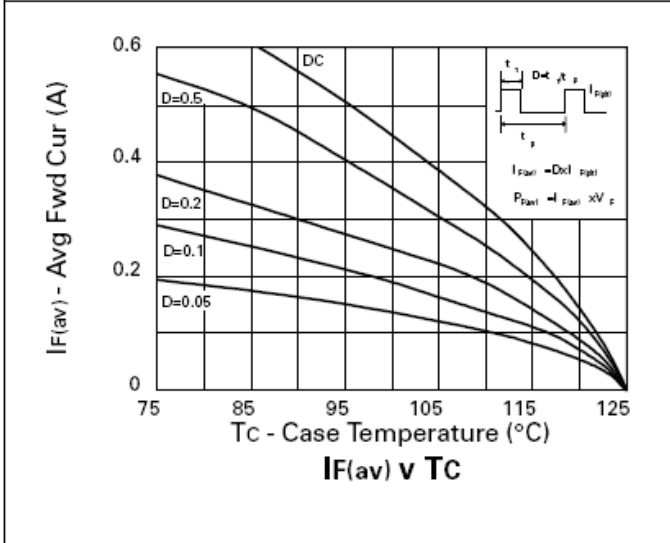
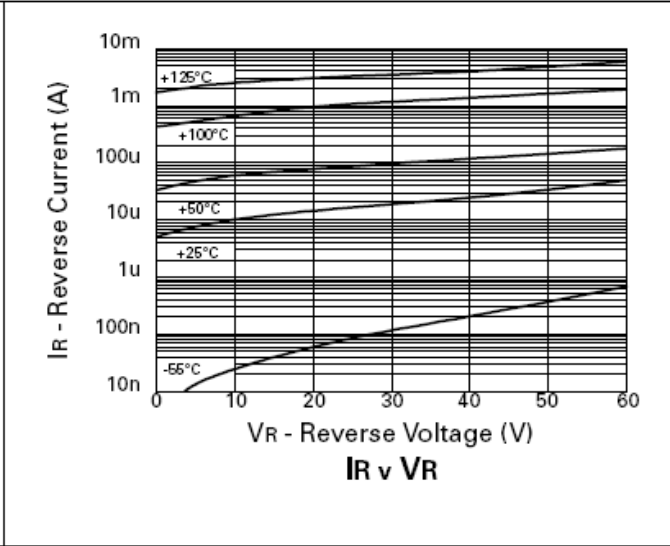
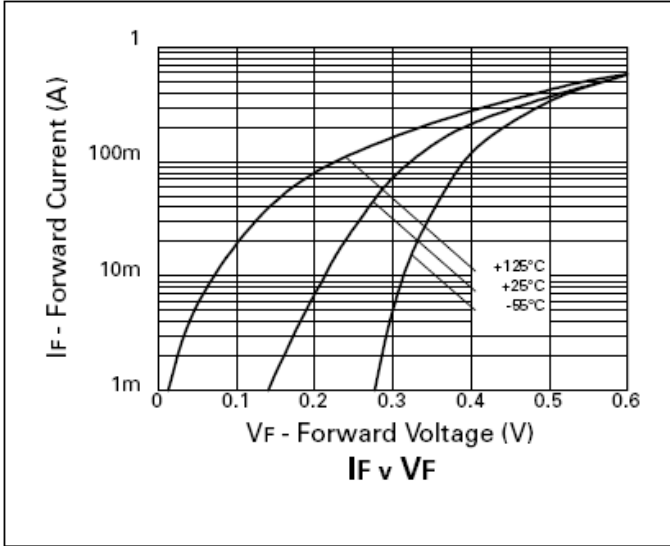

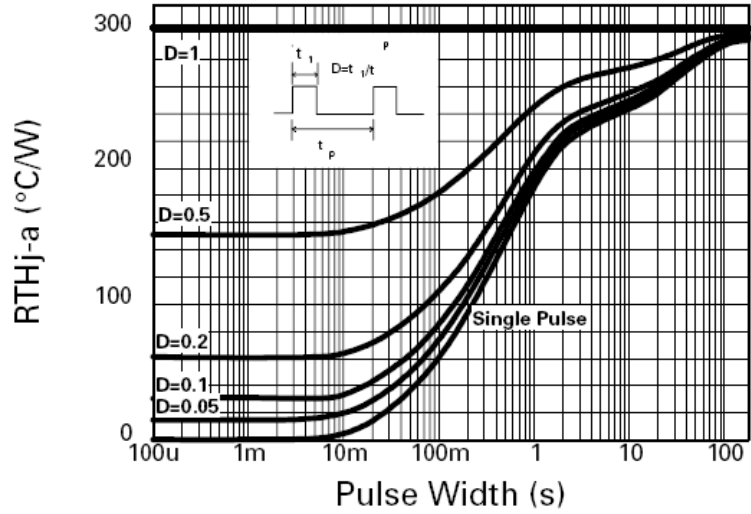

**Package Outline Dimensions**

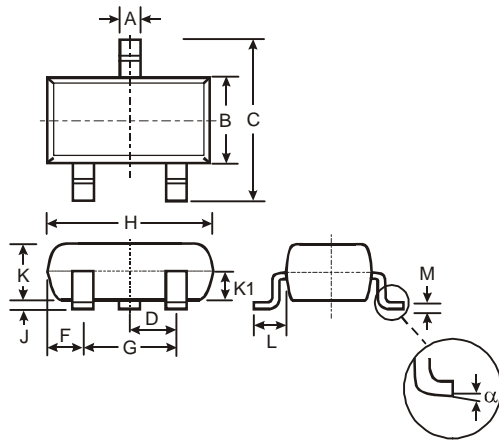

SOT23			
Dim	Min	Max	Typ
A	0.37	0.51	0.40
B	1.20	1.40	1.30
C	2.30	2.50	2.40
D	0.89	1.03	0.915
F	0.45	0.60	0.535
G	1.78	2.05	1.83
H	2.80	3.00	2.90
J	0.013	0.10	0.05
K	0.903	1.10	1.00
K1	-	-	0.400
L	0.45	0.61	0.55
M	0.085	0.18	0.11
$\alpha$	0°	8°	-
All Dimensions in mm			

**Suggested Pad Layout**

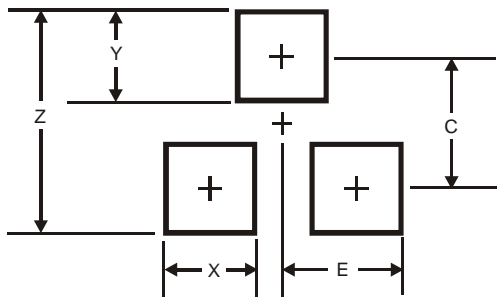

Dimensions	Value (in mm)
Z	2.9
X	0.8
Y	0.9
C	2.0
E	1.35

**IMPORTANT NOTICE**

DIODES INCORPORATED MAKES NO WARRANTY OF ANY KIND, EXPRESS OR IMPLIED, WITH REGARDS TO THIS DOCUMENT, INCLUDING, BUT NOT LIMITED TO, THE IMPLIED WARRANTIES OF MERCHANTABILITY AND FITNESS FOR A PARTICULAR PURPOSE (AND THEIR EQUIVALENTS UNDER THE LAWS OF ANY JURISDICTION).

Diodes Incorporated and its subsidiaries reserve the right to make modifications, enhancements, improvements, corrections or other changes without further notice to this document and any product described herein. Diodes Incorporated does not assume any liability arising out of the application or use of this document or any product described herein; neither does Diodes Incorporated convey any license under its patent or trademark rights, nor the rights of others. Any Customer or user of this document or products described herein in such applications shall assume all risks of such use and will agree to hold Diodes Incorporated and all the companies whose products are represented on Diodes Incorporated website, harmless against all damages.

Diodes Incorporated does not warrant or accept any liability whatsoever in respect of any products purchased through unauthorized sales channel. Should Customers purchase or use Diodes Incorporated products for any unintended or unauthorized application, Customers shall indemnify and hold Diodes Incorporated and its representatives harmless against all claims, damages, expenses, and attorney fees arising out of, directly or indirectly, any claim of personal injury or death associated with such unintended or unauthorized application.

Products described herein may be covered by one or more United States, international or foreign patents pending. Product names and markings noted herein may also be covered by one or more United States, international or foreign trademarks.

**LIFE SUPPORT**

Diodes Incorporated products are specifically not authorized for use as critical components in life support devices or systems without the express written approval of the Chief Executive Officer of Diodes Incorporated. As used herein:

A. Life support devices or systems are devices or systems which:

1. are intended to implant into the body, or
2. support or sustain life and whose failure to perform when properly used in accordance with instructions for use provided in the labeling can be reasonably expected to result in significant injury to the user.

B. A critical component is any component in a life support device or system whose failure to perform can be reasonably expected to cause the failure of the life support device or to affect its safety or effectiveness.

Customers represent that they have all necessary expertise in the safety and regulatory ramifications of their life support devices or systems, and acknowledge and agree that they are solely responsible for all legal, regulatory and safety-related requirements concerning their products and any use of Diodes Incorporated products in such safety-critical, life support devices or systems, notwithstanding any devices- or systems-related information or support that may be provided by Diodes Incorporated. Further, Customers must fully indemnify Diodes Incorporated and its representatives against any damages arising out of the use of Diodes Incorporated products in such safety-critical, life support devices or systems.

Copyright © 2011, Diodes Incorporated

[www.diodes.com](http://www.diodes.com)