

Data Sheet

Description

The ASMF-LWG4-NxxxD Surface Mount LEDs use InGaN chip technology with superior package design to enable them to produce higher light output with better flux performance. The product can be driven at high current and is able to dissipate the heat more efficiently, which results in better performance with reliability.

These LEDs operate under a wide range of environmental conditions, making them ideal for various applications including fluorescent replacement, under-cabinet lighting, retail display lighting, and panel lights.

To facilitate easy pick-and-place assembly, the LEDs are packed in tape and reel format. Every reel is shipped in single flux and color bin to provide close uniformity.

Features

- High reliability package with enhanced silicone resin encapsulation.
- Available in 2700K, 3000K, 3500K, 4000K, 5000K, 5700K, 6200K, 6500K, and 6800K CCT only.
- Low thermal resistance at 15°C/W.
- Wide angle viewing angle at 120°.
- Low package profile and large emitting area for better uniformity in linear lighting.
- JEDEC MSL 3.

Applications

- For lightings and luminaries.
- Electronic signs and signals
 - Channel lettering
 - Contour lighting
 - Indoor variable message sign
- Office automations, home appliances, industrial equipment
 - Front panel backlighting
 - Push button backlighting
 - Display backlighting
 - Scanner lighting

CAUTION: ASMF-LWG4-NxxxD LEDs are ESD sensitive. Please observe appropriate precautions during handling and processing. Refer to Broadcom Application Note AN-1142 for additional details.

Figure 1 Package Drawing

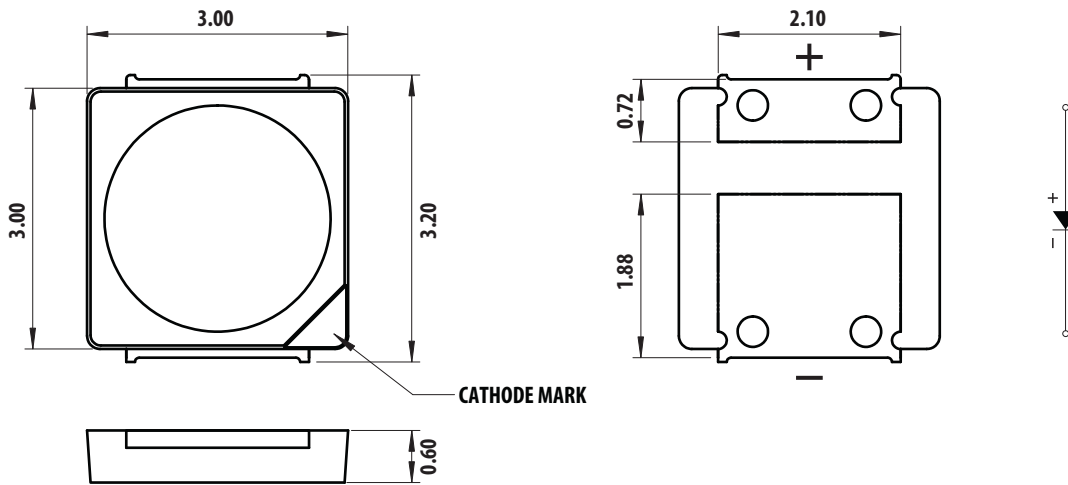

NOTE

1. All dimensions are in millimeters.
2. Dimensions in brackets are for reference only.
3. Tolerance ± 0.2 mm unless otherwise specified.
4. Terminal finish = silver plating

Performance

Device Selection Guide at 65 mA ($T_j = 25^\circ\text{C}$)

Part Number	Correlated Color Temperature, CCT (K)	Luminous Flux, Φ_V (lm) ^{a, b}			Luminous Efficiency (lm/W)	Dice Technology
		Min.	Typ.	Max.		
ASMF-LWG4-NQTAD	2700	22.0	24.3	30.0	128.9	InGaN
ASMF-LWG4-NQTB	3000	22.0	25.0	30.0	132.6	InGaN
ASMF-LWG4-NRUCD	3500	24.0	26.0	32.0	137.9	InGaN
ASMF-LWG4-NRUDD	4000	24.0	27.0	32.0	143.2	InGaN
ASMF-LWG4-NRUED	5000	24.0	27.0	32.0	143.2	InGaN
ASMF-LWG4-NRUFD	5700	24.0	27.0	32.0	143.2	InGaN
ASMF-LWG4-NRUGD	6200	24.0	27.0	32.0	143.2	InGaN
ASMF-LWG4-NRUHD	6500	24.0	27.0	32.0	143.2	InGaN
ASMF-LWG4-NRUJD	6800	24.0	26.5	32.0	140.6	InGaN

a. The luminous flux, Φ_V is the total luminous flux output as measured with an integrating sphere at mono pulse condition.
 b. Flux tolerance is $\pm 12\%$.

Absolute Maximum Ratings

Parameter	ASMF-LWG4-NxxxD	Unit
DC Forward Current ^a	240	mA
Peak Forward Current ^b	270	mA
Power Dissipation	744	mW
LED Junction Temperature	125	°C
Operating Temperature Range	-40 to 100	°C
Storage Temperature Range	-40 to 100	°C

- a. Derate linearly as shown in Figure 15 and Figure 16.
 b. Duty factor = 10%, frequency = 1 kHz.

Optical and Electrical Characteristics at 65 mA ($T_J = 25^\circ\text{C}$)

Parameter	Min.	Typ.	Max.	Unit
Viewing Angle, $2\theta_{1/2}$ ^a	—	120	—	°
Forward Voltage, V_F ^b	2.60	2.90	3.10	V
Reverse Voltage, V_R at $I_R = 100 \mu\text{A}$	Not designed for reverse bias			
Color Rendering Index, CRI	80	—	—	—
Thermal Resistance, $R\theta_{J-S}$ ^c	—	15	—	°C/W

- a. $\theta_{1/2}$ is the off-axis angle where the luminous intensity is 1/2 the peak intensity.
 b. Forward voltage, V_F tolerance: ± 0.1 V.
 c. Thermal resistance from LED junction to solder point.

Performance Characteristics ($T_J = 25^\circ\text{C}$)

Forward Current (mA)	Relative Luminous Flux (normalized at 65 mA)	Luminous Flux, Φ_V (lm)	Forward Voltage, V_F (V)	Luminous Efficiency (lm/W)
		Typ.	Typ.	Typ.
2700K				
10	0.161	4.0	2.73	146.5
20	0.320	7.8	2.77	140.8
30	0.476	11.6	2.80	138.1
40	0.630	15.4	2.83	136.0
50	0.780	19.0	2.86	132.9
60	0.927	22.6	2.89	130.3
65	1.000	24.3	2.90	128.9
80	1.213	29.5	2.94	125.4
100	1.489	36.2	2.99	121.1
120	1.754	42.7	3.03	117.4
150	2.137	52.0	3.08	112.6

Forward Current (mA)	Relative Luminous Flux (normalized at 65 mA)	Luminous Flux, Φ_V (lm)	Forward Voltage, V_F (V)	Luminous Efficiency (lm/W)
		Typ.	Typ.	Typ.
200	2.737	66.6	3.15	105.7
3000K				
10	0.161	4.1	2.73	150.2
20	0.320	8.0	2.77	144.4
30	0.476	11.9	2.80	141.7
40	0.630	15.8	2.83	139.6
50	0.780	19.5	2.86	136.4
60	0.927	23.2	2.89	133.8
65	1.000	25.0	2.90	132.6
80	1.213	30.4	2.94	129.3
100	1.489	37.3	2.99	124.7
120	1.754	43.9	3.03	120.7
150	2.137	53.5	3.08	115.8
200	2.737	68.5	3.15	108.7
3500K				
10	0.161	4.2	2.73	153.8
20	0.320	8.4	2.77	151.6
30	0.476	12.4	2.80	147.6
40	0.630	16.4	2.83	144.9
50	0.780	20.3	2.86	142.0
60	0.927	24.2	2.89	139.6
65	1.000	26.0	2.90	137.9
80	1.213	31.6	2.94	134.4
100	1.489	38.8	2.99	129.8
120	1.754	45.7	3.03	125.7
150	2.137	55.6	3.08	120.3
200	2.737	71.2	3.15	113.0
4000K, 5000K, 5700K, 6200K, and 6500K				
10	0.161	4.4	2.73	161.2
20	0.320	8.7	2.77	157.0
30	0.476	12.9	2.80	153.6
40	0.630	17.1	2.83	151.1
50	0.780	21.1	2.86	147.6
60	0.927	25.1	2.89	144.8
65	1.000	27.0	2.90	143.2
80	1.213	32.8	2.94	139.5
100	1.489	40.3	2.99	134.8
120	1.754	47.4	3.03	130.4
150	2.137	57.7	3.08	124.9

Forward Current (mA)	Relative Luminous Flux (normalized at 65 mA)	Luminous Flux, Φ_V (lm)	Forward Voltage, V_F (V)	Luminous Efficiency (lm/W)
		Typ.	Typ.	Typ.
200	2.737	73.9	3.15	117.3
6800K				
10	0.161	4.3	2.73	157.5
20	0.320	8.5	2.77	153.4
30	0.476	12.7	2.80	151.2
40	0.630	16.7	2.83	147.5
50	0.780	20.7	2.86	144.8
60	0.927	24.6	2.89	141.9
65	1.000	26.5	2.90	140.6
80	1.213	32.2	2.94	136.9
100	1.489	39.5	2.99	132.1
120	1.754	46.5	3.03	127.9
150	2.137	56.7	3.08	122.7
200	2.737	72.6	3.15	115.2

Part Numbering System

A S M F - L W x₁ 0 - N x₂ x₃ x₄ x₅

Code	Description	Option
x ₁	Color Rendering Index	G – CRI ≥ 80
x ₂	Minimum Flux Bin	(Refer to Flux Bin Limits)
x ₃	Maximum Flux Bin	
x ₄	Correlated Color Temperature	A – 2700K
		B – 3000K
		C – 3500K
		D – 4000K
		E – 5000K
		F – 5700K
		G – 6200K
		H – 6500K
x ₅	Test Option	J – 6800K
		D – Test Current = 65 mA

Part Number Example

ASMF-LWG4-NQTBD

x₁ – CRI ≥ 80

x₂ – Minimum flux bin M

x₃ – Maximum flux bin T

x₄ – Color bin 3000K with bin ID 29S

x₅ – Test current = 65 mA

Bin Information

Flux Bin Limits (CAT)

Bin ID	Luminous Flux, Φ_v (lm) at 65 mA	
	Min.	Max.
Q	22	24
R	24	26
S	26	28
T	28	30
U	30	32

Tolerance: $\pm 12\%$.

Forward Voltage Bin Limits (VF)

Bin ID	Forward Voltage, V_F (V) at 65 mA	
	Min.	Max.
G01	2.6	2.7
G02	2.7	2.8
G03	2.8	2.9
G04	2.9	3.0
G05	3.0	3.1

Tolerance: ± 0.1 V.

Example of bin information on reel and packaging label:

CAT: M – Flux bin M

BIN: 29S – Color bin 29S

VF: G05 – VF bin G05

Color Bin Limits (BIN)

CCT	Bin ID	Chromaticity Coordinates	
		x	y
2700	27S	0.4475	0.4012
		0.4582	0.4199
		0.4708	0.4228
		0.4598	0.4041
3000	29S	0.4295	0.3918
		0.4381	0.4097
		0.4515	0.4145
		0.4420	0.3962
3500	34S	0.4006	0.3811
		0.4061	0.3980
		0.4226	0.4056
		0.4150	0.3881
4000	41S	0.3699	0.3646
		0.3743	0.3846
		0.3885	0.3934
		0.3835	0.3741
5000	50S	0.3372	0.3449
		0.3378	0.3596
		0.3496	0.3694
		0.3478	0.3533
5700	58G	0.3220	0.3280
		0.3209	0.3425
		0.3330	0.3533
		0.3329	0.3375
6200	62G	0.3133	0.3214
		0.3113	0.3350
		0.3208	0.3444
		0.3219	0.3296
6500	64S	0.3079	0.3274
		0.3068	0.3354
		0.3181	0.3467
		0.3192	0.3387
6800	68G	0.3061	0.3145
		0.3035	0.3272
		0.3113	0.3350
		0.3133	0.3214

Tolerance: ± 0.01 .

Figure 2 Chromaticity Diagram

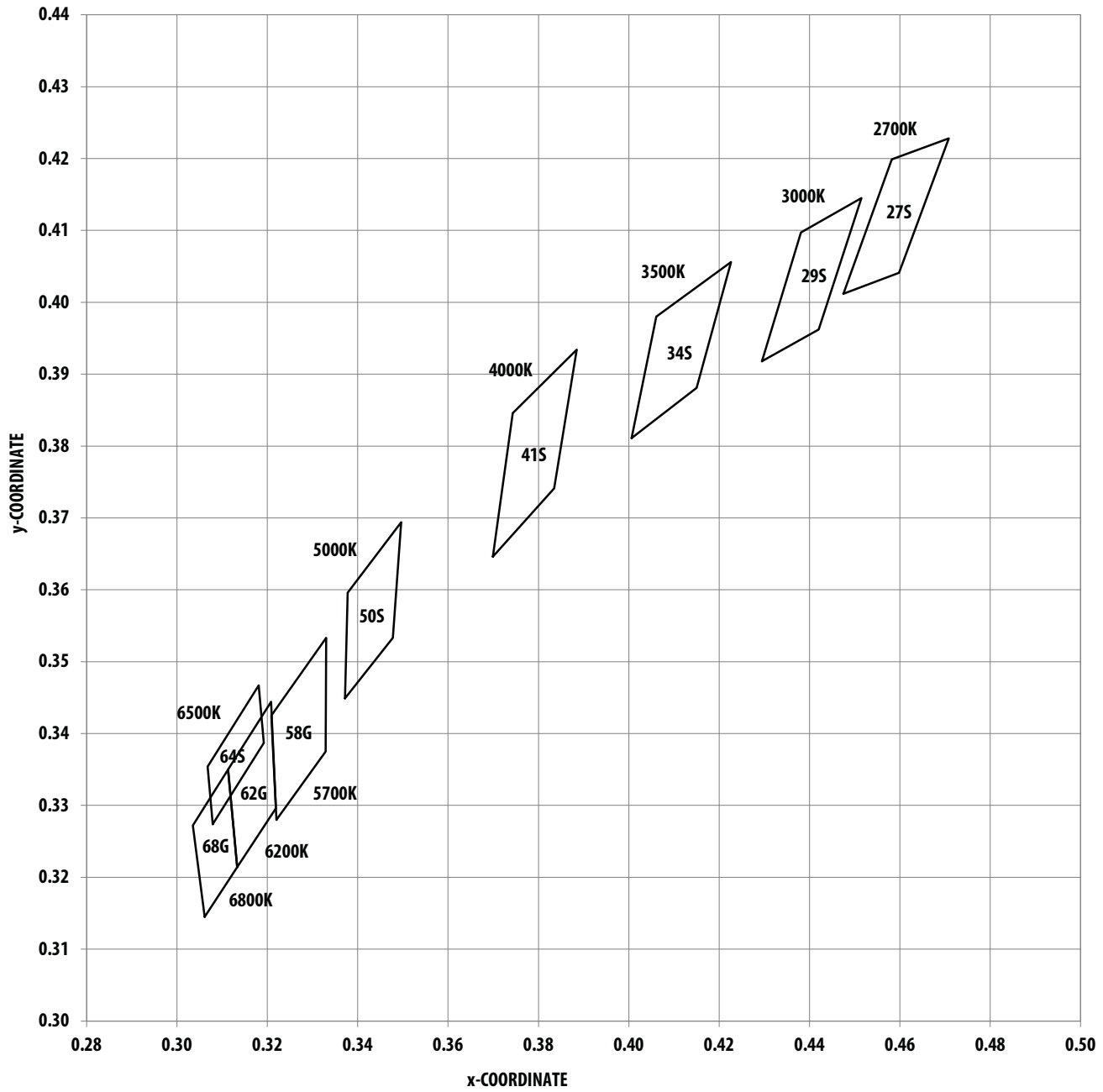

Figure 3 Relative Intensity vs. Wavelength

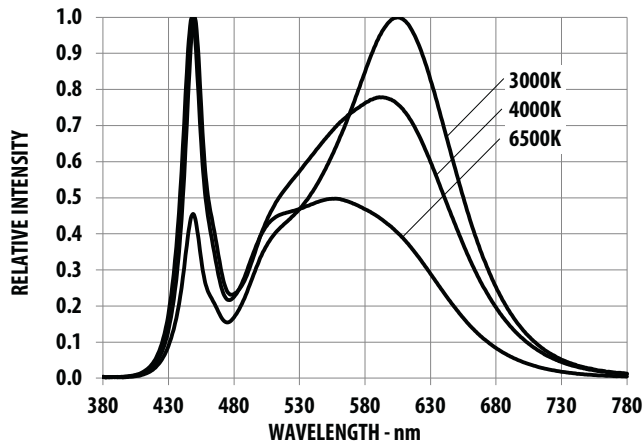

Figure 4 Forward Current vs. Forward Voltage

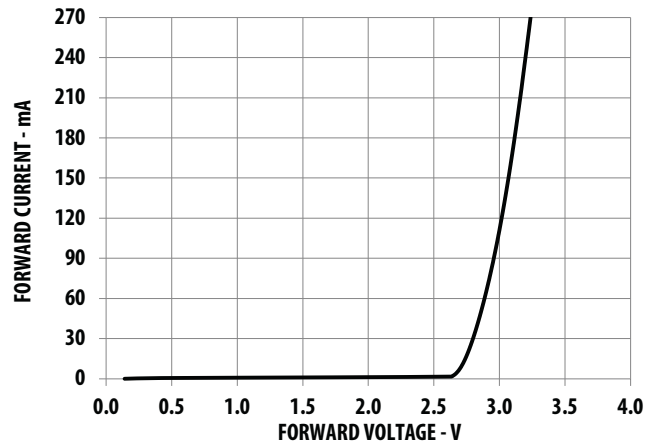

Figure 5 Relative Luminous Flux vs. Forward Current

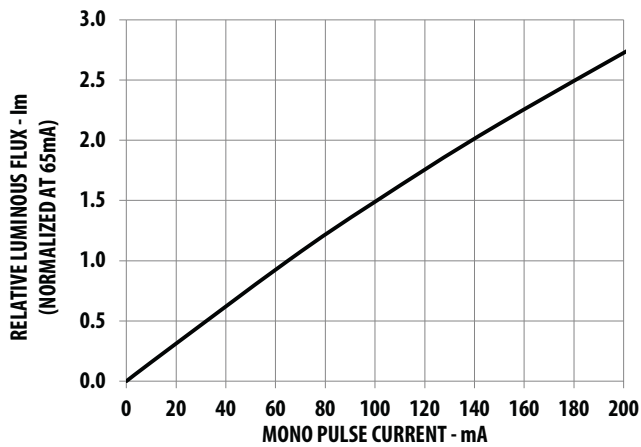

Figure 6 Radiation Pattern

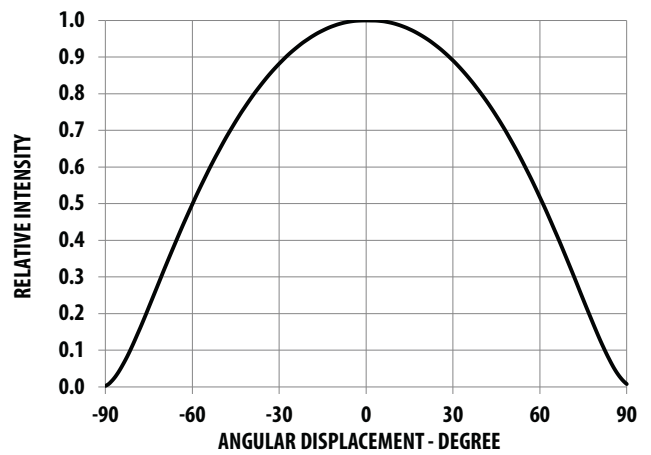

Figure 7 Chromaticity Coordinate Shift vs Forward Current for 3000K

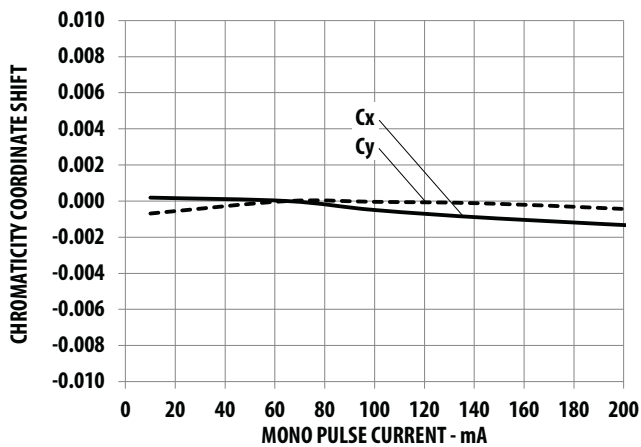

Figure 8 Chromaticity Coordinate Shift vs Forward Current for 4000K

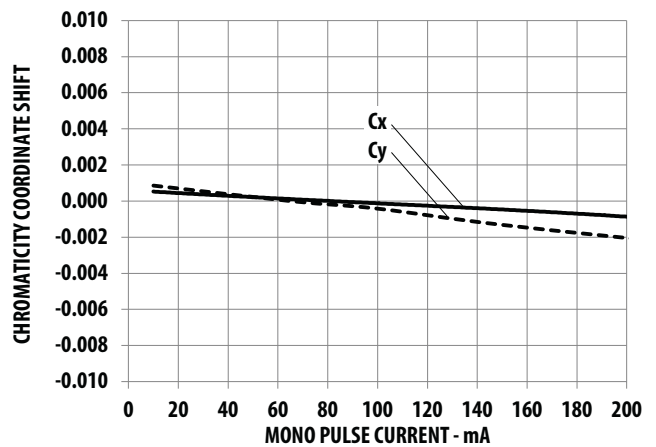

Figure 9 Chromaticity Coordinate Shift vs Forward Current for 6500K

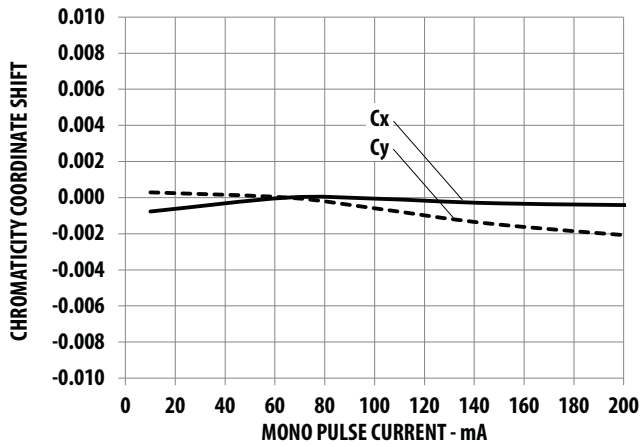

Figure 10 Relative Light Output vs. Junction Temperature

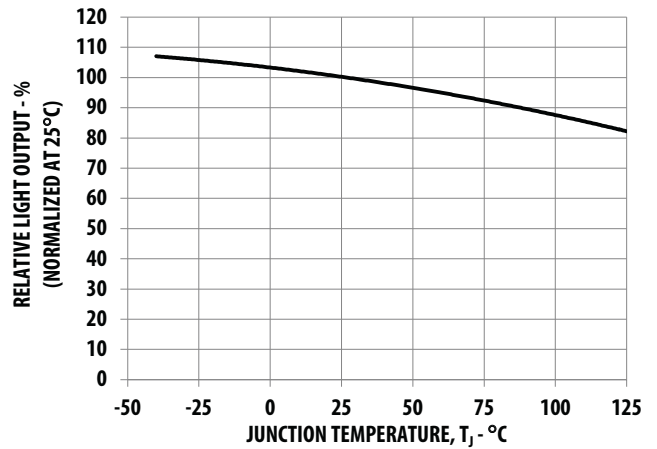

Figure 11 Forward Voltage Shift vs. Junction Temperature

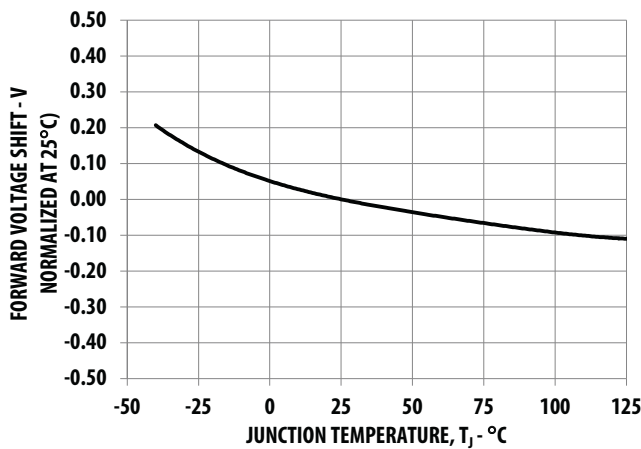

Figure 12 Chromaticity Coordinate Shift vs. Junction Temperature for 3000K

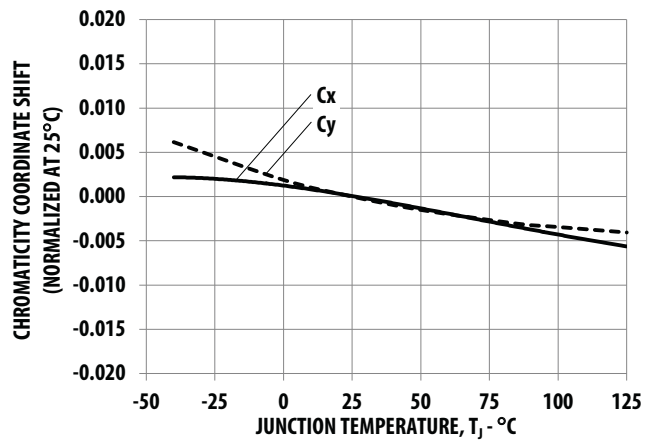

Figure 13 Chromaticity Coordinate Shift vs. Junction Temperature for 4000K

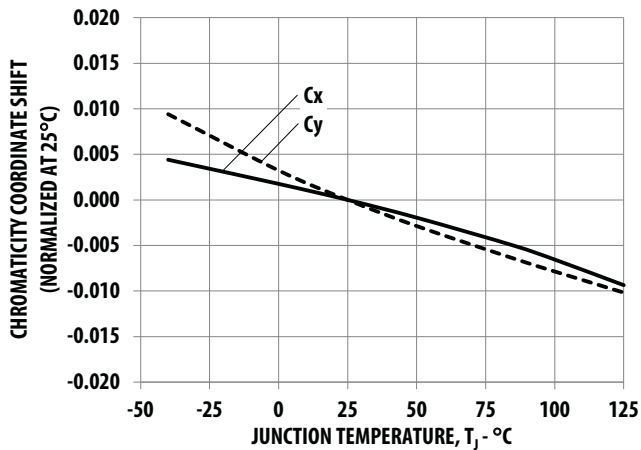

Figure 14 Chromaticity Coordinate Shift vs. Junction Temperature for 6500K

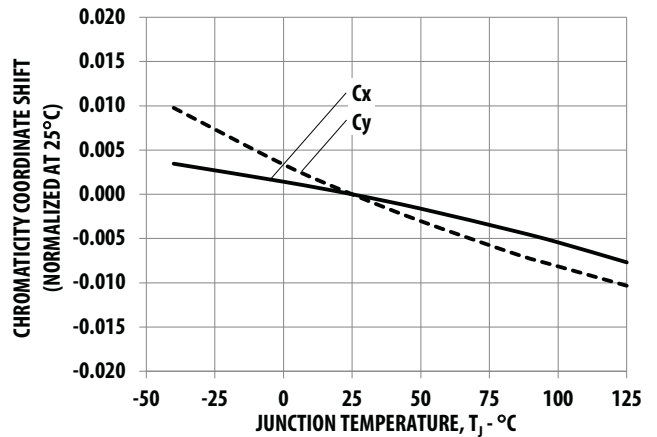

Figure 15 Maximum Forward Current vs. Ambient Temperature. Derated based on $T_{JMAX} = 125^{\circ}C$, $R\theta_{J-A} = 120^{\circ}C/W$, $140^{\circ}C/W$ and $160^{\circ}C/W$.

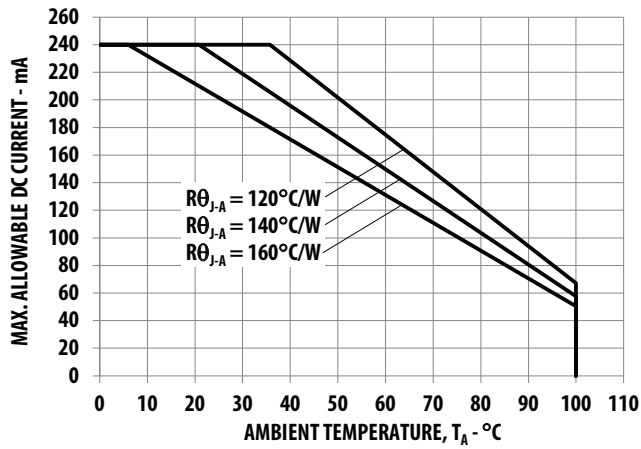

Figure 16 Maximum Forward Current vs. Solder Point Temperature. Derated based on $T_{JMAX} = 125^{\circ}C$, $R\theta_{J-S} = 15^{\circ}C/W$

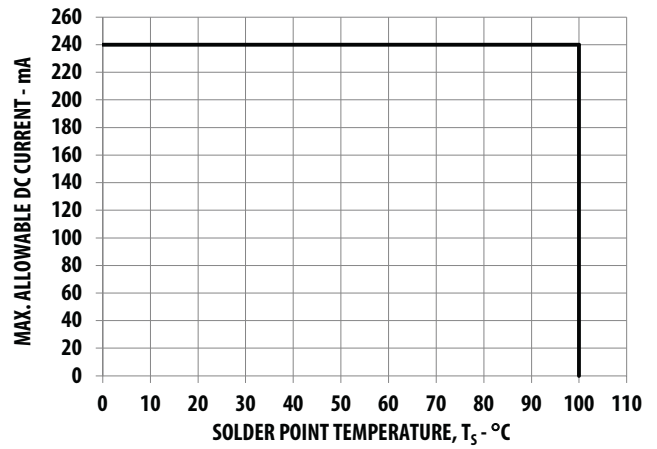
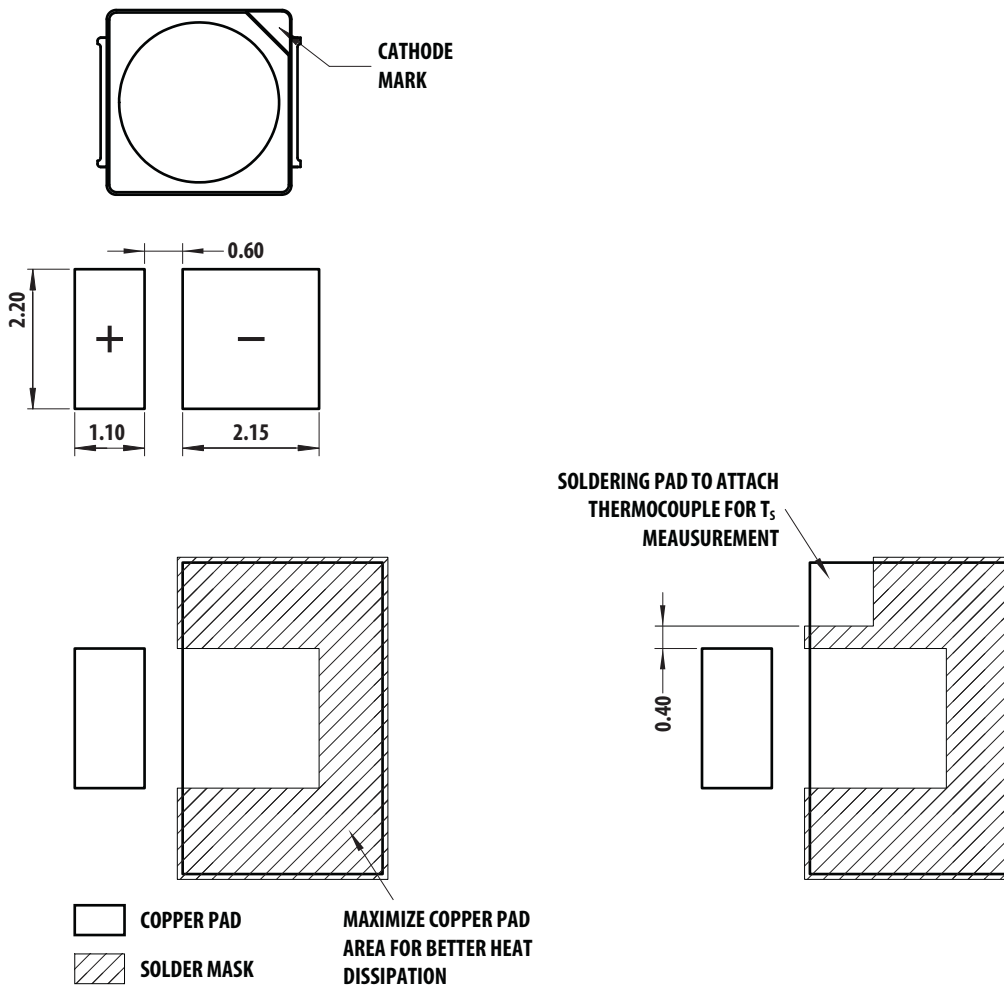

Figure 17 Recommended Soldering Pad Pattern



Precautionary Notes

Soldering

- Do not perform reflow soldering more than twice. Observe necessary precautions of handling moisture-sensitive devices as stated in the following section.
- Do not apply any pressure or force on the LED during reflow and after reflow when the LED is still hot.
- Use reflow soldering to solder the LED. Use hand soldering only for rework if unavoidable, and it must be strictly controlled to the following conditions:
 - Solder iron tip temperature = 315°C max.
 - Solder duration = 3s max.
 - Number of cycles = 1 only
 - Power of soldering iron = 50W max.
- Do not touch the LED package body with the soldering iron except for the soldering terminals, as it may cause damage to the LED
- Confirm beforehand whether the functionality and performance of the LED is affected by soldering with hand soldering.

Figure 20 Recommended Lead-Free Reflow Soldering Profile

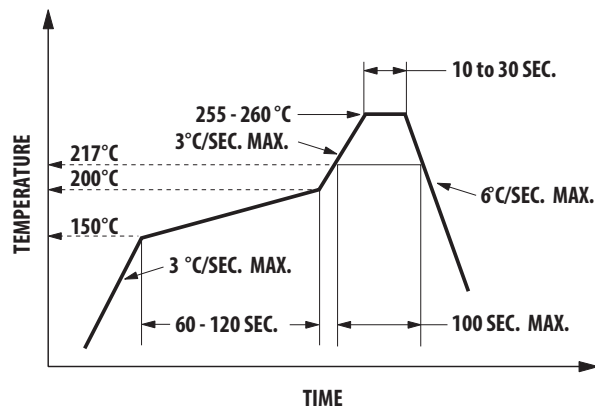

Handling Precautions

The encapsulation material of the LED is made of silicone for better product reliability. Compared to epoxy encapsulant, which is hard and brittle, silicone is softer and flexible. Observe special handling precautions during the assembly of silicone encapsulated LED products. Failure to comply may lead to damage and premature failure of the LED. Refer to Broadcom Application Note AN5288, *Silicone Encapsulation for LED: Advantages and Handling Precautions*, for additional information.

- Do not poke sharp objects into the silicone encapsulant. Sharp objects, such as tweezers or syringes, might apply excessive force or even pierce through the silicone and induce failures to the LED die or wire bond.
- Do not touch the silicone encapsulant. Uncontrolled force acting on the silicone encapsulant might result in excessive stress on the wire bond. Hold the LED only by the body.
- Do not stack assembled PCBs together. Use an appropriate rack to hold the PCBs.
- The surface of silicone material attracts dust and dirt easier than epoxy due to its surface tackiness. To remove foreign particles on the surface of silicone, use a cotton bud with isopropyl alcohol (IPA). During cleaning, rub the surface gently without putting too much pressure on the silicone. Ultrasonic cleaning is not recommended.
- For automated pick and place, Broadcom has tested a nozzle size with OD 1.5 mm to work with this LED. However, due to the possibility of variations in other parameters, such as pick and place, machine maker/model, and other settings of the machine, verify that the selected nozzle will not cause damage to the LED.

Handling of Moisture-Sensitive Devices

This product has a Moisture Sensitive Level 3 rating per JEDEC J-STD-020. Refer to Broadcom Application Note AN5305, *Handling of Moisture Sensitive Surface Mount Devices* for additional details and a review of proper handling procedures.

- Before use:
 - An unopened moisture barrier bag (MBB) can be stored at < 40°C/90% RH for 12 months. If the actual shelf life has exceeded 12 months and the Humidity Indicator Card (HIC) indicates that baking is not required, then it is safe to reflow the LEDs per the original MSL rating.
 - Do not open the MBB prior to assembly (for example, for IQC). If unavoidable, the MBB must be properly resealed with fresh desiccant and HIC. The exposed duration must be taken in as floor life.
- Control after opening the MBB:
 - Read the HIC immediately upon opening of the MBB.
 - Keep the LEDs at < 30°C/60% RH at all times, and complete all high temperature-related processes, including soldering, curing, or rework, within 168 hours.
- Control for the unfinished reel:
 - Store unused LEDs in a sealed MBB with desiccant or desiccator at < 5% RH.

- Control of assembled boards:
If the PCB soldered with the LEDs is to be subjected to other high-temperature processes, store the PCB in a sealed MBB with desiccant or desiccator at < 5% RH to ensure that all LEDs have not exceeded their floor life of 168 hours.
- Baking is required if:
 - The HIC indicator indicates a change in color for 10% and 5%, as stated on the HIC.
 - The LEDs are exposed to conditions of > 30°C/60% RH at any time.
 - The LED's floor life exceeded 168 hours.

The recommended baking condition is: 60°C ± 5°C for 20 hours.

Baking should only be done once.
- Storage:
The soldering terminals of these Broadcom LEDs are silver plated. If the LEDs are exposed in ambient environment for too long, the silver plating might be oxidized, thus affecting its solderability performance. As such, keep unused LEDs in a sealed MBB with desiccant or in desiccator at < 5% RH.

Application Precautions

- The drive current of the LED must not exceed the maximum allowable limit across temperature as stated in the data sheet. Constant current driving is recommended to ensure consistent performance.
 - Circuit design must cater to the whole range of the forward voltage (VF) of the LEDs to ensure the intended drive current can always be achieved.
 - The LED exhibits slightly different characteristics at different drive currents, which may result in a larger variation of performance (meaning: intensity, wavelength, and forward voltage). Set the application current as close as possible to the test current to minimize these variations.
 - The LED is not intended for reverse bias. Use other appropriate components for such purposes. When driving the LED in matrix form, ensure that the reverse bias voltage does not exceed the allowable limit of the LED.
 - Do not use the LED in the vicinity of materials with sulfur content or in environments of high gaseous sulfur compounds and corrosive elements. Examples of materials that might contain sulfur are rubber gaskets, room-temperature vulcanizing (RTV) silicone rubber, rubber gloves, and so on. Prolonged exposure to such environments may affect the optical characteristics and product life.
- White LEDs must not be exposed to acidic environments and must not be used in the vicinity of any compound that may have acidic outgas, such as, but not limited to, acrylate adhesive. These environments have an adverse effect on LED performance.
 - Avoid rapid changes in ambient temperature, especially in high-humidity environments, because they cause condensation on the LED.
 - If the LED is intended to be used in a harsh or outdoor environment, protect the LED against damages caused by rain water, water, dust, oil, corrosive gases, external mechanical stress, and so on.

Thermal Management

The optical, electrical, and reliability characteristics of the LED are affected by temperature. Keep the junction temperature (T_J) of the LED below the allowable limit at all times. T_J can be calculated as follows:

$$T_J = T_A + R_{\theta J-A} \times I_F \times V_{Fmax}$$

where;

T_A = ambient temperature (°C)

$R_{\theta J-A}$ = thermal resistance from LED junction to ambient (°C/W)

I_F = forward current (A)

V_{Fmax} = maximum forward voltage (V)

The complication of using this formula lies in T_A and $R_{\theta J-A}$. Actual T_A is sometimes subjective and hard to determine. $R_{\theta J-A}$ varies from system to system depending on design and is usually not known.

Another way of calculating T_J is by using the solder point temperature, T_S as follows:

$$T_J = T_S + R_{\theta J-S} \times I_F \times V_{Fmax}$$

where;

T_S = LED solder point temperature as shown in the following figure (°C)

$R_{\theta J-S}$ = thermal resistance from junction to solder point (°C/W)

I_F = forward current (A)

V_{Fmax} = maximum forward voltage (V)

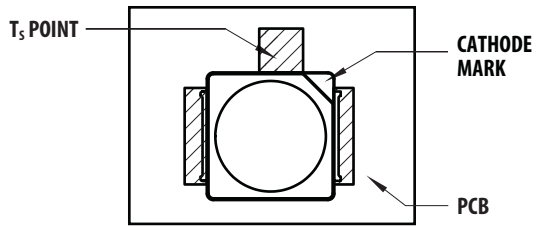
Figure 21 Solder Point Temperature on the PCB

T_S can be easily measured by mounting a thermocouple on the soldering joint as shown in the preceding figure, while $R_{\theta J-S}$ is provided in the data sheet. Verify the T_S of the LED in the final product to ensure that the LEDs are operating within all maximum ratings stated in the data sheet.

Eye Safety Precautions

LEDs may pose optical hazards when in operation. Do not look directly at operating LEDs because it might be harmful to the eyes. For safety reasons, use appropriate shielding or personal protection equipment.

Disclaimer

Broadcom's products and software are not specifically designed, manufactured, or authorized for sale as parts, components, or assemblies for the planning, construction, maintenance, or direct operation of a nuclear facility or for use in medical devices or applications. The customer is solely responsible, and waives all rights to make claims against Broadcom or its suppliers, for all loss, damage, expense, or liability in connection with such use.

For product information and a complete list of distributors, please go to our web site: www.broadcom.com.

Broadcom, the pulse logo, Connecting everything, Avago Technologies, Avago, and the A logo are among the trademarks of Broadcom and/or its affiliates in the United States, certain other countries and/or the EU.

Copyright © 2016 by Broadcom. All Rights Reserved.

The term "Broadcom" refers to Broadcom Limited and/or its subsidiaries. For more information, please visit www.broadcom.com.

Broadcom reserves the right to make changes without further notice to any products or data herein to improve reliability, function, or design.

Information furnished by Broadcom is believed to be accurate and reliable. However, Broadcom does not assume any liability arising out of the application or use of this information, nor the application or use of any product or circuit described herein, neither does it convey any license under its patent rights nor the rights of others.

ASMF-LWG4-NxxxD-DS100 – December 8, 2016

