

# Cree® PLCC4 1 in 1 SMD LED CLM2D-GCC/BCC



## PRODUCT DESCRIPTION

SMD LEDs is packaged in the industry standard package. These LEDs have high reliability performance and are designed to work under a wide range of environmental conditions. This high reliability feature makes them ideally suited to be used under Architectural lighting application conditions

These LEDs are suited for channel letter, or Architectural lighting applications. Cree has been certified in accordance with ISO/ IATF16949.

## FEATURES

- Size (mm): 3.2 x 2.8
- Color and Typical Dominant Wavelength:  
Green (520-535nm)  
Blue (465 - 475nm)
- Luminous Intensity (mcd)  
CLM2D-GCC: (7100 - 22400)  
CLM2D-BCC: (1400 - 4500)
- Moisture Sensitivity Level: 5a
- Lead-Free
- RoHS Compliant
- Untinted Diffused Lens

## APPLICATIONS

- Channel Letter
- Architectural Lighting

### ABSOLUTE MAXIMUM RATINGS ( $T_A = 25^\circ\text{C}$ )

Items	Symbol	Absolute Maximum Rating		Unit
		Green	Blue	
Forward Current	$I_F$	35		mA
Peak Forward Current <sup>Note</sup>	$I_{FP}$	100		mA
Reverse Voltage	$V_R$	5		V
Power Dissipation	$P_D$	140		mW
Operation Temperature	$T_{opr}$	-40 ~ +100		$^\circ\text{C}$
Storage Temperature	$T_{stg}$	-40 ~ +100		$^\circ\text{C}$
Junction Temperature	$T_j$	110		$^\circ\text{C}$
Junction/Ambient	$R_{THJA}$	450	320	$^\circ\text{C}/\text{W}$
Junction/Solder Point	$R_{THJS}$	220	150	$^\circ\text{C}/\text{W}$
Electrostatic Discharge Classification(MIL-STD-883E)	ESD	1000V		

**Note:** Pulse width  $\leq 0.1$  msec, duty  $\leq 1/10$ .

### TYPICAL ELECTRICAL & OPTICAL CHARACTERISTICS ( $T_A = 25^\circ\text{C}$ )

Characteristics	Color	Symbol	Condition	Unit	Minimum	Typical	Maximum
Forward Voltage	Green	$V_F$	$I_F = 20$ mA	V		2.9	4.0
	Blue					3.1	4.0
Reverse Current	Green/Blue	$I_R$	$V_R = 5$ V	$\mu\text{A}$			10
Dominant Wavelength	Green	$\lambda_D$	$I_F = 20$ mA	nm	520	527.5	535
	Blue	$\lambda_D$	$I_F = 20$ mA	nm	465	470	475
Luminous Intensity	Green	$I_V$	$I_F = 20$ mA	mcd	7100	12000	
	Blue	$I_V$	$I_F = 20$ mA	mcd	1400	2300	

**Note:** Continuous reverse voltage can cause LED damage.

### INTENSITY BIN LIMIT ( $I_F = 20 \text{ mA}$ )

Green (CLM2D-GCC)

Bin Code	Min. (mcd)	Max. (mcd)
B0	7100	9000
C0	9000	11200
D0	11200	14000
E0	14000	18000
F0	18000	22400

Blue (CLM2D-BCC)

Bin Code	Min. (mcd)	Max. (mcd)
Wb	1400	1800
Xa	1800	2240
Xb	2240	2800
Ya	2800	3550
Yb	3550	4500

Tolerance of measurement of luminous intensity is  $\pm 10\%$ .

### COLOR BIN LIMIT ( $I_F = 20 \text{ mA}$ )

Green (CLM2D-GCC)

Bin Code	Min. (nm)	Max. (nm)
G7	520	525
G23	522.5	527.5
G8	525	530
G45	527.5	532.5
G9	530	535

Blue (CLM2D-BCC)

Bin Code	Min. (nm)	Max. (nm)
B4	465	470
B45	467.5	472.5
B5	470	475

Tolerance of measurement of dominant wavelength is  $\pm 1 \text{ nm}$ .

### ORDER CODE TABLE\*

Color	Kit Number	Luminous Intensity (mcd)		Dominant Wavelength				Package
		Min.	Max.	Color Bin	Min.(nm)	Color Bin	Max.(nm)	
Green	CLM2D-GCC-CB0F0793	7100	22400	G7	520	G9	535	Reel
Green	CLM2D-GCC-CC0F0793	9000	22400	G7	520	G9	535	Reel
Green	CLM2D-GCC-CC0F0783	9000	22400	G7	520	G8	530	Reel

Color	Kit Number	Luminous Intensity (mcd)		Dominant Wavelength				Package
		Min.	Max.	Color Bin	Min.(nm)	Color Bin	Max.(nm)	
Blue	CLM2D-BCC-CWbYb453	1400	4500	B4	465	B5	475	Reel
Blue	CLM2D-BCC-CXaYb453	1800	4500	B4	465	B5	475	Reel

Notes:

1. The above kit numbers represent order codes that include multiple intensity-bin and color-bin codes. Only one intensity-bin code and one color-bin code will be shipped on each bulk. Single intensity-bin code and single color-bin codes will not be orderable.
2. Please refer to the "Cree LED Lamp Reliability Test Standards" document #1 for reliability test conditions.
3. Please refer to the "Cree LED Lamp Soldering & Handling" document #2 for information about how to use this LED product safely.

#1: Refer to [http://www.cree.com/led-components/media/documents/LED\\_Lamp\\_Reliability\\_Test\\_Standard.pdf](http://www.cree.com/led-components/media/documents/LED_Lamp_Reliability_Test_Standard.pdf)

#2: Refer to <http://www.cree.com/led-components/media/documents/sh-HB.pdf>

## GRAPHS

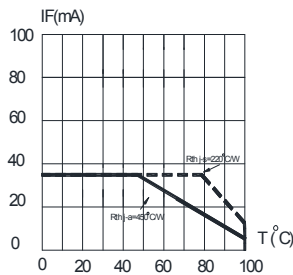
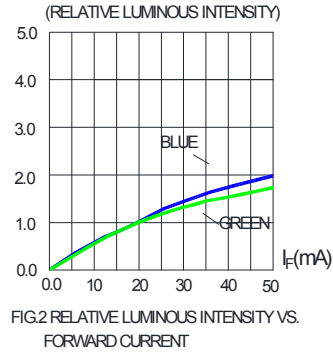
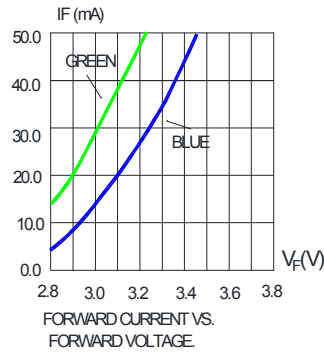

FIG.5 Green MAXIMUM FORWARD DC CURRENT VS AMBIENT TEMPERATURE (Tjmax=110°C)

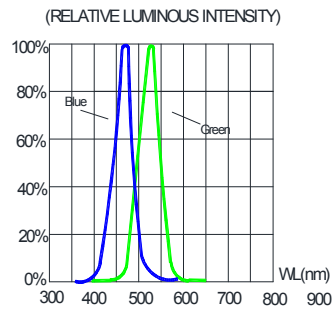

FIG.4 RELATIVE LUMINOUS INTENSITY VS. WAVELENGTH.

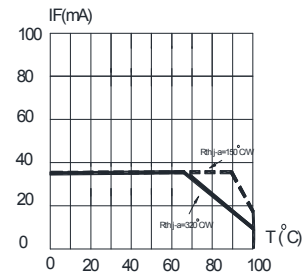

FIG.5 Blue MAXIMUM FORWARD DC CURRENT VS AMBIENT TEMPERATURE (Tjmax=110°C)

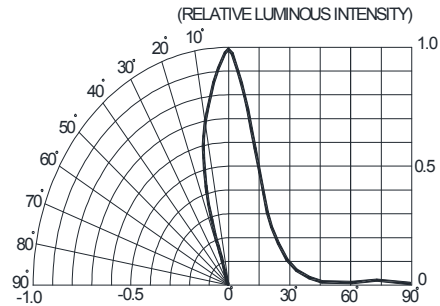
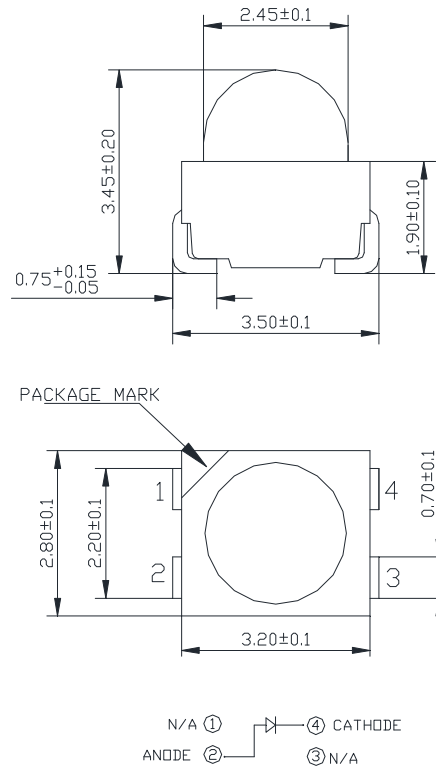

FIG.6 FAR FIELD PATTERN

The above data are collected from statistical figures that do not necessarily correspond to the actual parameters of each single LED. Hence, these data will be changed without further notice.

## MECHANICAL DIMENSIONS

All dimensions are in mm.



## NOTES

### RoHS Compliance

The levels of RoHS-restricted materials in this product are below the maximum concentration values (also referred to as the threshold limits) permitted for such substances, or are used in an exempted application in accordance with EU Directive 2011/65/EC (RoHS2), as implemented by EU member states on January 2, 2013 and amended on March 31, 2015 by EU Directive 2015/863/EU.

RoHS Declarations for this product can be obtained from your Cree representative or from the Product Ecology section of the Cree website.

### Vision Advisory Claim

Users should be cautioned not to stare at the light of this LED product. The bright light can damage the eye.

## KIT NUMBER SYSTEM

Cree LED lamps are tested and sorted into performance bins. A bin is specified by ranges of color, forward voltage, and brightness. Sorted LEDs are packaged for shipping in various convenient options. Please refer to the "Cree LED Lamp Packaging Standard" document for more information about shipping and packaging options.

Cree LEDs are sold by order codes in combinations of bins called kits. Order codes are configured in the following manner:



## REFLOW SOLDERING

- The CLM2D-GCC/BCC is rated as a MSL 5a product.
- The recommended floor life out of bag is 24hrs.
- The temperature profile is as below.



Use only with CLM2D-GCC/BCC

Solder
Average ramp-up rate = 4°C/s max
Preheat temperature = 150°C ~200°C
Preheat time = 120s max
Ramp-down rate = 6°C/s max
Peak temperature = 235°C max
Time within 5°C of actual Peak Temperature = 10s max
Duration above 217°C is 45s max

Refer to "<http://www.cree.com/led-components/media/documents/sh-HB.pdf>" for soldering & handling details.



## NOTES

---

- The packaging sizes of these SMD products are very small and the resin is still soft after solidification. Users are required to handle with care. Never touch the resin surface of SMD products.
- To avoid damaging the product's surface and interior device, it is recommended to choose a special nozzle to pick up the SMD products during the process of SMT production. If handling is necessary, take special care when picking up these products. The following method is necessary:



## PACKAGING

- The boxes are not water resistant and they must be kept away from water and moisture.
- The LEDs are packed in cardboard boxes after packaging in normal or anti-electrostatic bags.
- Cardboard boxes will be used to protect the LEDs from mechanical shocks during transportation.
- The reel pack is applied in SMD LED.
- Max 2300 pcs per reel.

