

IP4251/52/53/54-TTL

Integrated 4-, 6- and 8-channel passive filter network
with ESD protection

Rev. 2 — 5 May 2011

Product data sheet

1. Product profile

1.1 General description

The devices are 4-, 6- and 8-channel RC low-pass filter arrays which are designed to provide filtering of undesired RF signals on the I/O ports of portable communication or computing devices. In addition, the devices incorporate diodes to provide protection to downstream components from ElectroStatic Discharge (ESD) voltages as high as ± 30 kV.

The devices are fabricated using monolithic silicon technology and integrate up to eight resistors and sixteen diodes in a 0.4 mm pitch 8-, 12- or 16-pin ultra-thin leadless Quad Flat No-leads (QFN) plastic package with a height of 0.55 mm only.

1.2 Features and benefits

- Pb-free, Restriction of Hazardous Substances (RoHS) compliant and free of halogen and antimony (Dark Green compliant)
- 4-, 6- and 8-channel integrated π -type RC filter network
- ESD protection to ± 30 kV contact discharge according to IEC 61000-4-2 far exceeding level 4
- QFN plastic package with 0.4 mm pitch and 0.55 mm height

1.3 Applications

General-purpose ElectroMagnetic Interference (EMI) and Radio-Frequency Interference (RFI) filtering and downstream ESD protection for:

- Cellular phone and Personal Communication System (PCS) mobile handsets
- Cordless telephones
- Wireless data (WAN/LAN) systems
- Mobile Internet Devices (MID)
- Portable Media Players (PMP)

1.4 Quick reference data

Table 1. Quick reference data

Symbol	Parameter	Conditions	Min	Typ	Max	Unit
IP4251CZ8-4-TTL; IP4251CZ12-6-TTL; IP4251CZ16-8-TTL						
C_{ch}	channel capacitance	$f = 100 \text{ kHz};$ $V_{bias(DC)} = 2.5 \text{ V}$	[1] -	10	-	pF
$R_{s(ch)}$	channel series resistance		80	100	120	Ω
IP4252CZ8-4-TTL; IP4252CZ12-6-TTL; IP4252CZ16-8-TTL						
C_{ch}	channel capacitance	$f = 100 \text{ kHz};$ $V_{bias(DC)} = 2.5 \text{ V}$	[1] -	12	-	pF
$R_{s(ch)}$	channel series resistance		32	40	48	Ω
IP4253CZ8-4-TTL; IP4253CZ12-6-TTL; IP4253CZ16-8-TTL						
C_{ch}	channel capacitance	$f = 100 \text{ kHz};$ $V_{bias(DC)} = 2.5 \text{ V}$	[1] -	30	-	pF
$R_{s(ch)}$	channel series resistance		160	200	240	Ω
IP4254CZ8-4-TTL; IP4254CZ12-6-TTL; IP4254CZ16-8-TTL						
C_{ch}	channel capacitance	$f = 100 \text{ kHz};$ $V_{bias(DC)} = 2.5 \text{ V}$	[1] -	30	-	pF
$R_{s(ch)}$	channel series resistance		80	100	120	Ω

[1] For the total channel.

2. Pinning information

Table 2. Pinning

Pin	Description	Simplified outline	Graphic symbol
IP4251CZ8-4-TTL; IP4252CZ8-4-TTL; IP4253CZ8-4-TTL; IP4254CZ8-4-TTL (SOT1166-1)			
1 and 8	filter channel 1	<p>Transparent top view</p>	<p>018aaa071</p>
2 and 7	filter channel 2		
3 and 6	filter channel 3		
4 and 5	filter channel 4		
ground pad	ground		
IP4251CZ12-6-TTL; IP4252CZ12-6-TTL; IP4253CZ12-6-TTL; IP4254CZ12-6-TTL (SOT1167-1)			
1 and 12	filter channel 1	<p>Transparent top view</p>	<p>018aaa072</p>
2 and 11	filter channel 2		
3 and 10	filter channel 3		
4 and 9	filter channel 4		
5 and 8	filter channel 5		
6 and 7	filter channel 6		
ground pad	ground		

Table 2. Pinning ...continued

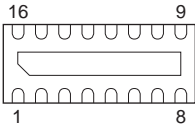
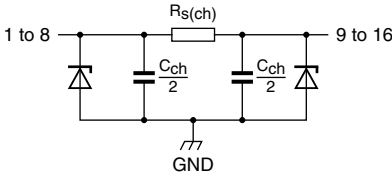
Pin	Description	Simplified outline	Graphic symbol
IP4251CZ16-8-TTL; IP4252CZ16-8-TTL; IP4253CZ16-8-TTL; IP4254CZ16-8-TTL (SOT1168-1)			
1 and 16	filter channel 1	 <p>Transparent top view</p>	
2 and 15	filter channel 2		
3 and 14	filter channel 3		
4 and 13	filter channel 4		
5 and 12	filter channel 5		
6 and 11	filter channel 6		
7 and 10	filter channel 7		
8 and 9	filter channel 8		
ground pad	ground		

018aaa073

3. Ordering information

Table 3. Ordering information

Type number	Package		Version
	Name	Description	
IP4251CZ8-4-TTL	HUSON8	plastic, thermal enhanced ultra thin small outline package; no leads; 8 terminals; body 1.35 × 1.7 × 0.55 mm	SOT1166-1
IP4251CZ12-6-TTL	HUSON12	plastic, thermal enhanced ultra thin small outline package; no leads; 12 terminals; body 1.35 × 2.5 × 0.55 mm	SOT1167-1
IP4251CZ16-8-TTL	HUSON16	plastic, thermal enhanced ultra thin small outline package; no leads; 16 terminals; body 1.35 × 3.3 × 0.55 mm	SOT1168-1
IP4252CZ8-4-TTL	HUSON8	plastic, thermal enhanced ultra thin small outline package; no leads; 8 terminals; body 1.35 × 1.7 × 0.55 mm	SOT1166-1
IP4252CZ12-6-TTL	HUSON12	plastic, thermal enhanced ultra thin small outline package; no leads; 12 terminals; body 1.35 × 2.5 × 0.55 mm	SOT1167-1
IP4252CZ16-8-TTL	HUSON16	plastic, thermal enhanced ultra thin small outline package; no leads; 16 terminals; body 1.35 × 3.3 × 0.55 mm	SOT1168-1
IP4253CZ8-4-TTL	HUSON8	plastic, thermal enhanced ultra thin small outline package; no leads; 8 terminals; body 1.35 × 1.7 × 0.55 mm	SOT1166-1
IP4253CZ12-6-TTL	HUSON12	plastic, thermal enhanced ultra thin small outline package; no leads; 12 terminals; body 1.35 × 2.5 × 0.55 mm	SOT1167-1
IP4253CZ16-8-TTL	HUSON16	plastic, thermal enhanced ultra thin small outline package; no leads; 16 terminals; body 1.35 × 3.3 × 0.55 mm	SOT1168-1
IP4254CZ8-4-TTL	HUSON8	plastic, thermal enhanced ultra thin small outline package; no leads; 8 terminals; body 1.35 × 1.7 × 0.55 mm	SOT1166-1
IP4254CZ12-6-TTL	HUSON12	plastic, thermal enhanced ultra thin small outline package; no leads; 12 terminals; body 1.35 × 2.5 × 0.55 mm	SOT1167-1
IP4254CZ16-8-TTL	HUSON16	plastic, thermal enhanced ultra thin small outline package; no leads; 16 terminals; body 1.35 × 3.3 × 0.55 mm	SOT1168-1

4. Limiting values

Table 4. Limiting values

In accordance with the Absolute Maximum Rating System (IEC 60134).

Symbol	Parameter	Conditions	Min	Max	Unit
IP4251CZ8-4-TTL; IP4251CZ12-6-TTL; IP4251CZ16-8-TTL					
V _{ESD}	electrostatic discharge voltage	all pins to ground; contact discharge	[1] -	±15	kV
IP4252CZ8-4-TTL; IP4252CZ12-6-TTL; IP4252CZ16-8-TTL					
V _{ESD}	electrostatic discharge voltage	all pins to ground; contact discharge	[1] -	±15	kV
IP4253CZ8-4-TTL; IP4253CZ12-6-TTL; IP4253CZ16-8-TTL					
V _{ESD}	electrostatic discharge voltage	all pins to ground	[2]		
		contact discharge	-	±30	kV
		air discharge	-	±30	kV
IP4254CZ8-4-TTL; IP4254CZ12-6-TTL; IP4254CZ16-8-TTL					
V _{ESD}	electrostatic discharge voltage	all pins to ground	[2]		
		contact discharge	-	±30	kV
		air discharge	-	±30	kV
Per device					
V _{ESD}	electrostatic discharge voltage	IEC 61000-4-2, level 4; all pins to ground			
		contact discharge	-	±8	kV
		air discharge	-	±15	kV
V _{CC}	supply voltage		-0.5	+5.6	V
P _{ch}	channel power dissipation	T _{amb} = 85 °C	-	60	mW
P _{tot}	total power dissipation	T _{amb} = 85 °C	-	200	mW
T _{stg}	storage temperature		-55	+150	°C
T _{amb}	ambient temperature		-40	+85	°C

[1] Device tested with 1000 pulses of ±15 kV contact discharges, according to the IEC 61000-4-2 model, far exceeding IEC 61000-4-2 level 4 (8 kV contact discharge).

[2] Device tested with 1000 pulses of ±30 kV contact discharges, according to the IEC 61000-4-2 model, far exceeding IEC 61000-4-2 level 4 (8 kV contact discharge).

5. Characteristics

Table 5. Channel characteristics

$T_{amb} = 25\text{ °C}$ unless otherwise specified.

Symbol	Parameter	Conditions	Min	Typ	Max	Unit
IP4251CZ8-4-TTL; IP4251CZ12-6-TTL; IP4251CZ16-8-TTL						
C_{ch}	channel capacitance	$f = 100\text{ kHz}$	[1]			
		$V_{bias(DC)} = 2.5\text{ V}$	-	10	-	pF
		$V_{bias(DC)} = 0\text{ V}$	[2]	-	15	-
$R_{s(ch)}$	channel series resistance		80	100	120	Ω
IP4252CZ8-4-TTL; IP4252CZ12-6-TTL; IP4252CZ16-8-TTL						
C_{ch}	channel capacitance	$f = 100\text{ kHz}$	[1]			
		$V_{bias(DC)} = 2.5\text{ V}$	-	12	-	pF
		$V_{bias(DC)} = 0\text{ V}$	[2]	-	18	-
$R_{s(ch)}$	channel series resistance		32	40	48	Ω
IP4253CZ8-4-TTL; IP4253CZ12-6-TTL; IP4253CZ16-8-TTL						
C_{ch}	channel capacitance	$f = 100\text{ kHz}$	[1]			
		$V_{bias(DC)} = 2.5\text{ V}$	-	30	-	pF
		$V_{bias(DC)} = 0\text{ V}$	[2]	-	45	-
$R_{s(ch)}$	channel series resistance		160	200	240	Ω
IP4254CZ8-4-TTL; IP4254CZ12-6-TTL; IP4254CZ16-8-TTL						
C_{ch}	channel capacitance	$f = 100\text{ kHz}$	[1]			
		$V_{bias(DC)} = 2.5\text{ V}$	-	30	-	pF
		$V_{bias(DC)} = 0\text{ V}$	[2]	-	45	-
$R_{s(ch)}$	channel series resistance		80	100	120	Ω
Per device						
I_{LR}	reverse leakage current	per channel; $V_I = 3.5\text{ V}$	-	-	0.1	μA
V_{BR}	breakdown voltage	positive clamp; $I_I = 1\text{ mA}$	5.8	-	9	V
V_F	forward voltage	negative clamp; $I_F = 1\text{ mA}$	0.4	-	1.5	V

[1] For the total channel.

[2] Guaranteed by design.

Table 6. Frequency characteristics*T_{amb} = 25 °C unless otherwise specified.*

Symbol	Parameter	Conditions	Min	Typ	Max	Unit
IP4251CZ8-4-TTL; IP4251CZ12-6-TTL; IP4251CZ16-8-TTL						
α_{il}	insertion loss	$R_{source} = 50 \Omega$; $R_L = 50 \Omega$				
		800 MHz < f < 3 GHz	-	16	-	dB
		f = 1 GHz	-	20	-	dB
α_{ct}	crosstalk attenuation	$R_{source} = 50 \Omega$; $R_L = 50 \Omega$; 800 MHz < f < 3 GHz	-	30	-	dB
IP4252CZ8-4-TTL; IP4252CZ12-6-TTL; IP4252CZ16-8-TTL						
α_{il}	insertion loss	$R_{source} = 50 \Omega$; $R_L = 50 \Omega$				
		800 MHz < f < 3 GHz	-	12	-	dB
		f = 1 GHz	-	14	-	dB
α_{ct}	crosstalk attenuation	$R_{source} = 50 \Omega$; $R_L = 50 \Omega$; 800 MHz < f < 3 GHz	-	40	-	dB
IP4253CZ8-4-TTL; IP4253CZ12-6-TTL; IP4253CZ16-8-TTL						
α_{il}	insertion loss	$R_{source} = 50 \Omega$; $R_L = 50 \Omega$				
		800 MHz < f < 3 GHz	-	33	-	dB
		f = 1 GHz	35	-	-	dB
α_{ct}	crosstalk attenuation	$R_{source} = 50 \Omega$; $R_L = 50 \Omega$; 800 MHz < f < 3 GHz	-	30	-	dB
IP4254CZ8-4-TTL; IP4254CZ12-6-TTL; IP4254CZ16-8-TTL						
α_{il}	insertion loss	$R_{source} = 50 \Omega$; $R_L = 50 \Omega$				
		800 MHz < f < 3 GHz	-	28	-	dB
		f = 1 GHz	30	-	-	dB
α_{ct}	crosstalk attenuation	$R_{source} = 50 \Omega$; $R_L = 50 \Omega$; 800 MHz < f < 3 GHz	-	30	-	dB

6. Application information

6.1 Insertion loss

The devices are designed as EMI/RFI filters for multichannel interfaces.

The block schematic for measuring insertion loss in a 50 Ω system is shown in [Figure 1](#). Typical measurements results are shown in [Figure 2](#) to [Figure 6](#) for the different devices.

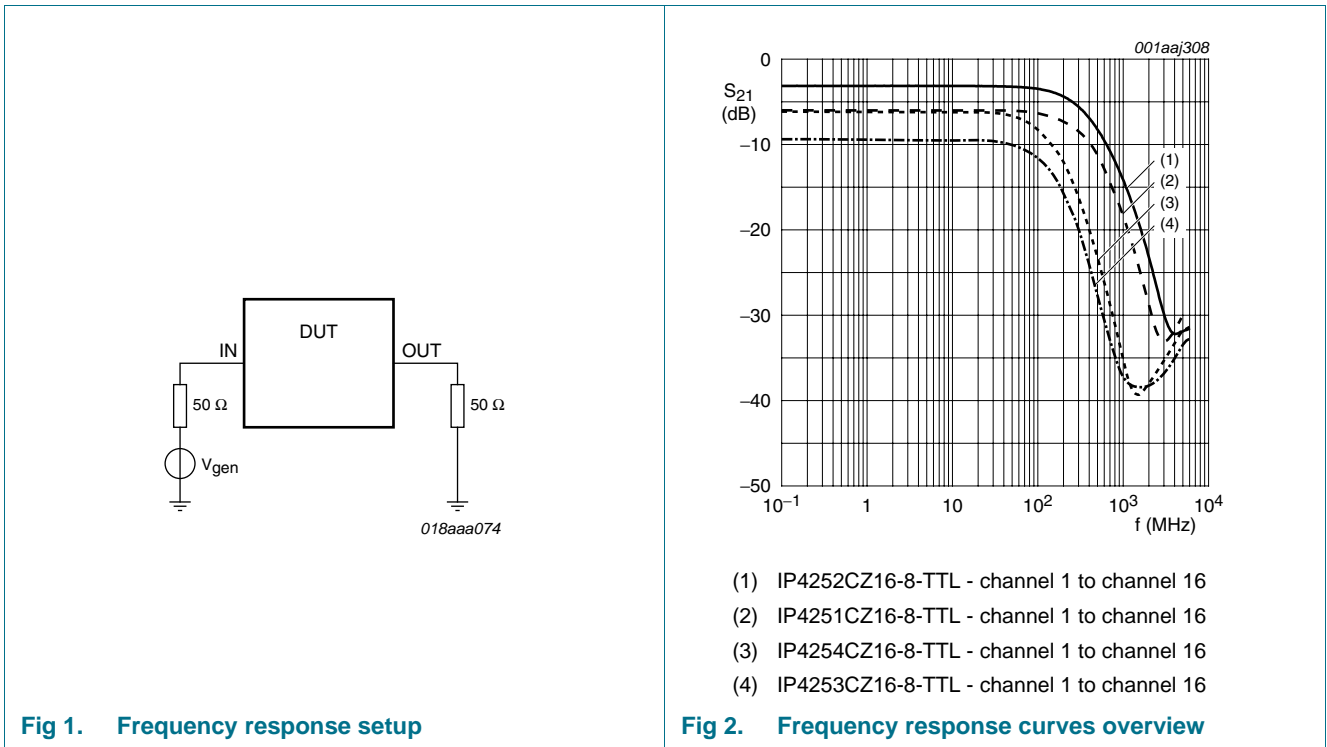
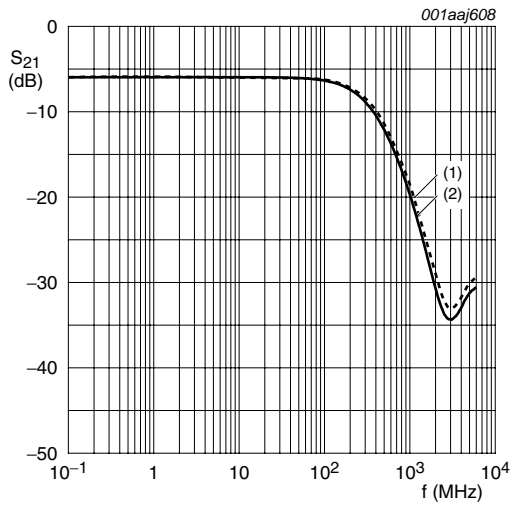

Fig 1. Frequency response setup

Fig 2. Frequency response curves overview



- (1) Channel 1 to channel 16
- (2) Channel 4 to channel 13

Fig 3. IP4251CZ16-8-TTL: frequency response curves

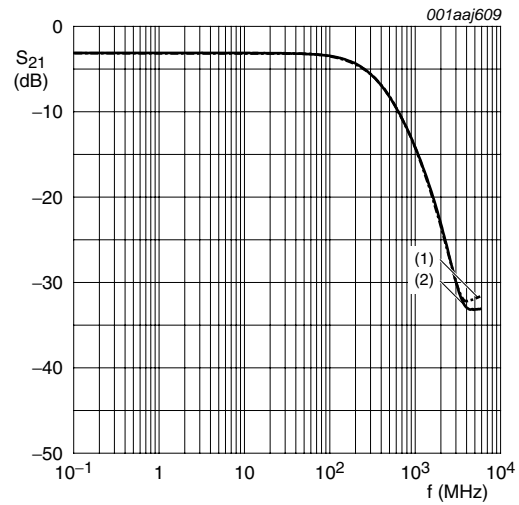

- (1) Channel 1 to channel 16
- (2) Channel 4 to channel 13

Fig 4. IP4252CZ16-8-TTL: frequency response curves

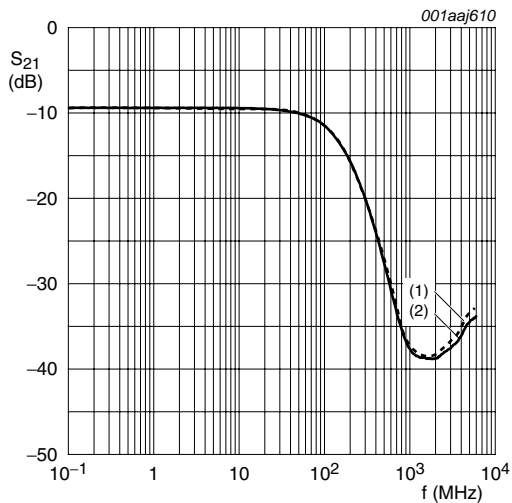

- (1) Channel 1 to channel 16
- (2) Channel 4 to channel 13

Fig 5. IP4253CZ16-8-TTL: frequency response curves

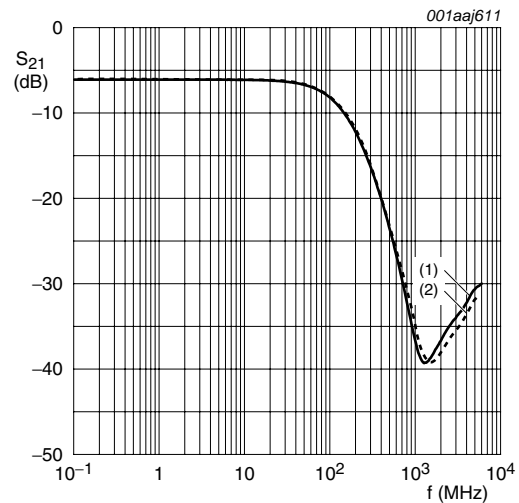

- (1) Channel 4 to channel 13
- (2) Channel 1 to channel 16

Fig 6. IP4254CZ16-8-TTL: frequency response curves

Due to the optimized silicon dice and package design, all channels in a single package show a very good matching performance as the insertion loss for a channel at the package side (e.g. channel 1 to channel 16) is nearly identical with the center channels (e.g. channel 4 to channel 13).

6.2 Selection

The selection of one of the filter devices has to be performed depending on the maximum clock frequency, driver strength, capacitive load of the sink, and also the maximum applicable rise and fall times.

6.2.1 SDHC and MMC memory interface

The Secure Digital High Capacity (SDHC) memory card interface standard specification and the Multi Media Card (MMC) (JESD 84A43) standard specification recommend a rise and fall time of 25 % to 62.5 % (62.5 % to 25 % respectively) of 3 ns or less for the input signal of the receiving interface side.

Assuming a typical capacitance of about 20 pF for the SDHC memory card itself, and approximately 4 pF to 7 pF for the Printed-Circuit Board (PCB) and the card holder, IP4252CZ12-6-TTL (6 channels, $R_{S(ch)} = 40 \Omega$, $C_{ch} = 12 \text{ pF}$ at $V_{bias(DC)} = 2.5 \text{ V}$) is a matching selection to filter and protect all relevant interface pins such as CLK, CMD, and DAT0 to DAT3/CD. Please refer to [Figure 7](#) for a general example of the implementation of the device in an SDHC card interface.

In case additional channels such as write-protect or a mechanical card-detection switch are used, the IP4252CZ16-8-TTL (8 channels, $R_{S(ch)} = 40 \Omega$, $C_{ch} = 12 \text{ pF}$ at $V_{bias(DC)} = 2.5 \text{ V}$) offers two additional channels.



Fig 7. Example of IP4252 in an SDHC card interface

The capacitance values specified for the signal channels of the MMC interface differ from the SDHC specification. The MMC card-side interface is specified to have an intrinsic capacitance of 12 pF to 18 pF and the total channel is limited according to the specification to 30 pF only. Therefore, any filter device capacitance is limited to a maximum of up to 18 pF, including the card holder and PCB traces.

Please refer to [Figure 8](#) for a general example of the implementation of the IP4252 in an MMC interface application.

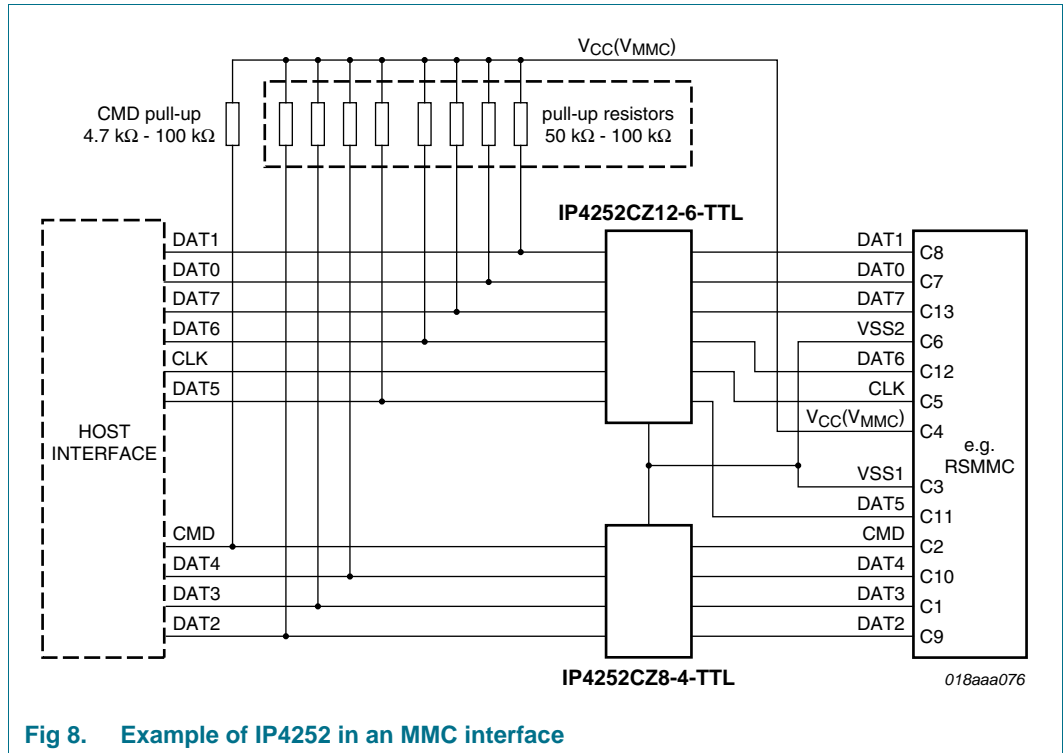

Fig 8. Example of IP4252 in an MMC interface

To generate SDHC and MMC-compliant digital signals, the driver strength should not significantly undercut 8 mA.

6.2.2 LCD interfaces, medium-speed interfaces

For digital interfaces such as LCD interfaces running at clock speeds between 10 MHz and 25 MHz or more, IP4251, IP4252 or IP4254 can be used depending on the sink load, clock speed, driver strength and rise and fall time requirements. Also the minimum EMI filter requirements may be a decision-making factor.

6.2.3 Keypad, low-speed interfaces

Especially for lower-speed interfaces such as keypads, low-speed serial interfaces (e.g. Recommended Standard (RS) 232) and low-speed control signals, IP4253 ($R_{S(ch)} = 200 \Omega$, $C_{ch} = 30 \text{ pF}$ at $V_{bias(DC)} = 2.5 \text{ V}$) offers a very robust ESD protection and strong suppression of unwanted frequencies (EMI filtering).

7. Package outline

HUSON8: plastic, thermal enhanced ultra thin small outline package; no leads; 8 terminals; body 1.35 x 1.7 x 0.55 mm

SOT1166-1

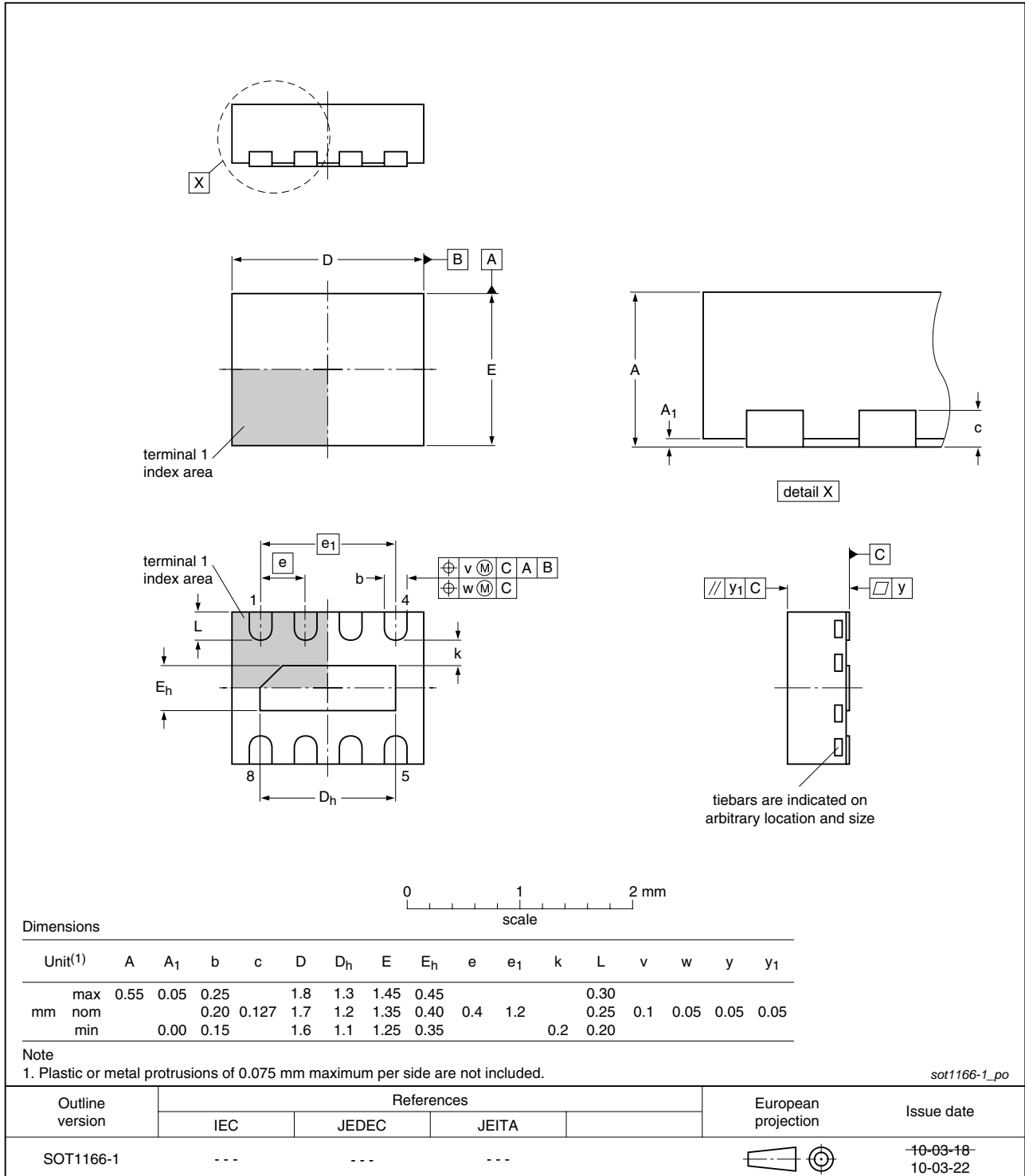

Fig 9. Package outline SOT1166-1 (HUSON8)

HUSON12: plastic, thermal enhanced ultra thin small outline package; no leads; 12 terminals; body 1.35 x 2.5 x 0.55 mm

SOT1167-1

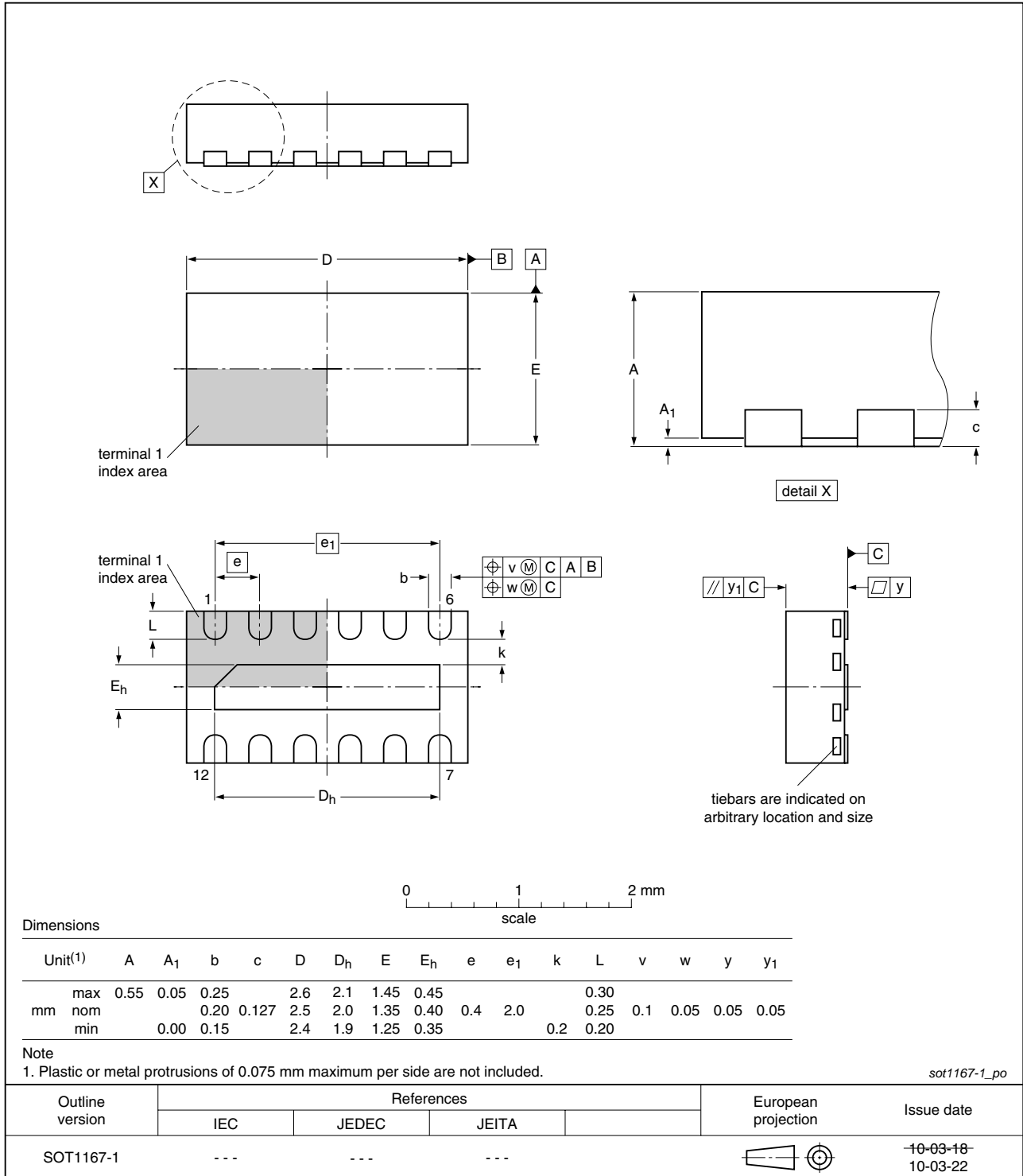

Fig 10. Package outline SOT1167-1 (HUSON12)

HUSON16: plastic, thermal enhanced ultra thin small outline package; no leads;
16 terminals; body 1.35 x 3.3 x 0.55 mm

SOT1168-1

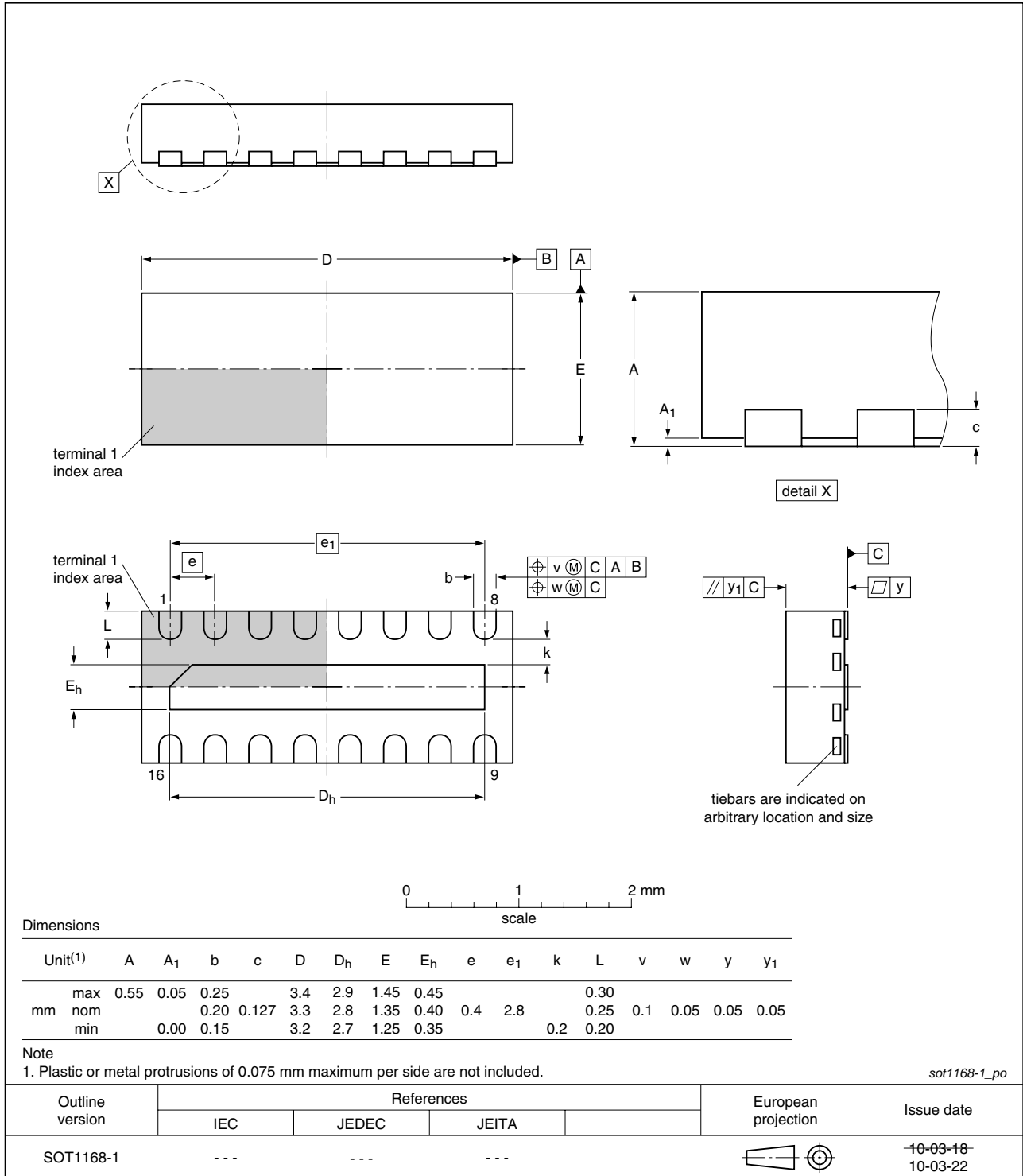

Fig 11. Package outline SOT1168-1 (HUSON16)

8. Revision history

Table 7. Revision history

Document ID	Release date	Data sheet status	Change notice	Supersedes
IP4251_52_53_54-TTL v.2	20110505	Product data sheet	-	IP4251_52_53_54-TTL v.1
Modifications:		<ul style="list-style-type: none">• Section 1 “Product profile”: updated.• Table 2 “Pinning”: updated.• Deleted section “Thermal characteristics”.		
IP4251_52_53_54-TTL v.1	20110131	Objective data sheet	-	-

9. Legal information

9.1 Data sheet status

Document status ^{[1][2]}	Product status ^[3]	Definition
Objective [short] data sheet	Development	This document contains data from the objective specification for product development.
Preliminary [short] data sheet	Qualification	This document contains data from the preliminary specification.
Product [short] data sheet	Production	This document contains the product specification.

[1] Please consult the most recently issued document before initiating or completing a design.

[2] The term 'short data sheet' is explained in section "Definitions".

[3] The product status of device(s) described in this document may have changed since this document was published and may differ in case of multiple devices. The latest product status information is available on the Internet at URL <http://www.nexperia.com>.

9.2 Definitions

Draft — The document is a draft version only. The content is still under internal review and subject to formal approval, which may result in modifications or additions. Nexperia does not give any representations or warranties as to the accuracy or completeness of information included herein and shall have no liability for the consequences of use of such information.

Short data sheet — A short data sheet is an extract from a full data sheet with the same product type number(s) and title. A short data sheet is intended for quick reference only and should not be relied upon to contain detailed and full information. For detailed and full information see the relevant full data sheet, which is available on request via the local Nexperia sales office. In case of any inconsistency or conflict with the short data sheet, the full data sheet shall prevail.

Product specification — The information and data provided in a Product data sheet shall define the specification of the product as agreed between Nexperia and its customer, unless Nexperia and customer have explicitly agreed otherwise in writing. In no event however, shall an agreement be valid in which the Nexperia product is deemed to offer functions and qualities beyond those described in the Product data sheet.

9.3 Disclaimers

Limited warranty and liability — Information in this document is believed to be accurate and reliable. However, Nexperia does not give any representations or warranties, expressed or implied, as to the accuracy or completeness of such information and shall have no liability for the consequences of use of such information.

In no event shall Nexperia be liable for any indirect, incidental, punitive, special or consequential damages (including - without limitation - lost profits, lost savings, business interruption, costs related to the removal or replacement of any products or rework charges) whether or not such damages are based on tort (including negligence), warranty, breach of contract or any other legal theory.

Notwithstanding any damages that customer might incur for any reason whatsoever, Nexperia's aggregate and cumulative liability towards customer for the products described herein shall be limited in accordance with the *Terms and conditions of commercial sale* of Nexperia.

Right to make changes — Nexperia reserves the right to make changes to information published in this document, including without limitation specifications and product descriptions, at any time and without notice. This document supersedes and replaces all information supplied prior to the publication hereof.

Suitability for use — Nexperia products are not designed, authorized or warranted to be suitable for use in life support, life-critical or safety-critical systems or equipment, nor in applications where failure or

malfunction of a Nexperia product can reasonably be expected to result in personal injury, death or severe property or environmental damage. Nexperia accepts no liability for inclusion and/or use of Nexperia products in such equipment or applications and therefore such inclusion and/or use is at the customer's own risk.

Applications — Applications that are described herein for any of these products are for illustrative purposes only. Nexperia makes no representation or warranty that such applications will be suitable for the specified use without further testing or modification.

Customers are responsible for the design and operation of their applications and products using Nexperia products, and Nexperia accepts no liability for any assistance with applications or customer product design. It is customer's sole responsibility to determine whether the Nexperia product is suitable and fit for the customer's applications and products planned, as well as for the planned application and use of customer's third party customer(s). Customers should provide appropriate design and operating safeguards to minimize the risks associated with their applications and products.

Nexperia does not accept any liability related to any default, damage, costs or problem which is based on any weakness or default in the customer's applications or products, or the application or use by customer's third party customer(s). Customer is responsible for doing all necessary testing for the customer's applications and products using Nexperia products in order to avoid a default of the applications and the products or of the application or use by customer's third party customer(s). Nexperia does not accept any liability in this respect.

Limiting values — Stress above one or more limiting values (as defined in the Absolute Maximum Ratings System of IEC 60134) will cause permanent damage to the device. Limiting values are stress ratings only and (proper) operation of the device at these or any other conditions above those given in the Recommended operating conditions section (if present) or the Characteristics sections of this document is not warranted. Constant or repeated exposure to limiting values will permanently and irreversibly affect the quality and reliability of the device.

Terms and conditions of commercial sale — Nexperia products are sold subject to the general terms and conditions of commercial sale, as published at <http://www.nexperia.com/profile/terms>, unless otherwise agreed in a valid written individual agreement. In case an individual agreement is concluded only the terms and conditions of the respective agreement shall apply. Nexperia hereby expressly objects to applying the customer's general terms and conditions with regard to the purchase of Nexperia products by customer.

No offer to sell or license — Nothing in this document may be interpreted or construed as an offer to sell products that is open for acceptance or the grant, conveyance or implication of any license under any copyrights, patents or other industrial or intellectual property rights.

Export control — This document as well as the item(s) described herein may be subject to export control regulations. Export might require a prior authorization from national authorities.

Quick reference data — The Quick reference data is an extract of the product data given in the Limiting values and Characteristics sections of this document, and as such is not complete, exhaustive or legally binding.

Non-automotive qualified products — Unless this data sheet expressly states that this specific Nexperia product is automotive qualified, the product is not suitable for automotive use. It is neither qualified nor tested in accordance with automotive testing or application requirements. Nexperia accepts no liability for inclusion and/or use of non-automotive qualified products in automotive equipment or applications.

In the event that customer uses the product for design-in and use in automotive applications to automotive specifications and standards, customer (a) shall use the product without Nexperia's warranty of the

product for such automotive applications, use and specifications, and (b) whenever customer uses the product for automotive applications beyond Nexperia's specifications such use shall be solely at customer's own risk, and (c) customer fully indemnifies Nexperia for any liability, damages or failed product claims resulting from customer design and use of the product for automotive applications beyond Nexperia's standard warranty and Nexperia's product specifications.

9.4 Trademarks

Notice: All referenced brands, product names, service names and trademarks are the property of their respective owners.

10. Contact information

For more information, please visit: <http://www.nexperia.com>

For sales office addresses, please send an email to: salesaddresses@nexperia.com

11. Contents

1	Product profile	1
1.1	General description	1
1.2	Features and benefits	1
1.3	Applications	1
1.4	Quick reference data	2
2	Pinning information	2
3	Ordering information	3
4	Limiting values	4
5	Characteristics	5
6	Application information	7
6.1	Insertion loss	7
6.2	Selection	9
6.2.1	SDHC and MMC memory interface	9
6.2.2	LCD interfaces, medium-speed interfaces	11
6.2.3	Keypad, low-speed interfaces	11
7	Package outline	12
8	Revision history	15
9	Legal information	16
9.1	Data sheet status	16
9.2	Definitions	16
9.3	Disclaimers	16
9.4	Trademarks	17
10	Contact information	17
11	Contents	18