

Analog Devices Welcomes Hittite Microwave Corporation

NO CONTENT ON THE ATTACHED DOCUMENT HAS CHANGED



THIS PAGE INTENTIONALLY LEFT BLANK



HMC659LC5

GaAs PHEMT MMIC POWER AMPLIFIER, DC - 15 GHz

Typical Applications

The HMC659LC5 wideband PA is ideal for:

- Telecom Infrastructure
- Microwave Radio & VSAT
- Military & Space
- Test Instrumentation
- Fiber Optics

Features

- P1dB Output Power: +27.5 dBm
- Gain: 19 dB
- Output IP3: +35 dBm
- Supply Voltage: +8V @ 300 mA
- 50 Ohm Matched Input/Output
- 32 Lead Ceramic 5 x 5 mm SMT Package: 25 mm²

Functional Diagram

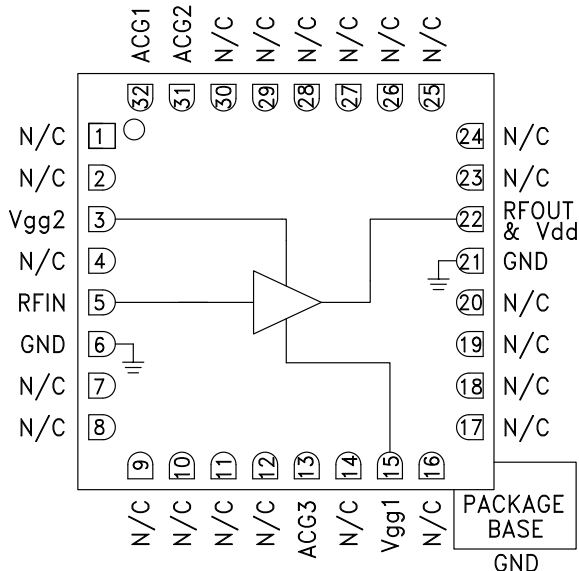

General Description

The HMC659LC5 is a GaAs MMIC pHEMT Distributed Power Amplifier which is housed in a leadless 5 x 5 mm RoHS compliant ceramic SMT package operating between DC and 15 GHz. The amplifier provides 19 dB of gain, +35 dBm output IP3 and +27.5 dBm of output power at 1 dB gain compression, while requiring 300mA from a +8V supply. Gain flatness is excellent at ±1.4 dB from DC - 15 GHz making the HMC659LC5 ideal for EW, ECM, Radar and test equipment applications. The HMC659LC5 amplifier I/Os are internally matched to 50 Ohms with no external components. The HMC659LC5 is compatible with high volume surface mount manufacturing techniques.

Electrical Specifications, $T_A = +25\text{ }^\circ\text{C}$, $V_{dd} = +8\text{V}$, $V_{gg2} = +3\text{V}$, $I_{dd} = 300\text{ mA}^*$

Parameter	Min.	Typ.	Max.	Min.	Typ.	Max.	Min.	Typ.	Max.	Units
Frequency Range	DC - 6			6 - 11			11 - 15			GHz
Gain	16	19		15	18		14	17		dB
Gain Flatness		± 0.7			± 0.4			± 0.7		dB
Gain Variation Over Temperature		0.015			0.019			0.022		dB/ °C
Input Return Loss		20			18			17		dB
Output Return Loss		19			20			15		dB
Output Power for 1 dB Compression (P1dB)	23.5	26.5		24.5	27.5		23.5	26.5		dBm
Saturated Output Power (P _{sat})		28.0			28.5			27.5		dBm
Output Third Order Intercept (IP3)		35			32			29		dBm
Noise Figure		3.0			2.5			3.5		dB
Supply Current (I _{dd}) (V _{dd} = 8V, V _{gg1} = -0.8V Typ.)		300			300			300		mA

*Adjust V_{gg1} between -2 to 0V to achieve I_{dd}= 300 mA typical.



**GaAs PHEMT MMIC
POWER AMPLIFIER, DC - 15 GHz**

Gain & Return Loss

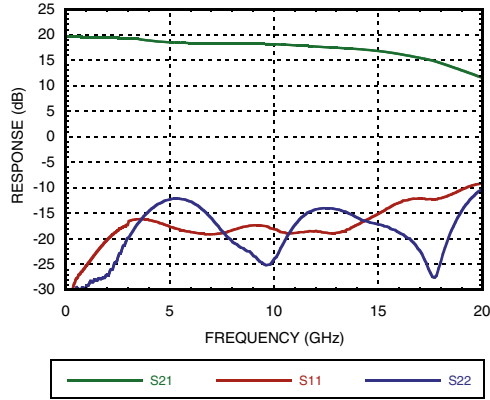

Gain vs. Temperature

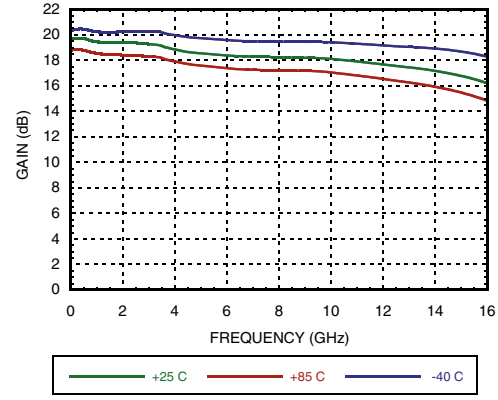

Input Return Loss vs. Temperature

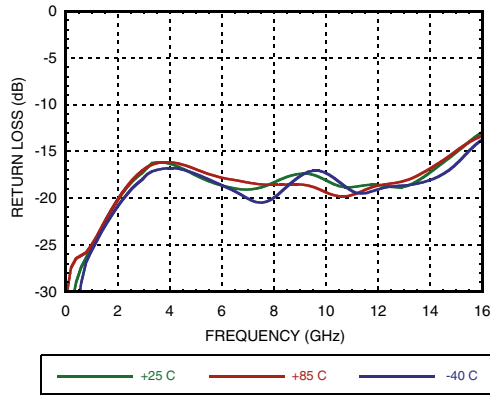

Output Return Loss vs. Temperature

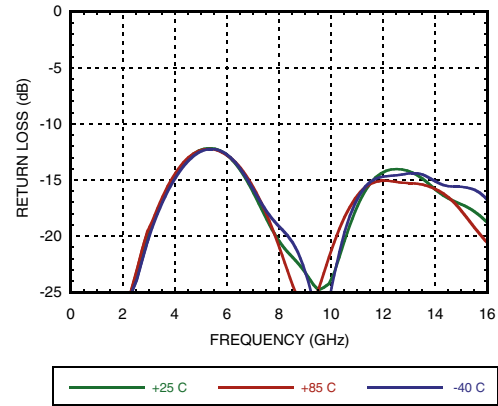

Reverse Isolation vs. Temperature

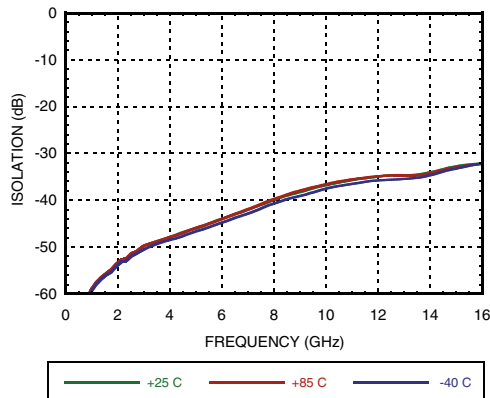

Noise Figure vs. Temperature

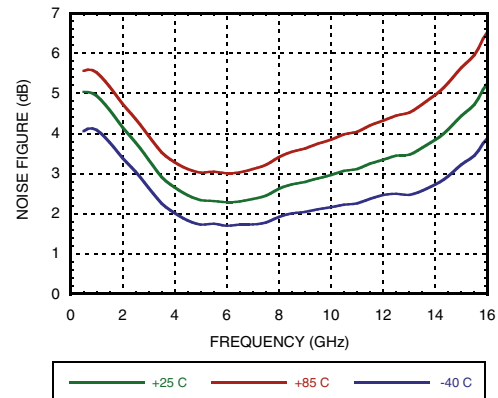



GaAs PHEMT MMIC POWER AMPLIFIER, DC - 15 GHz

LINEAR & POWER AMPLIFIERS - SMT

Output P1dB vs. Temperature

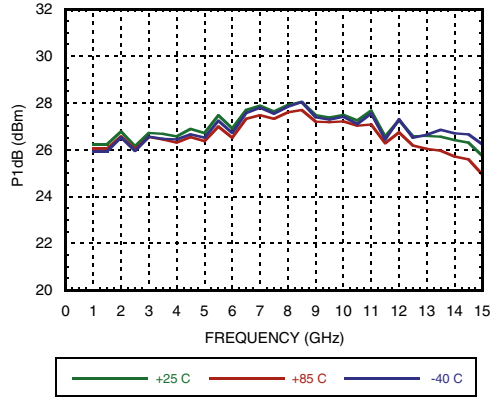

Psat vs. Temperature

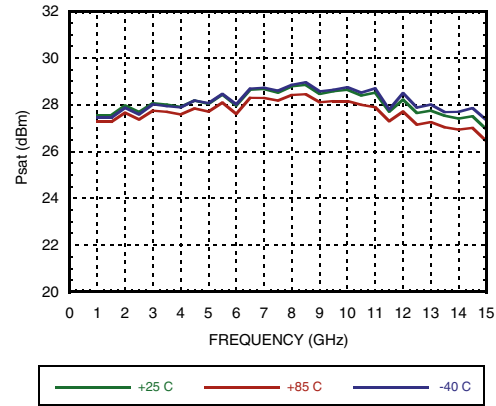

Output IP3 vs. Temperature

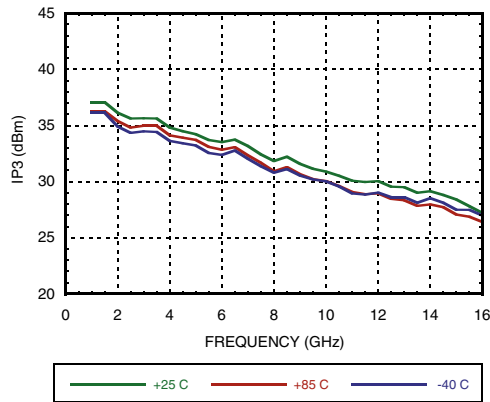

Output IP3 vs. Output Power @ 5GHz

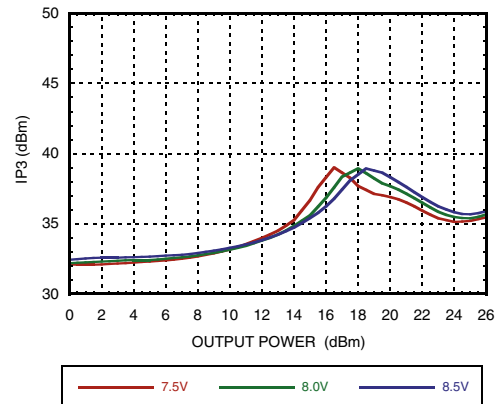

**Gain, Power & Output IP3 vs.
Supply Voltage @ 7 GHz, Fixed Vgg**

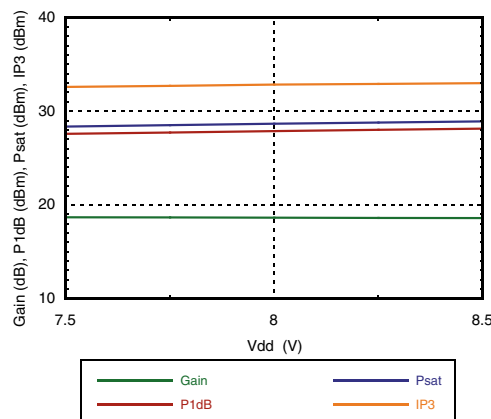



GaAs PHEMT MMIC POWER AMPLIFIER, DC - 15 GHz

Power Compression @ 2 GHz

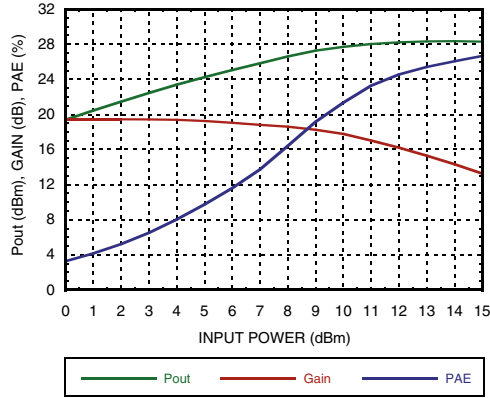

Power Compression @ 7 GHz

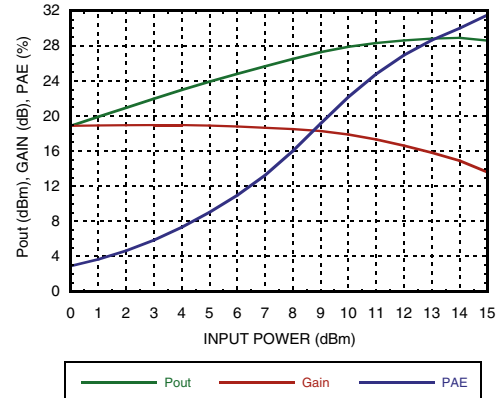

Power Compression @ 15 GHz

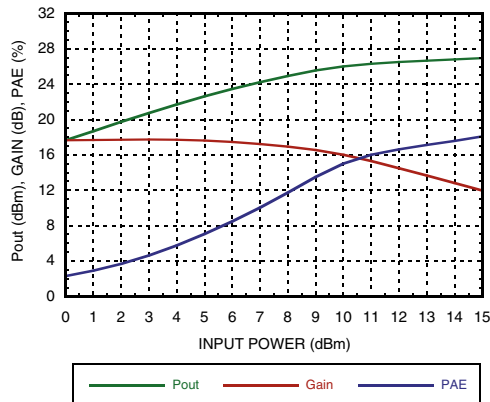

Power Dissipation

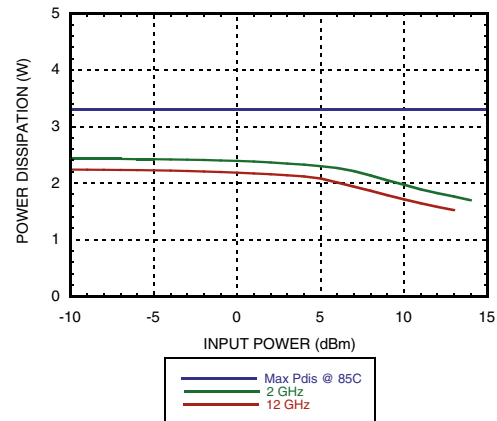

Absolute Maximum Ratings

Drain Bias Voltage (Vdd)	9 Vdc
Gate Bias Voltage (Vgg1)	-2 to 0 Vdc
Gate Bias Voltage (Vgg2)	+2V to +4V
RF Input Power (RFIN)(Vdd = +8 Vdc)	+20 dBm
Channel Temperature	175 °C
Continuous Pdis (T= 85 °C) (derate 37 mW/°C above 85 °C)	3.3 W
Thermal Resistance (channel to ground paddle)	27.3 °C/W
Storage Temperature	-65 to 150 °C
Operating Temperature	-40 to 85 °C
ESD Sensitivity (HBM)	Class 1A

Typical Supply Current vs. Vdd

Vdd (V)	Idd (mA)
7.5	299
8.0	300
8.5	301



ELECTROSTATIC SENSITIVE DEVICE
OBSERVE HANDLING PRECAUTIONS

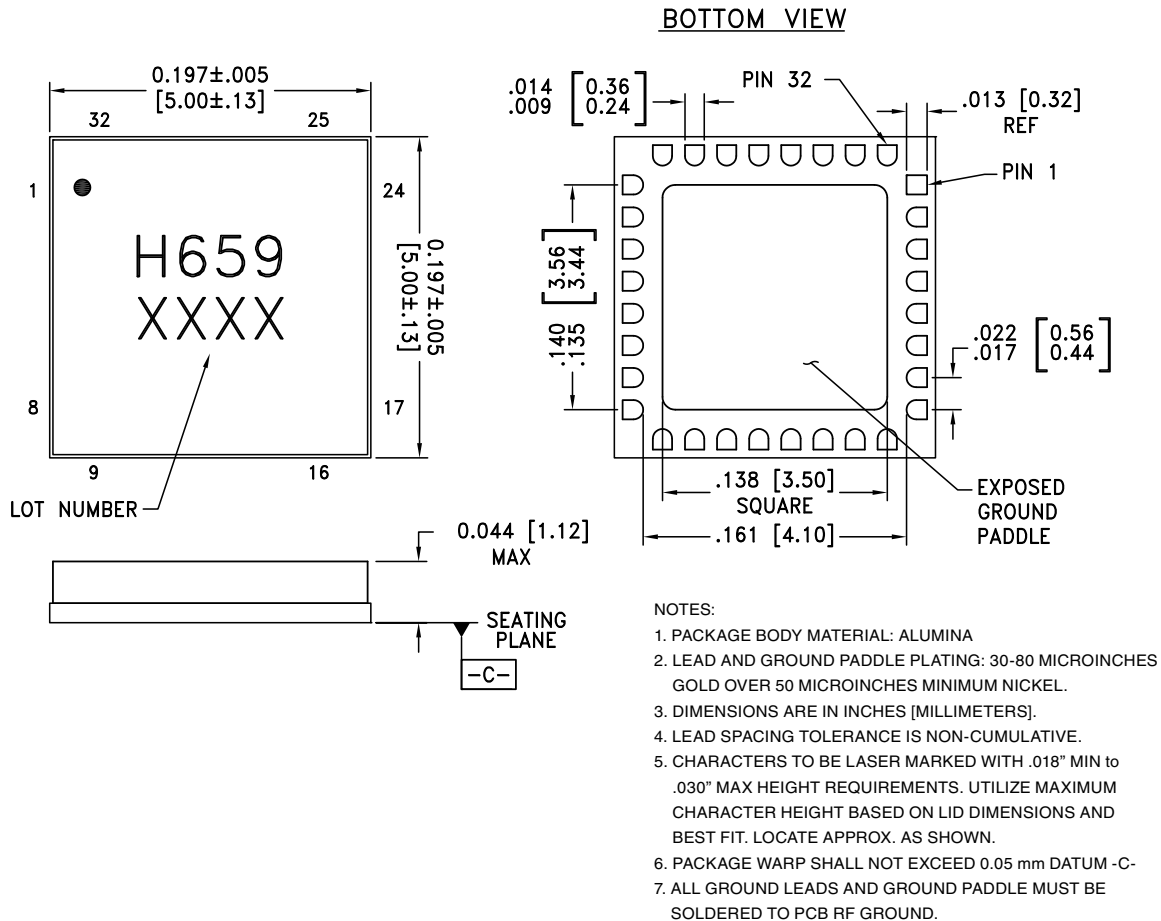

Outline Drawing

Package Information

Part Number	Package Body Material	Lead Finish	MSL Rating	Package Marking ^[2]
HMC659LC5	Alumina, White	Gold over Nickel	MSL3 ^[1]	H659 XXXX

[1] Max peak reflow temperature of 260 °C

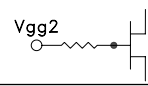
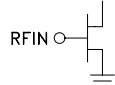
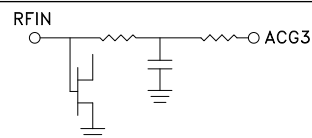
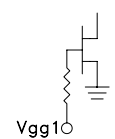
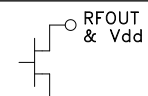
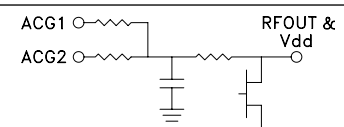
[2] 4-Digit lot number XXXX

Pin Descriptions

Pin Number	Function	Description	Interface Schematic
1, 2, 4, 7 - 12, 14, 16 - 20, 23 - 30	N/C	No connection. These pins may be connected to RF ground. Performance will not be affected.	
3	Vgg2	Gate Control 2 for amplifier. +3V should be applied to Vgg2 for nominal operation.	
5	RFIN	This pad is DC coupled and matched to 50 Ohms.	
13	ACG3	Low frequency termination. Attach bypass capacitor per application circuit herein.	
15	Vgg1	Gate Control 1 for amplifier.	
22	RFOUT & Vdd	RF output for amplifier. Connect the DC bias (Vdd) network to provide drain current (Idd). See application circuit herein.	
31	ACG2	Low frequency termination. Attach bypass capacitor per application circuit herein.	
32	ACG1		
6, 21 Ground Paddle	GND	Ground paddle must be connected to RF/DC ground.	

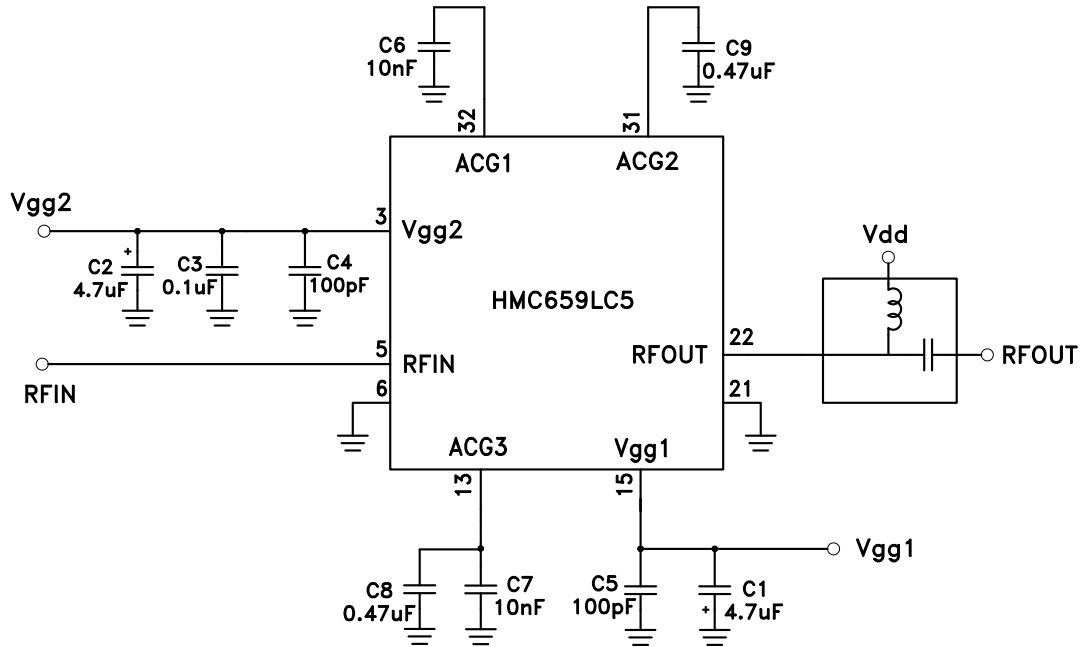
Application Circuit

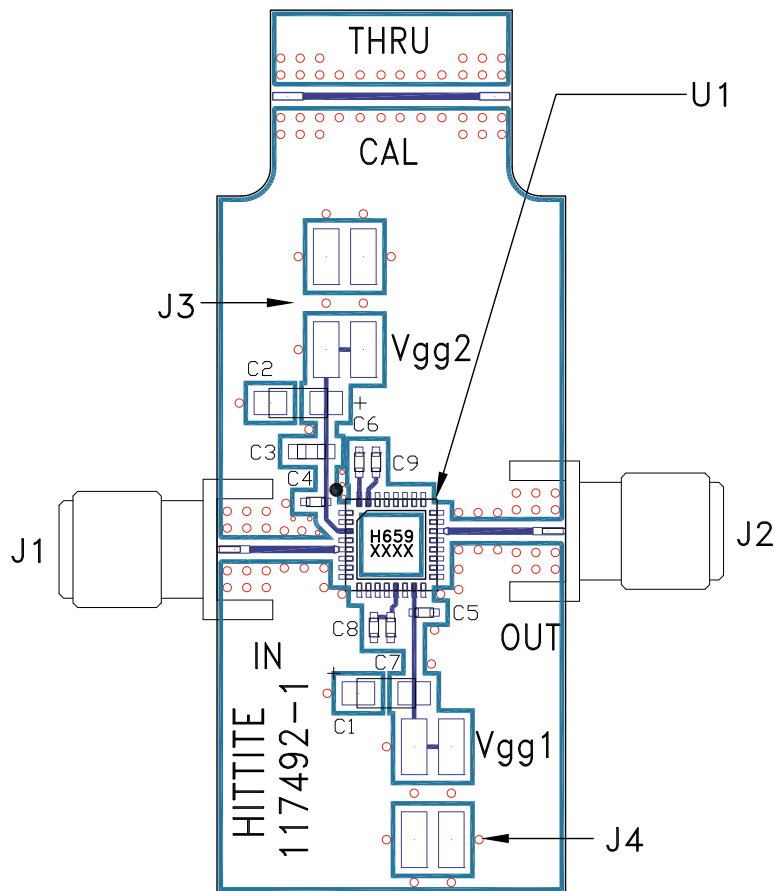
Evaluation PCB

List of Materials for Evaluation PCB 117494 [1]

Item	Description
J1, J2	SMA-SRI-NS
J3, J4	2 mm Molex Header
C1, C2	4.7 μ F Capacitor
C3	0.1 μ F Capacitor, 0603 Pkg.
C4, C5	100 pF Capacitor, 0402 Pkg.
C6, C7	10k pF Capacitor, 0402 Pkg.
C8, C9	0.47 μ F Capacitor, 0402 Pkg
U1	HMC659LC5
PCB [2]	117492 Evaluation PCB

[1] Reference this number when ordering complete evaluation PCB

[2] Circuit Board Material: Rogers 4350

The circuit board used in the final application should use RF circuit design techniques. Signal lines should have 50 Ohm impedance while the package ground leads and package bottom should be connected directly to the ground plane similar to that shown. A sufficient number of via holes should be used to connect the top and bottom ground planes. The evaluation board should be mounted to an appropriate heat sink. The evaluation circuit board shown is available from Hittite upon request.