

Surge Protection Made Simple™ for Twisted Pair Data Cables

UL Listed 497B DIN-Rail Mount Universal Surge Protective Device for Measuring and Control Circuits, and Bus Systems

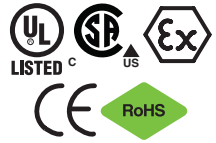

Description

The Cooper Bussmann universal four-pole, DIN-Rail mounted surge arresters provide effective protection with minimum space requirements and are designed for stringent requirements on the availability of measuring and control circuits, and bus systems.

To ensure safe operation, the arresters provide protection against vibration and shock up to a 30-fold acceleration of gravity. The function-optimized design of the devices allows quick and easy removal of protection modules via “make-before-break” terminals that assure continuity of data signals in the protected and unprotected state.

For IEC Applications - Instruction for Surge Protective Device Use In Zone 2 Explosive Atmospheres per ATEX.

- When installed in potentially explosive atmospheres, the Data Signal DIN Series shall be installed into an enclosure which meets the requirements of a recognized type of protection, in accordance with EN 60079-0.
- The Data Signal DIN Series as transient suppressor. This approval applies to the following equipment types:
 - BSPD5DING BSPD12DING BSPD24DING
 - BSPD48DING BSPD5DINLHF BSPD24DINLHF

Ambient and Temperature Class

- 40°C to +80°C, T4:
DEKRA 12ATEX0254 X: II 3 G Ex nA IIC T4 Gc
- Standards used for:
ATEX: EN60079-0: 2009, EN 60079-15: 2005
- UL 497B Listed
- Function-optimized design for safe use and easy installation
- Four-pole and base mounts on grounded 35mm DIN-Rail
- Module removal without signal interruption via “make-before-break” circuitry
- 0-180V BSPD0180DINL automatically adjusts to system operating voltage and can protect data circuits of different voltages up to 100mA load current.

Dimensions-mm

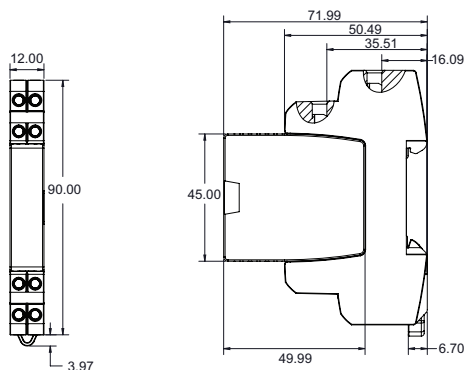

- BSPD5DING
- BSPD12DING
- BSPD24DING
- BSPD48DING
- BSPD5DINLHF
- BSPD24DINLHF
- BSPD0180DINL



Four-Pole DIN-Rail Mount Universal SPD for Data Signal Applications

Circuit Diagrams

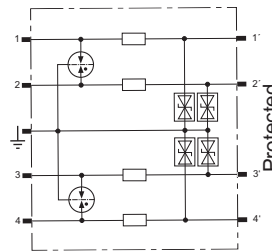

**BSPD5DING
BSPD12DING
BSPD24DING
BSPD48DING**

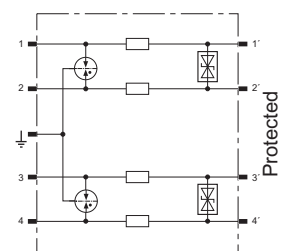

**BSPD5DINLHF
BSPD24DINLHF**

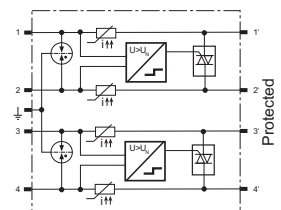
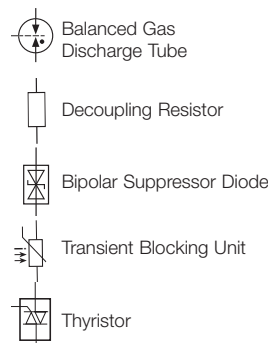

BSPD0180DINL



TECHNICAL DATA							
Catalog number — Prefix: BSPD...	...5DING	...12DING	...24DING	...48DING	...5DINLHF	...24DINLHF	...0180DINL
Nominal voltage (U _N)	5V	12V	24V	48V	5V	24V	0-180V
Nominal current at 45°C (I _N)	1.0A	0.75A	0.75A	0.75A	1.0A	1.0A	≤0.1A@80°C
VPL line-line for I _{imp} D1 (U _p)	≤29V	≤50V	≤102V	≤160V	≤25V	≤65V	≤U _N + 53V
VPL line-PG for I _{imp} D1 (U _p)	≤27V	≤37V	≤66V	≤95V	≤550V	≤550V	-
VPL line-line at 1kV/μs C3 (U _p)	≤18V	≤38V	≤90V	≤140V	≤11V	≤47V	see Note 1
VPL line-PG at 1kV/μs C3 (U _p)	≤9V	≤19V	≤45V	≤70V	≤550V	≤550V	-
VPL line-line for I _n C2 (U _p)	-	-	-	-	-	-	see Note 2
VPL line-PG for C2 / C3 / D1	-	-	-	-	-	-	≤550V
D1 Total lightning impulse current (10/350μs) (I _{imp})	10kA	10kA	10kA	10kA	10kA	10kA	10kA
D1 Lightning impulse current (10/350μs) per line (I _{imp})	2.5kA	2.5kA	2.5kA	2.5kA	2.5kA	2.5kA	2.5kA
C2 Total nominal discharge current (8/20μs) (I _n)	20kA	20kA	20kA	20kA	20kA	20kA	20kA
C2 Nominal discharge current (8/20μs) per line (I _n)	10kA	10kA	10kA	10kA	10kA	10kA	10kA
Series impedance per line	1.0Ω	1.8Ω	1.8Ω	1.8Ω	1.0Ω	1.0Ω	10Ω/7.5Ω typ
Frequency of the operating voltage (f _{U_N})	-	-	-	-	-	-	0-400Hz
Max. continuous operating DC voltage (U _C)	6V	15V	33V	54V	6V	33V	180V
Max. continuous operating AC voltage (U _C)	4.2V	10.6V	23.3V	38.1V	4.2V	23.3V	127V
Permissible superimposed signal voltage (U _{Signal})							± 5V
"Nominal current at 80°C (I _N) (corresponds to max. short-circuit current)"	-	-	-	-	-	-	100mA
Cut-off frequency line-PG (f _C)	1.0MHz	2.7MHz	6.8MHz	8.7MHz	100MHz	100MHz	-
Cut-off frequency line-line (U _{Signal} , balanced 100Ω) (f _C)	-	-	-	-	-	-	50MHz
Capacitance line-line (C)	≤2.7nF	≤1.0nF	≤0.5nF	≤0.35nF	≤25pF	≤25pF	≤80pF
Capacitance line-PG (C)	≤5.4nF	≤2.0nF	≤1.0nF	≤0.7nF	≤16pF	≤16pF	≤16pF
ATEX Approvals	†	†	†	†	†	†	-
Agency information	††	††	††	††	††	††	‡
IEC 61643-21 Test category	D1, C2, C3						
Operating temperature range	-40°C to +80°C						
Degree of protection	IP20						
For mounting on	35mm DIN-Rails per EN 60715						
Grounding	Via base part						
Color / enclosure material	Grey / Polyamide PA 6.6						
Test standards	IEC 61643-21 / EN 61643-21, UL 497B						
Connection (input / output)	Screw terminal						
Conductors	Solid	12-28AWG (4-0.08mm ²)					
	Flexible	14-28AWG (2.5-0.08mm ²)					
Terminal torque	3.5 Lb-In (0.4 N•m)						
Warranty	5 Years*						

* See Cooper Bussmann SPD Limited Warranty Statement (3A1502) for details at www.cooperbussmann.com/surge.

0-180V SPD Application and Mode of Operation

The BSPD0180DINL surge protective device automatically adjusts to the operating voltage (from 0 to 180 volts) of the protected device.

When an overvoltage event occurs, the SPD voltage protection level adjusts itself based upon the output terminal operating voltage of the base.

Note 1 - See Diagram 1 - VPL line-line graph line C3.

Note 2 - See Diagram 1 - VPL line-line graph line C2.

† DEKRA 12ATEX0254 X: II 3 G Ex nA IIC T4 Gc

†† ATEX, UL, CSA

‡ UL 497B

Diagram 1: Voltage Protection Level U_p (V) (Line - Line)

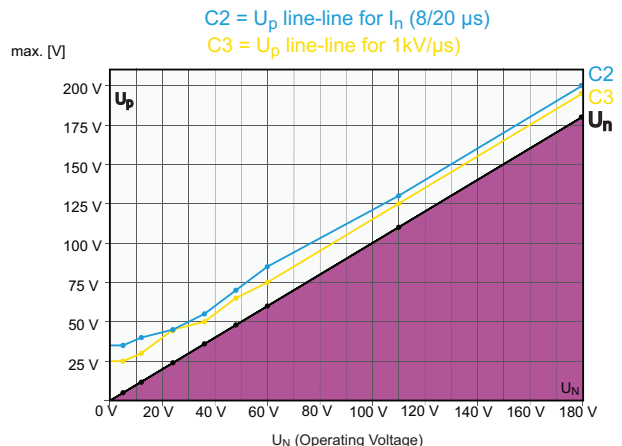

DIN-Rail Universal 4 Wire Data Signal SPDs and Applications

Universal 4 wire data signal SPD products are specified by communication technology. The table below contains the specific SPD product, by part number, and the applications to which they are suited to be used.



Part Numbers	BSPD5DING	BSPD12DING	BSPD24DING	BSPD48DING	BSPD5DINLHF	BSPD24DINLHF	BSPD0180DINL
Bus SYSTEMS AND MEASURING, AND CONTROL TECHNOLOGY							
0-20 mA, 4-20 mA Signals			X			X (4-20mA only)	X
Binary Signals	X	X	X	X			
CAN-Bus (data line only)					X		X
C-Bus (Honeywell)					X		X
Data Highway Plus							X
Device Net (data line only)					X		X
Dupline							X
E-Bus (Honeywell)							X
Fieldbus Foundation						X	X
FIPIO / FIPWAY						X	
FSK					X		X
IEC-Bus (RS485)					X		X
Interbus INLINE (I/O)							X
Interbus INLINE, Long-distance bus					X		X
K Bus						X	
LON - TP/XF 78					X		
LUXMATE Bus						X	X
M Bus							X
MODBUS					X		X
MPI Bus					X		X
Procontic CS31 (RS232)		X					
Procontic T200 (RS422)					X		X
PROFIBUS DP/FMS					X		X
PROFIBUS PA						X	X
PROFIBUS SIMATIC NET					X		X
PSM EG RS422 & RS485					X		X
Rackbus (RS485)					X		X
R Bus					X		X
RS 485					X		X
RS422, V11					X		X
SafetyBUS p					X		X
Securilan LON Bus					X		
SIGMASYS				X			
SS97 SIN/X (RS 232)		X					
SUCONET					X		X
Resistance Temp. Measuring Ni1000, PT100, PT1000 Wire NTC & PTC Thermistors		X					
TTL		X					
TTY 4-20mA			X				
TELECOMMUNICATION, TELEPHONY							
a/b Wires							X
ADSL, ADSL 2+							X
ISDN S ₀ , S _{2m} /U _{2m} , U _{KO} /U _{PO}							X
Modem M1		X					
SDSL, SHDSL						X	X
Telephony Systems (e.g., Siemens, HICOM, Alcatel)							X
T-DSL							X
Telecommunication Systems (e.g., Siemens, HICOM, Alcatel)							X
VDSL							X
DATA NETWORKS							
V 24 (RS232 C)		X					

The only controlled copy of this Data Sheet is the electronic read-only version located on the Cooper Bussmann Network Drive. All other copies of this document are by definition uncontrolled. This bulletin is intended to clearly present comprehensive product data and provide technical information that will help the end user with design applications. Cooper Bussmann reserves the right, without notice, to change design or construction of any products and to discontinue or limit distribution of any products. Cooper Bussmann also reserves the right to change or update, without notice, any technical information contained in this bulletin. Once a product has been selected, it should be tested by the user in all possible applications.