

MAXIM

1.25Ω, Dual SPST, CMOS Analog Switches

MAX4680/MAX4690/MAX4700

General Description

The MAX4680/MAX4690/MAX4700 dual analog switches feature low on-resistance of 1.25Ω max. On-resistance is matched between switches to 0.3Ω max and is flat (0.3Ω max) over the specified signal range. Each switch can handle Rail-to-Rail® analog signals. Off-leakage current is only 5nA max at +85°C. These analog switches are ideal in low-distortion applications and are the preferred solution over mechanical relays in automatic test equipment or applications where current switching is required. They have low power requirements, require less board space, and are more reliable than mechanical relays.

The MAX4680 has two NC (normally closed) switches, and the MAX4690 has two NO (normally open) switches. The MAX4700 has one NC and one NO switch and features guaranteed break-before-make switching.

These devices operate from a +4.5V to +36V single supply or from ±4.5V to ±20V dual supplies. A separate logic supply pin guarantees TTL/CMOS-logic compatibility while operating across the entire supply voltage range.

Applications

Reed Relay Replacement Data Acquisition Systems
 Test Equipment Sample-and-Hold Circuits
 Communication Systems
 PBX, PABX Systems

Features

- ◆ Low On-Resistance (1.25Ω max)
- ◆ Guaranteed R_{ON} Match Between Channels (0.3Ω max)
- ◆ Guaranteed R_{ON} Flatness Over Specified Signal Range (0.3Ω max)
- ◆ Rail-to-Rail Signal Handling
- ◆ Guaranteed Break-Before-Make (MAX4700)
- ◆ +4.5V to +36V Single-Supply Operation
 ±4.5V to ±20V Dual-Supply Operation
- ◆ TTL/CMOS-Compatible Control Inputs
- ◆ >2kV ESD Protection per Method 3015.7

Ordering Information

| PART | TEMP. RANGE | PIN-PACKAGE |
|------------|----------------|----------------|
| MAX4680CAE | 0°C to +70°C | 16 SSOP |
| MAX4680CWE | 0°C to +70°C | 16 Wide SO |
| MAX4680CPE | 0°C to +70°C | 16 Plastic DIP |
| MAX4680EAE | -40°C to +85°C | 16 SSOP |
| MAX4680EWE | -40°C to +85°C | 16 Wide SO |
| MAX4680EPE | -40°C to +85°C | 16 Plastic DIP |

Ordering Information continued at end of data sheet.

Pin Configurations/Functional Diagrams/Truth Tables

TOP VIEW

SSOP/SO/DIP

| MAX4680 | |
|---------|--------|
| LOGIC | SWITCH |
| 0 | ON |
| 1 | OFF |

N.C. = NOT INTERNALLY CONNECTED

SSOP/SO/DIP

| MAX4690 | |
|---------|--------|
| LOGIC | SWITCH |
| 0 | OFF |
| 1 | ON |

SWITCHES SHOWN FOR LOGIC "0" INPUT

SSOP/SO/DIP

| MAX4700 | | |
|---------|----------|----------|
| LOGIC | SWITCH 1 | SWITCH 2 |
| 0 | OFF | ON |
| 1 | ON | OFF |

Rail-to-Rail is a registered trademark of Nippon Motorola, Ltd.



Maxim Integrated Products 1

For free samples & the latest literature: <http://www.maxim-ic.com>, or phone 1-800-998-8800.
 For small orders, phone 1-800-835-8769.

1.25Ω, Dual SPST, CMOS Analog Switches

ABSOLUTE MAXIMUM RATINGS

| | |
|---|----------------------------|
| V+ to GND | -0.3V to +44V |
| V- to GND | +0.3V to -44V |
| V+ to V- | -0.3V to +44V |
| V _L to GND | -0.3V to (V+ + 0.3V) |
| All Other Pins to GND (Note 1) | (V- - 0.3V) to (V+ + 0.3V) |
| Continuous Current (COM ₋ , NO ₋ , NC ₋) | ±200mA |
| Peak Current (COM ₋ , NO ₋ , NC ₋) (pulsed at 1ms, 10% duty cycle) | ±300mA |

| | |
|---|-----------------|
| Continuous Power Dissipation (T _A = +70°C) | |
| SSOP (derate 7.1mW/°C above +70°C) | 571mW |
| Wide SO (derate 9.52mW/°C above +70°C) | 762mW |
| Plastic DIP (derate 10.53mW/°C above +70°C) | 842mW |
| Operating Temperature Ranges | |
| MAX4 ₋ OC_E | 0°C to +70°C |
| MAX4 ₋ OE_E | -40°C to +85°C |
| Storage Temperature Range | -65°C to +150°C |
| Lead Temperature (soldering, 10sec) | +300°C |

Note 1: Signals on NC₋, NO₋, COM₋, or IN₋ exceeding V+ or V- are clamped by internal diodes. Limit forward diode current to maximum current rating.

Stresses beyond those listed under "Absolute Maximum Ratings" may cause permanent damage to the device. These are stress ratings only, and functional operation of the device at these or any other conditions beyond those indicated in the operational sections of the specifications is not implied. Exposure to absolute maximum rating conditions for extended periods may affect device reliability.

ELECTRICAL CHARACTERISTICS—Dual Supplies

(V+ = +15V, V- = -15V, V_L = +5V, V_{IN_H} = +2.4V, V_{IN_L} = +0.8V, T_A = T_{MIN} to T_{MAX}, unless otherwise noted. Typical values are at T_A = +25°C.) (Note 2)

| PARAMETER | SYMBOL | CONDITIONS | MIN | TYP | MAX | UNITS |
|--|--|--|------|-------|------|-------|
| ANALOG SWITCH | | | | | | |
| Input Voltage Range (Note 3) | V _{COM₋} , V _{NO₋} , V _{NC₋} | | V- | | V+ | V |
| COM ₋ to NO ₋ or NC ₋ On-Resistance | R _{ON} | I _{COM₋} = 10mA, V _{NO₋} or V _{NC₋} = ±10V, T _A = +25°C | | 0.9 | 1.25 | Ω |
| | | T _A = T _{MIN} to T _{MAX} | | | 1.5 | |
| COM ₋ to NO ₋ or NC ₋ On-Resistance Match Between Channels (Notes 3, 4) | ΔR _{ON} | I _{COM₋} = 10mA, V _{NO₋} or V _{NC₋} = ±10V, T _A = +25°C | | 0.09 | 0.3 | Ω |
| | | T _A = T _{MIN} to T _{MAX} | | | 0.5 | |
| COM ₋ to NO ₋ or NC ₋ On-Resistance Flatness (Notes 3, 5) | R _{FLAT(ON)} | I _{COM₋} = 10mA; V _{NO₋} or V _{NC₋} = -5V, 0, 5V, T _A = +25°C | | 0.06 | 0.3 | Ω |
| | | T _A = T _{MIN} to T _{MAX} | | | 0.5 | |
| Off-Leakage Current (NO ₋ or NC ₋) (Note 6) | I _{NO₋} , I _{NC₋} | V _{COM₋} = ±10V, V _{NO₋} or V _{NC₋} = ∓10V, T _A = +25°C | -0.5 | 0.01 | 0.5 | nA |
| | | T _A = T _{MIN} to T _{MAX} | -5 | | 5 | |
| COM ₋ Off-Leakage Current (Note 6) | I _{COM₋(OFF)} | V _{COM₋} = ±10V, V _{NO₋} or V _{NC₋} = ∓10V, T _A = +25°C | -0.5 | 0.01 | 0.5 | nA |
| | | T _A = T _{MIN} to T _{MAX} | -2.5 | | 2.5 | |
| COM ₋ On-Leakage Current (Note 6) | I _{COM₋(ON)} | V _{COM₋} = ±10V, V _{NO₋} or V _{NC₋} = ±10V or floating, T _A = +25°C | -1 | 0.01 | 1 | nA |
| | | T _A = T _{MIN} to T _{MAX} | -20 | | 20 | |
| LOGIC INPUT | | | | | | |
| Input Current with Input Voltage High | I _{IN_H} | IN ₋ = 2.4V, all others = 0.8V | -0.5 | 0.001 | 0.5 | μA |
| Input Current with Input Voltage Low | I _{IN_L} | IN ₋ = 0.8V, all others = 2.4V | -0.5 | 0.001 | 0.5 | |

1.25Ω, Dual SPST, CMOS Analog Switches

MAX4680/MAX4690/MAX4700

ELECTRICAL CHARACTERISTICS—Dual Supplies (continued)

(V+ = +15V, V- = -15V, VL = +5V, VIN_H = +2.4V, VIN_L = +0.8V, TA = TMIN to TMAX, unless otherwise noted. Typical values are at TA = +25°C.) (Note 2)

| PARAMETER | SYMBOL | CONDITIONS | | MIN | TYP | MAX | UNITS |
|---------------------------------------|--------|--|-------------------|------|------|-------|-------|
| Logic Input Voltage High | VIN_H | | | 2.4 | | | V |
| Logic Input Voltage Low | VIN_L | | | | | 0.8 | V |
| POWER SUPPLY | | | | | | | |
| Power-Supply Range | | | | ±4.5 | | ±20.0 | V |
| Positive Supply Current | I+ | VIN_ = 0 or 5V | TA = +25°C | -0.5 | 0.01 | 0.5 | μA |
| | | | TA = TMIN to TMAX | -5 | | 5 | |
| Negative Supply Current | I- | VIN_ = 0 or 5V | TA = +25°C | -0.5 | 0.01 | 0.5 | μA |
| | | | TA = TMIN to TMAX | -5 | | 5 | |
| Logic Supply Current | IL | VIN_ = 0 or 5V | TA = +25°C | -0.5 | 0.01 | 0.5 | μA |
| | | | TA = TMIN to TMAX | -5 | | 5 | |
| Ground Current | IGND | VIN_ = 0 or 5V | TA = +25°C | -0.5 | 0.01 | 0.5 | μA |
| | | | TA = TMIN to TMAX | -5 | | 5 | |
| SWITCH DYNAMIC CHARACTERISTICS | | | | | | | |
| Turn-On Time | tON | VCOM_ = ±10V, Figure 2 | TA = +25°C | | 130 | 275 | ns |
| | | | TA = TMIN to TMAX | | | 400 | |
| Turn-Off Time | tOFF | VCOM_ = ±10V, Figure 2 | TA = +25°C | | 90 | 175 | ns |
| | | | TA = TMIN to TMAX | | | 300 | |
| Break-Before-Make Time (MAX4700 only) | tOPEN | VCOM_ = ±10V, Figure 3, TA = +25°C | | 5 | 30 | | ns |
| Charge Injection | Q | CL = 1.0nF, VGEN = 0, RGEN = 0, Figure 4 | | | 550 | | pC |
| Off-Isolation (Note 7) | VISO | RL = 50Ω, CL = 5pF, f = 1MHz, Figure 5 | | | -53 | | dB |
| Crosstalk (Note 8) | VCT | RL = 50Ω, CL = 5pF, f = 1MHz, Figure 6 | | | -65 | | dB |
| NC_ or NO_ Capacitance | COFF | f = 1MHz, Figure 7 | | | 115 | | pF |
| COM Off-Capacitance | CCOM | f = 1MHz, Figure 7 | | | 115 | | pF |
| On-Capacitance | CCOM | f = 1MHz, Figure 8 | | | 520 | | pF |

1.25Ω, Dual SPST, CMOS Analog Switches

ELECTRICAL CHARACTERISTICS—Single Supply

(V+ = +12V, V- = 0, VL = +5V, VINH = 2.4V, VINL = 0.8V, TA = TMIN to TMAX, unless otherwise noted. Typical values are at TA = +25°C.) (Note 2)

| PARAMETER | SYMBOL | CONDITIONS | MIN | TYP | MAX | UNITS | |
|--|-------------------|--|-------------------|-------|-------|-------|----|
| ANALOG SWITCH | | | | | | | |
| Input Voltage Range (Note 3) | VCOM_, VNO_, VNC_ | | GND | | V+ | V | |
| COM_ to NO_ or NC_ On-Resistance | RON | ICOM_ = 10mA, VNO_ or VNC_ = 10V | TA = +25°C | 1.6 | 3 | Ω | |
| | | | TA = TMIN to TMAX | | 3.5 | | |
| COM_ to NO_ or NC_ On-Resistance Match Between Channels (Notes 3, 4) | ΔRON | ICOM_ = 10mA, VNO_ or VNC_ = 10V | TA = +25°C | 0.1 | 0.4 | Ω | |
| | | | TA = TMIN to TMAX | | 0.5 | | |
| COM_ to NO_ or NC_ On-Resistance Flatness (Notes 3, 5) | RFLAT(ON) | ICOM_ = 10mA; VNO_ or VNC_ = 3V, 6V, 9V | TA = +25°C | 0.2 | 0.4 | Ω | |
| | | | TA = TMIN to TMAX | | 0.5 | | |
| Off-Leakage Current (NO_ or NC_) (Notes 6, 9) | INO_, INC_ | VCOM_ = 1V, 10V; VNO_ or VNC_ = 10V, 1V | TA = +25°C | -0.5 | 0.01 | 0.5 | nA |
| | | | TA = TMIN to TMAX | -5 | | 5 | |
| COM_ Off-Leakage Current (Notes 6, 9) | ICOM_(OFF) | VNO_ or VNC_ = 10V, 1V; VCOM_ = 1V, 10V | TA = +25°C | -0.5 | 0.01 | 0.5 | nA |
| | | | TA = TMIN to TMAX | -5 | | 5 | |
| COM_ On-Leakage Current (Notes 6, 9) | ICOM_(ON) | VCOM_ = 1V, 10V; VNO_ or VNC_ = 1V, 10V, or floating | TA = +25°C | -1 | 0.02 | 1 | nA |
| | | | TA = TMIN to TMAX | -20 | | 20 | |
| LOGIC INPUT | | | | | | | |
| Input Current with Input Voltage High | IIN_H | IN_ = 2.4V, all others = 0.8V | -0.5 | 0.001 | 0.5 | μA | |
| Input Current with Input Voltage Low | IIN_L | IN_ = 0.8V, all others = 2.4V | -0.5 | 0.001 | 0.5 | μA | |
| Logic Input Voltage High | VIN_H | | 2.4 | | | V | |
| Logic Input Voltage Low | VIN_L | | | | 0.8 | V | |
| POWER SUPPLY | | | | | | | |
| Power-Supply Range | | | +4.5 | | +36.0 | V | |
| Positive Supply Current | I+ | VIN_ = 0 or 5V | TA = +25°C | -0.5 | 0.001 | 0.5 | μA |
| | | | TA = TMIN to TMAX | 5 | | 5 | |
| Logic Supply Current | IL | VIN_ = 0 or 5V | TA = +25°C | -0.5 | 0.001 | 0.5 | μA |
| | | | TA = TMIN to TMAX | 5 | | 5 | |
| Ground Current | IGND | VIN_ = 0 or 5V | TA = +25°C | -0.5 | 0.001 | 0.5 | μA |
| | | | TA = TMIN to TMAX | 5 | | 5 | |

1.25Ω, Dual SPST, CMOS Analog Switches

MAX4680/MAX4690/MAX4700

ELECTRICAL CHARACTERISTICS—Single Supply (continued)

($V_+ = +12V$, $V_- = 0$, $V_L = +5V$, $V_{IN_H} = 2.4V$, $V_{IN_L} = 0.8V$, $T_A = T_{MIN}$ to T_{MAX} , unless otherwise noted. Typical values are at $T_A = +25^\circ C$.) (Note 2)

| PARAMETER | SYMBOL | CONDITIONS | MIN | TYP | MAX | UNITS |
|---------------------------------------|------------|---|------------------------------|-----|-----|-------|
| SWITCH DYNAMIC CHARACTERISTICS | | | | | | |
| Turn-On Time (Note 3) | t_{ON} | $V_{COM_} = 10V$, Figure 2 | $T_A = +25^\circ C$ | 225 | 400 | ns |
| | | | $T_A = T_{MIN}$ to T_{MAX} | | 500 | |
| Turn-Off Time (Note 3) | t_{OFF} | $V_{COM_} = 10V$, Figure 2 | $T_A = +25^\circ C$ | 100 | 250 | ns |
| | | | $T_A = T_{MIN}$ to T_{MAX} | | 350 | |
| Break-Before-Make Time (Note 3) | t_{OPEN} | $V_{COM_} = 10V$, Figure 3, $T_A = +25^\circ C$ | 5 | 125 | | ns |
| Charge Injection | Q | $C_L = 1.0nF$, $V_{GEN} = 0$, $R_{GEN} = 0$, Figure 4 | | -60 | | pC |
| Crosstalk (Note 8) | V_{CT} | $R_L = 50\Omega$, $C_L = 5pF$, $f = 1MHz$, Figure 6 | | -65 | | dB |
| NC_ or NO_ Capacitance | C_{OFF} | $f = 1MHz$, Figure 7 | | 175 | | pF |
| COM Off-Capacitance | C_{COM} | $f = 1MHz$, Figure 7 | | 175 | | pF |
| On-Capacitance | C_{COM} | $f = 1MHz$, Figure 8 | | 275 | | pF |

Note 2: The algebraic convention, where the most negative value is a minimum and the most positive value a maximum, is used in this data sheet.

Note 3: Guaranteed by design.

Note 4: $\Delta R_{ON} = R_{ON(MAX)} - R_{ON(MIN)}$.

Note 5: Flatness is defined as the difference between the maximum and minimum value of on-resistance as measured over the specified analog signal range.

Note 6: Leakage parameters are 100% tested at maximum-rated hot temperature and guaranteed by correlation at $+25^\circ C$.

Note 7: Off-isolation = $20\log_{10} [V_{COM} / (V_{NC} \text{ or } V_{NO})]$, V_{COM} = output, V_{NC} or V_{NO} = input to off switch.

Note 8: Between any two switches.

Note 9: Leakage testing at single supply is guaranteed by testing with dual supplies.

Typical Operating Characteristics

($T_A = +25^\circ C$, unless otherwise noted.)

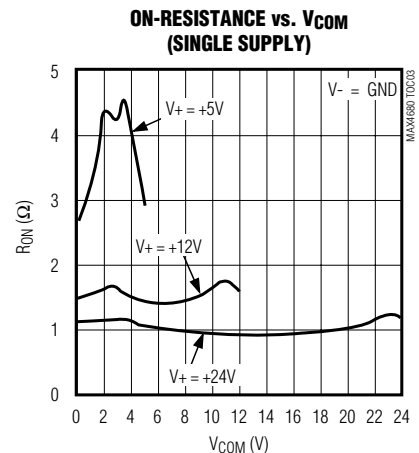
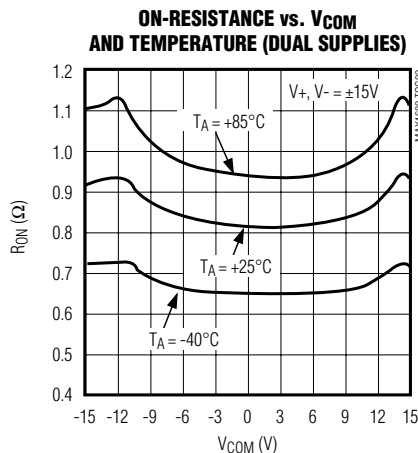
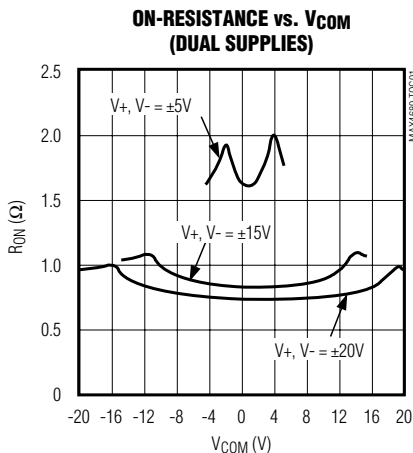

1.25Ω, Dual SPST, CMOS Analog Switches

Typical Operating Characteristics (continued)

(T_A = +25°C, unless otherwise noted.)

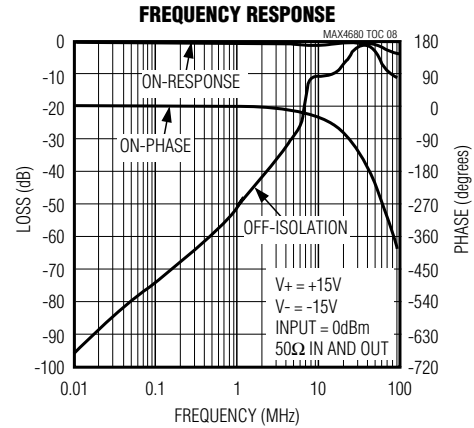
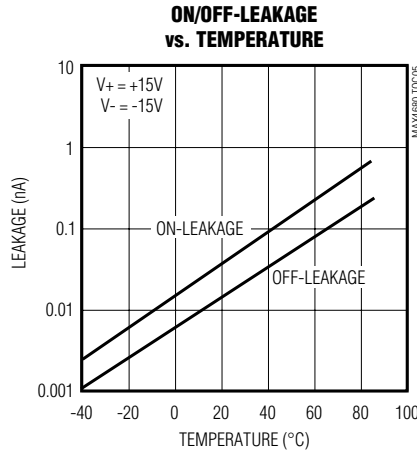
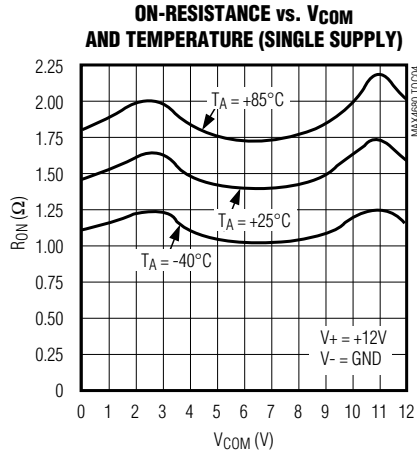

1.25Ω, Dual SPST, CMOS Analog Switches

Pin Description

MAX4680/MAX4690/MAX4700

| PIN | | | NAME | FUNCTION |
|--------------------|--------------------|--------------------|----------------|---|
| MAX4680 | MAX4690 | MAX4700 | | |
| 1, 3, 6, 8, 10, 15 | 1, 3, 6, 8, 10, 15 | 1, 3, 6, 8, 10, 15 | N.C. | No connection. Not internally connected. Connect to GND or low-impedance point to improve on/off-isolation. |
| 2, 7 | 2, 7 | 2, 7 | IN1, IN2 | Logic-Control Digital Inputs |
| 4 | 4 | 4 | V- | Negative Analog Supply Voltage Input. Connect to GND for single-supply operation. |
| 5 | 5 | 5 | GND | Ground |
| 9, 16 | – | – | NC2, NC1 | Analog Switch Normally Closed Terminals |
| 11, 14 | 11, 14 | 11, 14 | COM2, COM1 | Analog Switch Common Terminals |
| 12 | 12 | 12 | V _L | Logic Supply Input |
| 13 | 13 | 13 | V+ | Positive Analog Supply Input |
| – | 9, 16 | – | NO2, NO1 | Analog Switch Normally Open Terminals |
| – | – | 9 | NC1 | Analog Switch Normally Closed Terminal |
| – | – | 16 | NO1 | Analog Switch Normally Open Terminal |

1.25Ω, Dual SPST, CMOS Analog Switches

Applications Information

Overvoltage Protection

Proper power-supply sequencing is recommended for all CMOS devices. Do not exceed the absolute maximum ratings because stresses beyond the listed ratings can cause permanent damage to the devices. Always sequence V+ on first, then V-, followed by the logic inputs, NO, or COM. If power-supply sequencing is not possible, add two small signal diodes (D1, D2) in series with the supply pins and a Schottky diode between V+ and V_L for overvoltage protection (Figure 1). Adding diodes reduces the analog signal range to one diode drop below V+ and one diode drop above V-, but does not affect the devices' low switch resistance and low-leakage characteristics. Device operation is unchanged, and the difference between V+ and V- should not exceed 44V.



Figure 1. Overvoltage Protection Using External Blocking Diodes



Figure 2. Switching-Time Test Circuit

1.25Ω, Dual SPST, CMOS Analog Switches

MAX4680/MAX4690/MAX4700



Figure 3. Break-Before-Make Interval (MAX4700 only)



Figure 4. Charge-Injection Test Circuit

1.25Ω, Dual SPST, CMOS Analog Switches



Figure 5. Off-Isolation Test Circuit



Figure 6. Crosstalk Test Circuit

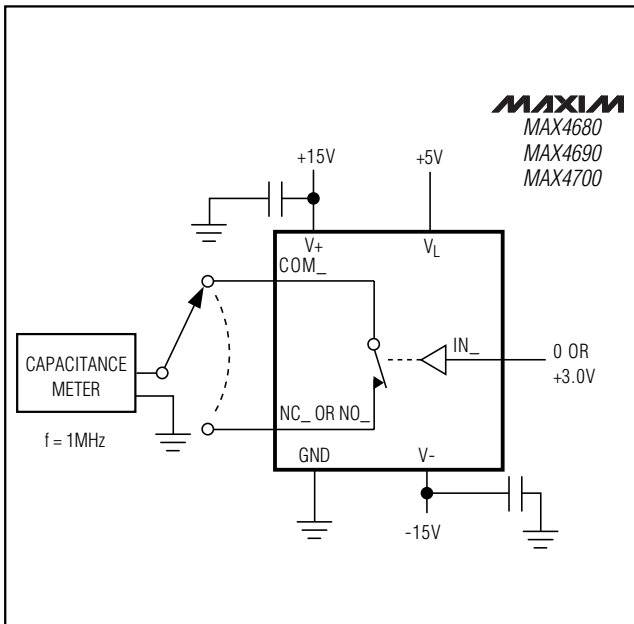

Figure 7. Switch Off-Capacitance Test Circuit

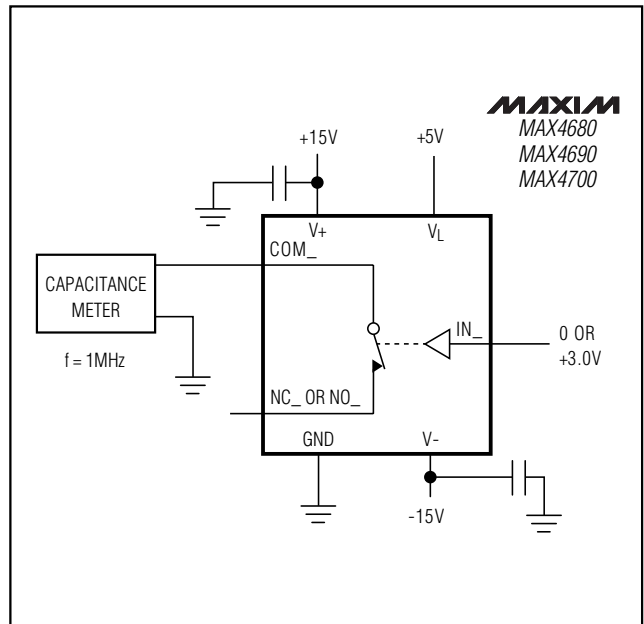

Figure 8. Switch On-Capacitance Test Circuit

1.25Ω, Dual SPST, CMOS Analog Switches

Ordering Information (continued)

| PART | TEMP. RANGE | PIN-PACKAGE |
|------------|----------------|----------------|
| MAX4690CAE | 0°C to +70°C | 16 SSOP |
| MAX4690CWE | 0°C to +70°C | 16 Wide SO |
| MAX4690CPE | 0°C to +70°C | 16 Plastic DIP |
| MAX4690EAE | -40°C to +85°C | 16 SSOP |
| MAX4690EWE | -40°C to +85°C | 16 Wide SO |
| MAX4690EPE | -40°C to +85°C | 16 Plastic DIP |
| MAX4700CAE | 0°C to +70°C | 16 SSOP |
| MAX4700CWE | 0°C to +70°C | 16 Wide SO |
| MAX4700CPE | 0°C to +70°C | 16 Plastic DIP |
| MAX4700EAE | -40°C to +85°C | 16 SSOP |
| MAX4700EWE | -40°C to +85°C | 16 Wide SO |
| MAX4700EPE | -40°C to +85°C | 16 Plastic DIP |

Chip Information

TRANSISTOR COUNT: 108

MAX4680/MAX4690/MAX4700

Package Information

| DIM | INCHES | | MILLIMETERS | |
|-----|----------------|-------|-------------|------|
| | MIN | MAX | MIN | MAX |
| A | 0.068 | 0.078 | 1.73 | 1.99 |
| A1 | 0.002 | 0.008 | 0.05 | 0.21 |
| B | 0.010 | 0.015 | 0.25 | 0.38 |
| C | 0.004 | 0.008 | 0.09 | 0.20 |
| D | SEE VARIATIONS | | | |
| E | 0.205 | 0.209 | 5.20 | 5.38 |
| e | 0.0256 | BSC | 0.65 | BSC |
| H | 0.301 | 0.311 | 7.65 | 7.90 |
| L | 0.025 | 0.037 | 0.63 | 0.95 |
| α | 0° | 8° | 0° | 8° |

| D | INCHES | | MILLIMETERS | | |
|---|--------|-------|-------------|-------|-----|
| | MIN | MAX | MIN | MAX | |
| D | 0.239 | 0.249 | 6.07 | 6.33 | 14L |
| D | 0.239 | 0.249 | 6.07 | 6.33 | 16L |
| D | 0.278 | 0.289 | 7.07 | 7.33 | 20L |
| D | 0.317 | 0.328 | 8.07 | 8.33 | 24L |
| D | 0.397 | 0.407 | 10.07 | 10.33 | 28L |

NOTES:

- D&E DO NOT INCLUDE MOLD FLASH.
- MOLD FLASH OR PROTRUSIONS NOT TO EXCEED .15mm (.006")
- CONTROLLING DIMENSION: MILLIMETER

PROPRIETARY INFORMATION

TITLE: PACKAGE OUTLINE, SSOP, 5.3X.65mm

| | | |
|----------|----------------------|-------|
| APPROVAL | DOCUMENT CONTROL NO. | REV |
| | 21-0056 | A 1/1 |

SSOP EFS

1.25Ω, Dual SPST, CMOS Analog Switches

Package Information (continued)

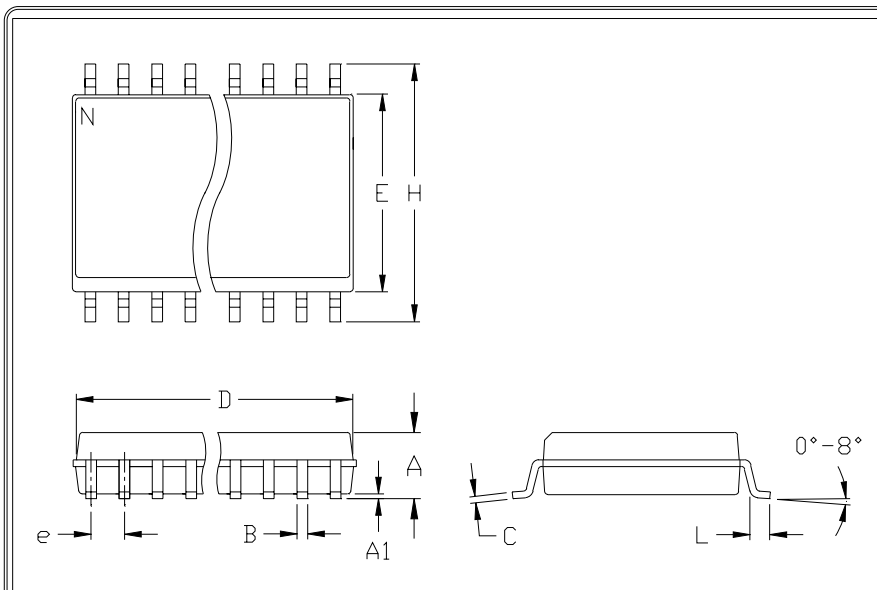

| | INCHES | | MILLIMETERS | |
|----|--------|-------|-------------|-------|
| | MIN | MAX | MIN | MAX |
| A | 0.093 | 0.104 | 2.35 | 2.65 |
| A1 | 0.004 | 0.012 | 0.10 | 0.30 |
| B | 0.014 | 0.019 | 0.35 | 0.49 |
| C | 0.009 | 0.013 | 0.23 | 0.32 |
| e | 0.050 | | 1.27 | |
| E | 0.291 | 0.299 | 7.40 | 7.60 |
| H | 0.394 | 0.419 | 10.00 | 10.65 |
| h | 0.010 | 0.030 | 0.25 | 0.75 |
| L | 0.016 | 0.050 | 0.40 | 1.27 |

| | INCHES | | MILLIMETERS | | N | MS013 |
|---|--------|-------|-------------|-------|----|-------|
| | MIN | MAX | MIN | MAX | | |
| D | 0.398 | 0.413 | 10.10 | 10.50 | 16 | AA |
| D | 0.447 | 0.463 | 11.35 | 11.75 | 18 | AB |
| D | 0.496 | 0.512 | 12.60 | 13.00 | 20 | AC |
| D | 0.598 | 0.614 | 15.20 | 15.60 | 24 | AD |
| D | 0.697 | 0.713 | 17.70 | 18.10 | 28 | AE |

- NOTES:
1. D&E DO NOT INCLUDE MOLD FLASH
 2. MOLD FLASH OR PROTRUSIONS NOT TO EXCEED .15mm (.006")
 3. LEADS TO BE COPLANAR WITHIN .102mm (.004")
 4. CONTROLLING DIMENSION: MILLIMETER
 5. MEETS JEDEC MS013-XX AS SHOWN IN ABOVE TABLE
 6. N = NUMBER OF PINS

| | | | | |
|---|------------------------------------|--|---------|--|
| <small>120 SAN GABRIEL DR. SUNNYVALE, CA 94086 FAX (408) 737-7704</small> <small>PROPRIETARY INFORMATION</small> | PACKAGE FAMILY OUTLINE: SOIC .300" | | 21-0042 | |
| | | | | |

Maxim cannot assume responsibility for use of any circuitry other than circuitry entirely embodied in a Maxim product. No circuit patent licenses are implied. Maxim reserves the right to change the circuitry and specifications without notice at any time.

12 **Maxim Integrated Products, 120 San Gabriel Drive, Sunnyvale, CA 94086 408-737-7600**