

## STRADA-T-DN

Beam for area lighting with shorter illumination distances optimized for CREE XP-G and XP-E. Assembly with installation tape.

### TECHNICAL SPECIFICATIONS:

Dimensions	19.6 x 15.5 mm
Height	8.8 mm
Fastening	tape, pin, screw
ROHS compliant	yes ⓘ

### MATERIAL SPECIFICATIONS:

Component	Type	Material	Colour	Finish
STRADA-T-DN	Single lens	PMMA	clear	
VOSU-WU-M-365-TAPE	Tape			

### ORDERING INFORMATION:

Component		Qty in box	MOQ	MPQ	Box weight (kg)
CA11416_STRADA-T-DN	Single lens	3360	240	240	5.6
» Box size: 451 x 273 x 197 mm					



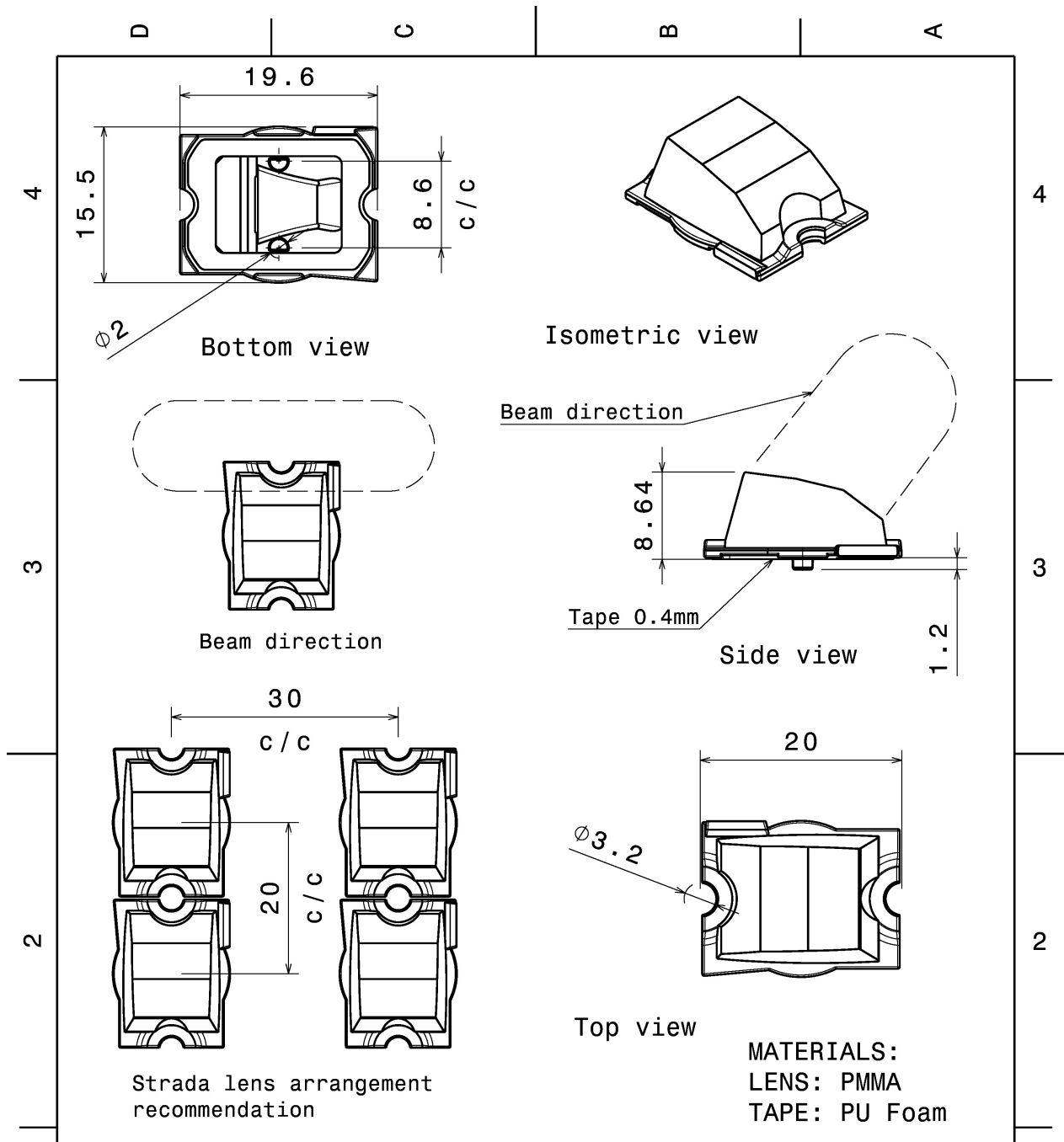

Tolerances if not otherwise shown  
According to DIN ISO 2768-1  
Linear measures: class C  
According to DIN ISO 2768-2  
Form and position: class L

**LEDiL** Ledil Oy  
Salorankatu 10  
FIN 24240 SALO  
Finland

THIRD ANGLE PROJECTION:

**DRAWING TITLE**  
CA11416\_STRADA-T-DN

This drawing is the property of LEDiL Oy. It may not be reproduced, copied or communicated without a written agreement with LEDiL Oy."

SIZE	PART NUMBER
A4	CA11416

SCALE	2:1	WEIGHT	1,31 g	SHEET	1/1
-------	-----	--------	--------	-------	-----

### PHOTOMETRIC DATA (MEASURED):



LED XB-D  
FWHM Asymmetric  
Efficiency 91 %  
LEDs/each optic 1  
Light colour White  
Required components:

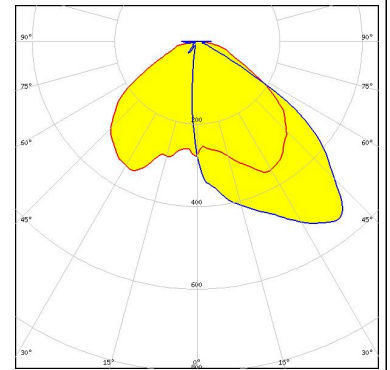

LED XP-E  
FWHM Asymmetric  
Efficiency 92 %  
LEDs/each optic 1  
Light colour White  
Required components:



LED XP-G  
FWHM Asymmetric  
Efficiency 92 %  
LEDs/each optic 1  
Light colour White  
Required components:



LED H35B0 (LEMWA32)  
FWHM Asymmetric  
Efficiency 91 %  
Peak intensity 0.5 cd/lm  
LEDs/each optic 1  
Light colour White  
Required components:

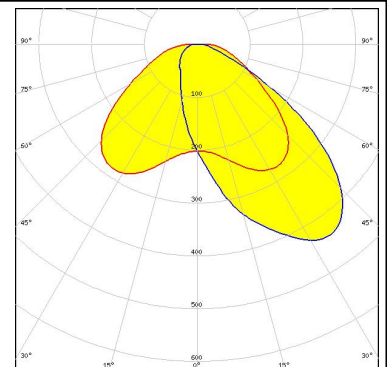

### PHOTOMETRIC DATA (MEASURED):

#### LG Innotek

LED H35C0 (LEMWA33)  
FWHM Asymmetric  
Efficiency 89 %  
Peak intensity 0.5 cd/lm  
LEDs/each optic 1  
Light colour White  
Required components:

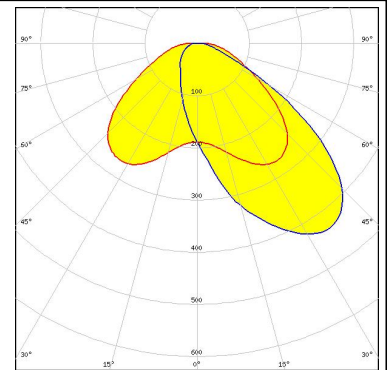

#### LUMILEDS

LED LUXEON A  
FWHM Asymmetric  
Efficiency 92 %  
LEDs/each optic 1  
Light colour White  
Required components:

#### LUMILEDS

LED LUXEON Rebel  
FWHM Asymmetric  
Efficiency 92 %  
LEDs/each optic 1  
Light colour White  
Required components:

#### LUMILEDS

LED LUXEON Rebel ES  
FWHM Asymmetric  
Efficiency 92 %  
LEDs/each optic 1  
Light colour White  
Required components:

### PHOTOMETRIC DATA (MEASURED):

#### LUMILEDS

LED LUXEON TX  
FWHM Asymmetric  
Efficiency 91 %  
Peak intensity 0.5 cd/lm  
LEDs/each optic 1  
Light colour White  
Required components:

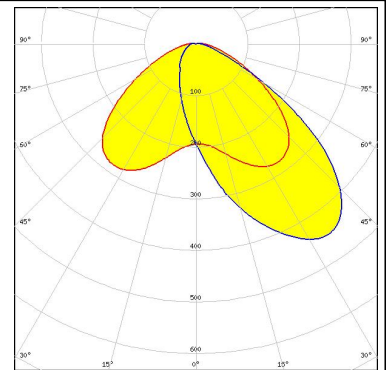

#### LUMILEDS

LED LUXEON Z ES  
FWHM Asymmetric  
Efficiency 90 %  
Peak intensity 0.5 cd/lm  
LEDs/each optic 1  
Light colour White  
Required components:

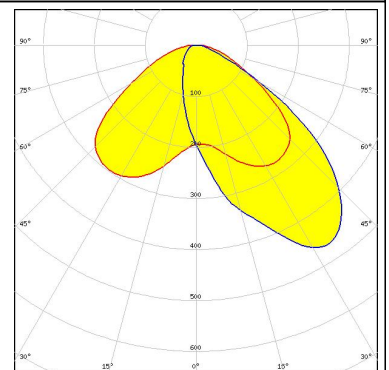

#### NICHIA

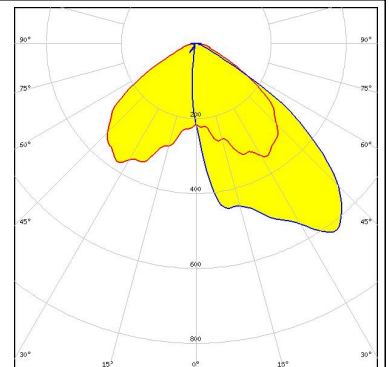

LED NCSxx19A  
FWHM Asymmetric  
Efficiency 92 %  
LEDs/each optic 1  
Light colour White  
Required components:



#### NICHIA

LED NVSxx19A  
FWHM Asymmetric  
Efficiency 92 %  
LEDs/each optic 1  
Light colour White  
Required components:

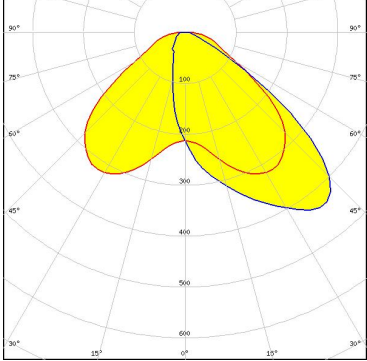
#### PHOTOMETRIC DATA (MEASURED):

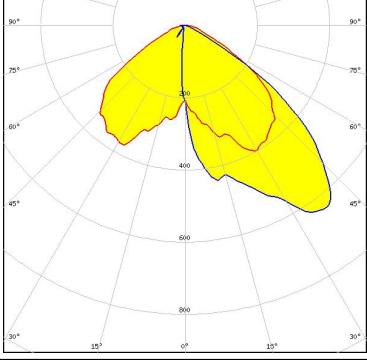
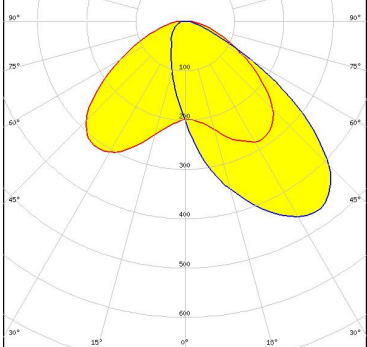
<p><b>OSRAM</b> Opto Semiconductors</p> <p>LED OSLON Square PC            FWHM Asymmetric            Efficiency 93 %            LEDs/each optic 1            Light colour White            Required components:</p>	
<p><b>OSRAM</b> Opto Semiconductors</p> <p>LED OSLON SSL 150            FWHM Asymmetric            Efficiency 92 %            LEDs/each optic 1            Light colour White            Required components:</p>	
<p><b>SEOL</b> SEOUL SEMICONDUCTOR</p> <p>LED Z5            FWHM Asymmetric            Efficiency 92 %            LEDs/each optic 1            Light colour White            Required components:</p>	
<p><b>SEOL</b> SEOUL SEMICONDUCTOR</p> <p>LED Z5M1/Z5M2            FWHM Asymmetric            Efficiency 92 %            Peak intensity 0.5 cd/Im            LEDs/each optic 1            Light colour White            Required components:</p>	

## PHOTOMETRIC DATA (MEASURED):

### SHARP

LED	Double Dome (GM2BB)
FWHM	Asymmetric
Efficiency	92 %
LEDs/each optic	1
Light colour	White
Required components:	

### PHOTOMETRIC DATA (SIMULATED):

<p><b>LUMILEDS</b></p> <p>LED: LUXEON T            FWHM: Asymmetric            Efficiency: 91 %            LEDs/each optic: 1            Light colour: White            Required components:</p>	
<p><b>NICHIA</b></p> <p>LED: NVSxx19B/NVSxx19C            FWHM: Asymmetric            Efficiency: 90 %            LEDs/each optic: 1            Light colour: White            Required components:</p>	
<p><b>OSRAM</b>  <small>Opto Semiconductors</small></p> <p>LED: OSOLON SSL 80            FWHM: Asymmetric            Efficiency: 93 %            Peak intensity: 0.7 cd/lm            LEDs/each optic: 1            Light colour: White            Required components:</p>	



### GENERAL INFORMATION:

NOTE: The typical beam angle will be changed by different color, chip size and chip position tolerance. The typical total beam angle is the full angle measured where the luminous intensity is half of the peak value.

### MATERIALS:

As part of our continuous research and improvement processes, and to ensure the best possible quality and availability of our products, LEDiL reserves the right to change material grades without notice.

### PRODUCT DATA USER AGREEMENT AND DISCLAIMER:

The measured data in the provided downloadable LEDiL Product Datasheets and Mechanical 2D-Drawings is rounded and provided as reference for planning. LEDiL Oy's optical specifications have been verified by conducting performance testing of the products in accordance with the company's quality system. The reported data are averaged results of multiple measurements with typical variation. LEDiL Oy reserves the right to without prior notification make changes and improvements to its products.

LEDiL Oy assumes neither warranty, nor guarantee nor any other liability of any kind for the contents and correctness of the provided data. The provided data has been generated with highest diligence but the provided data may in reality not represent the complete possible variation range of all intrinsic parameters. Therefore, in certain cases a deviation from the provided data could occur.

LEDiL Oy reserves the right to undertake technical changes of its products without further notification which could lead to changes in the provided data. LEDiL Oy assumes no liability of any kind for the possible deviation from any provided data or any other damage resulting from the usage of the provided data.

The user agrees to this disclaimer and user agreement with the download or usage of the provided files.

#### LEDiL Oy

Joensuunkatu 13  
FI-24240 SALO  
Finland

#### LEDiL Inc.

228 West Page Street  
Suite D  
Sycamore IL 60178  
USA

#### Local sales and technical support

[www.ledil.com/  
where\\_to\\_buy](http://www.ledil.com/where_to_buy)

#### Shipping locations

Salo, Finland  
Hong Kong, China

#### Distribution Partners

[www.ledil.com/  
where\\_to\\_buy](http://www.ledil.com/where_to_buy)