

Product Description

Qorvo's TGA2622-CP is a packaged high-power X-Band amplifier fabricated on Qorvo's QGaN25 0.25 um GaN on SiC process. Operating from 9 to 10 GHz, the TGA2622-CP achieves 35 W saturated output power, a power-added efficiency of greater than 43 %, and power gain of 27.5 dB.

The TGA2622-CP is packaged in a 10-lead 15x15 mm bolt-down package with a Cu base for superior thermal management. It can support a range of bias voltages and performs well under CW and pulsed conditions. Both RF ports are internally DC blocked and matched to 50 ohms allowing for simple system integration.

The TGA2622-CP is ideally suited for both commercial and defense applications.

Lead free and RoHS compliant.



Functional Block Diagram

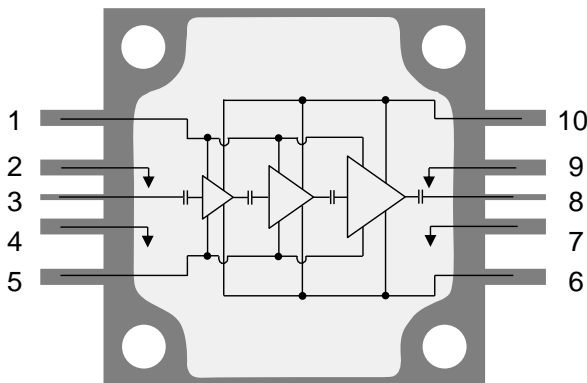

Product Features

- Frequency Range: 9 – 10 GHz
- P_{SAT} : 45.5 dBm @ $P_{IN} = 18$ dBm
- PAE: > 43 % @ $P_{IN} = 18$ dBm
- Power Gain: 27.5 dB @ $P_{IN} = 18$ dBm
- Bias: $V_D = 28$ V, $I_{DQ} = 290$ mA, $V_G = -2.7$ V typical, pulsed ($PW = 100$ μ s, DC = 10 %)
- Package Dimensions: 15.2 x 15.2 x 3.5 mm
- Package base is pure Cu offering superior thermal management

Performance is typical across frequency. Please reference electrical specification table and data plots for more details

Applications

- Weather and Marine Radar.

Ordering Information

Part No.	Description
TGA2622-CP	9 – 10 GHz 35 W GaN Power Amplifier
1113526	TGA2622-CP Evaluation Board (EVB)

Absolute Maximum Ratings

Parameter	Value / Range
Drain Voltage (V_D)	40 V
Gate Voltage Range (V_G)	-8 to 0 V
Drain Current (I_D)	4.3 A
Gate Current (I_G)	See plot page 11
Power Dissipation (P_{DISS}), 85 °C	107 W
Input Power, CW, 50 Ω , (P_{IN})	24 dBm
Input Power, CW, VSWR 3:1, $V_D = 28$ V, 85 °C, (P_{IN})	24 dBm
Mounting Temperature (30 Seconds)	260 °C
Storage Temperature	-55 to 150 °C

Operation of this device outside the parameter ranges given above may cause permanent damage. These are stress ratings only, and functional operation of the device at these conditions is not implied.

Recommended Operating Conditions

Parameter	Value / Range
Drain Voltage (V_D) pulsed: PW = 100 μ s, DC = 10 %	28 V
Drain Current (I_{DQ})	290 mA
Gate Voltage (V_G)	-2.7 V (Typ.)
Temperature (T_{BASE})	-40 to 85 °C

Electrical specifications are measured at specified test conditions. Specifications are not guaranteed over all recommended operating conditions.

Electrical Specifications

Parameter	Min	Typ	Max	Units
Operational Frequency Range	9		10	GHz
Small Signal Gain		30		dB
Input Return Loss		> 11		dB
Output Return Loss		> 8		dB
Output Power @ $P_{IN} = 18$ dBm		45.5		dBm
Power Added Efficiency @ $P_{IN} = 18$ dBm		> 43		%
Power Gain @ $P_{IN} = 18$ dBm		27.5		dB
Output Power Temperature Coefficient (25 °C to 85 °C only)	Pulsed	-0.019		dBm/°C
	CW	-0.023		
Recommended Operating Voltage	20	28	32	V

Test conditions unless otherwise noted: 25 °C, $V_D = 28$ V (PW = 100 μ s, DC = 10 %), $I_{DQ} = 290$ mA, $V_G = -2.7$ V typical.

Typical Performance – Large Signal (Pulsed)

Conditions unless otherwise specified: $V_D = 28\text{ V}$, $I_{DQ} = 290\text{ mA}$, $V_G = -2.7\text{ V}$ typical.

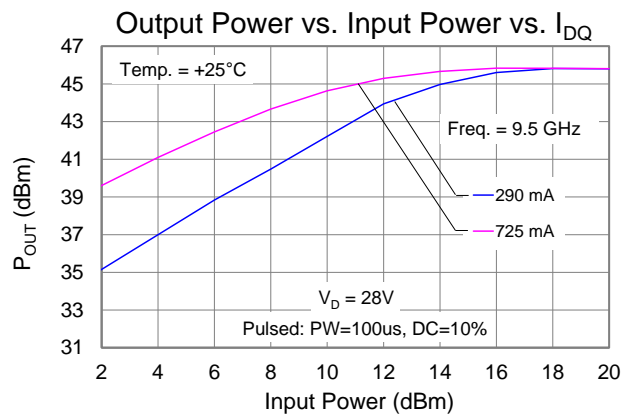
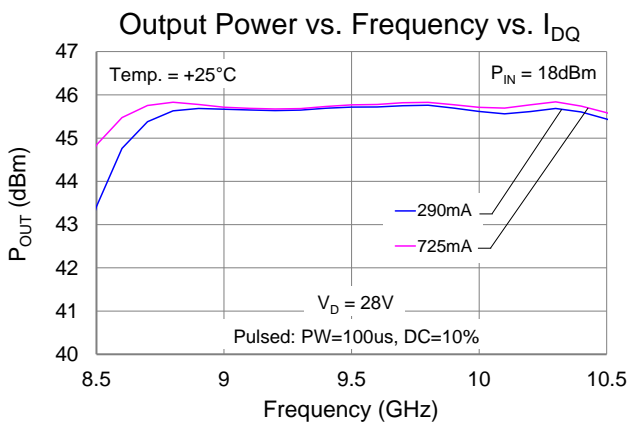
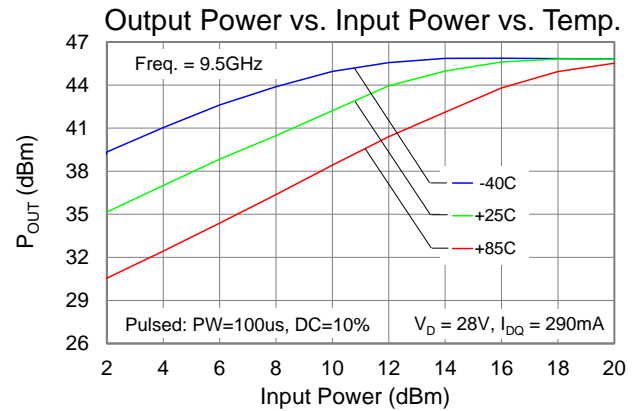
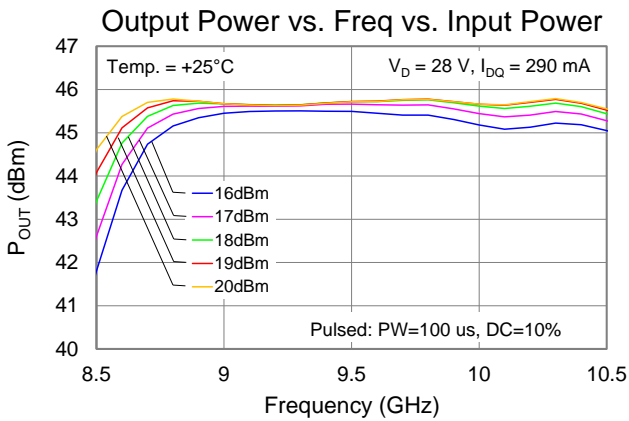
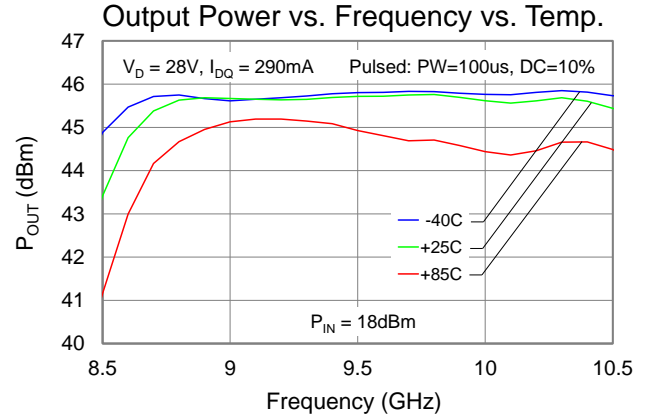
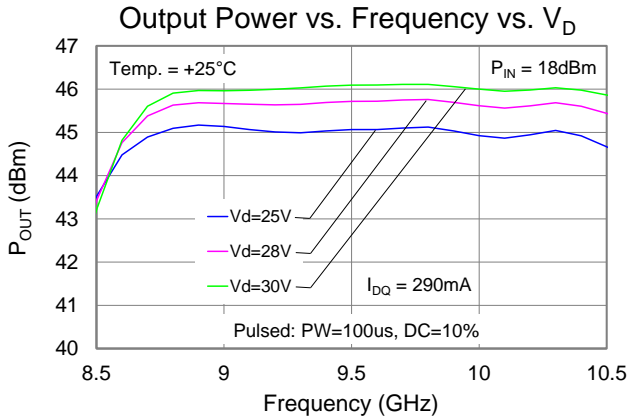

Typical Performance – Large Signal (Pulsed)

Conditions unless otherwise specified: $V_D = 28\text{ V}$, $I_{DQ} = 290\text{ mA}$, $V_G = -2.7\text{ V}$ typical.

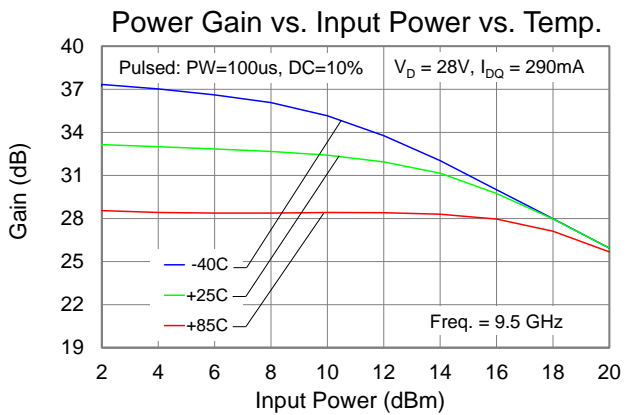
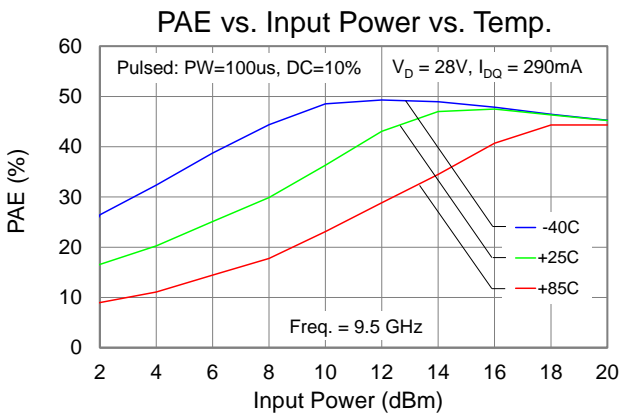
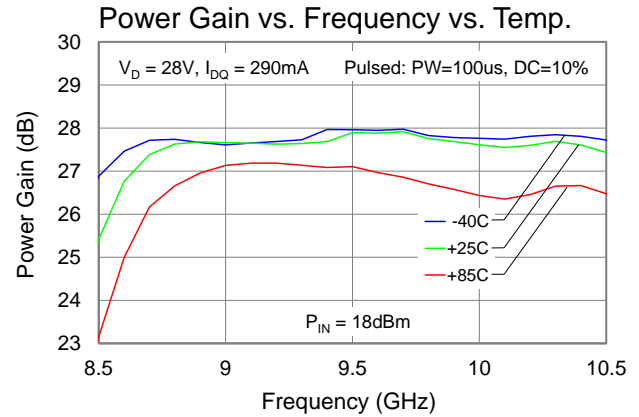
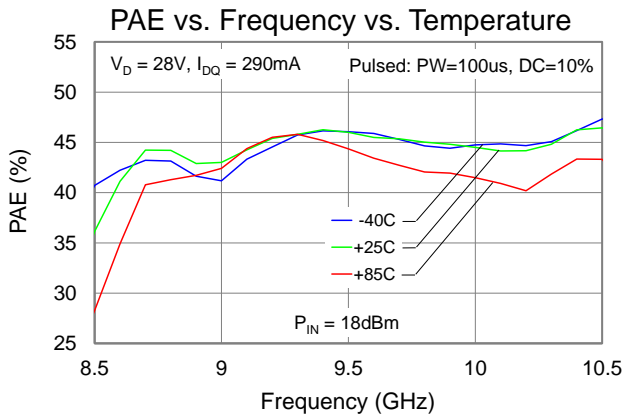
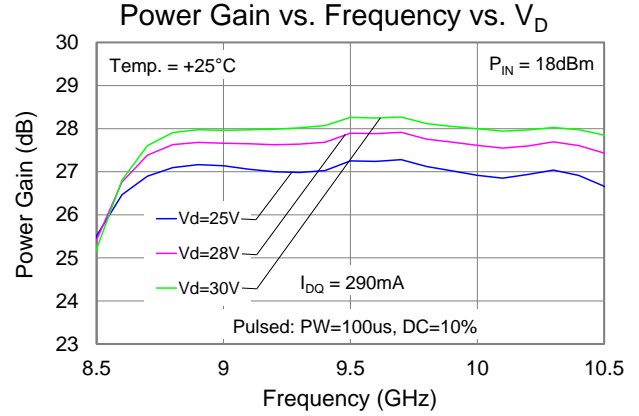
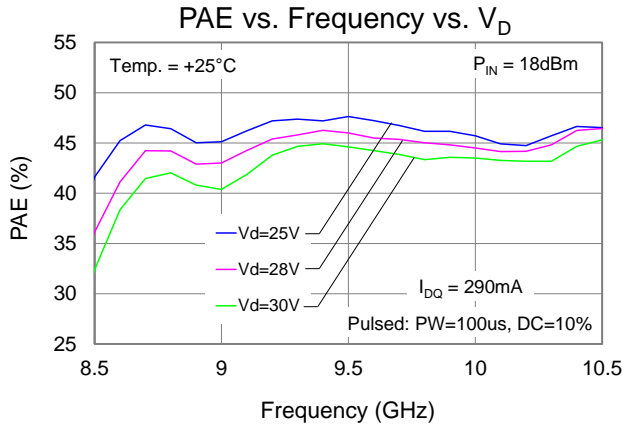

Typical Performance – Large Signal (Pulsed)

Conditions unless otherwise specified: $V_D = 28\text{ V}$, $I_{DQ} = 290\text{ mA}$, $V_G = -2.7\text{ V}$ typical.

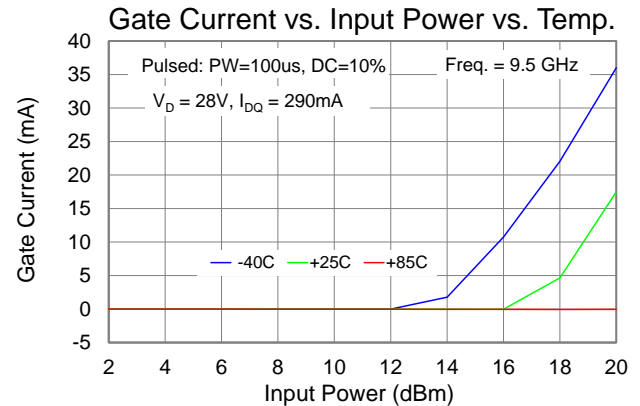
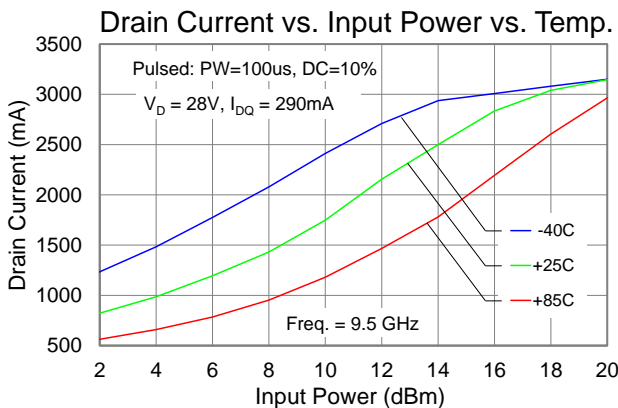
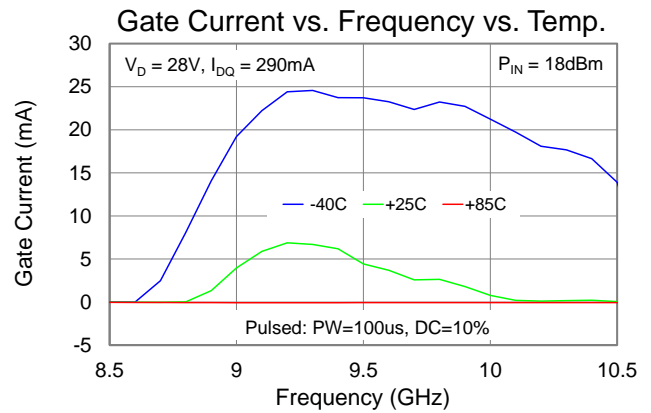
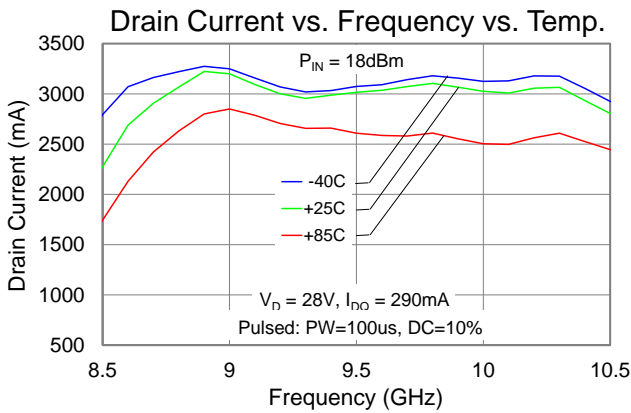
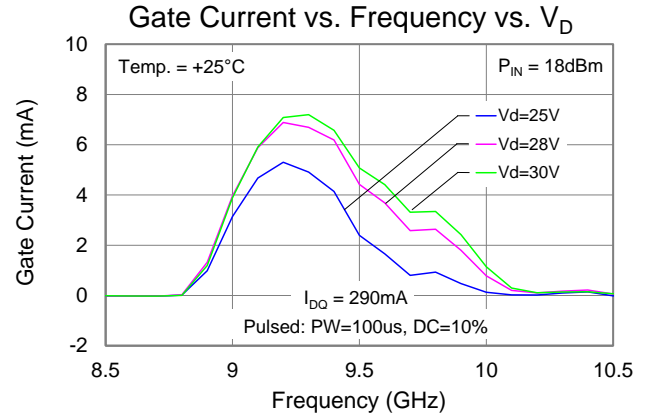
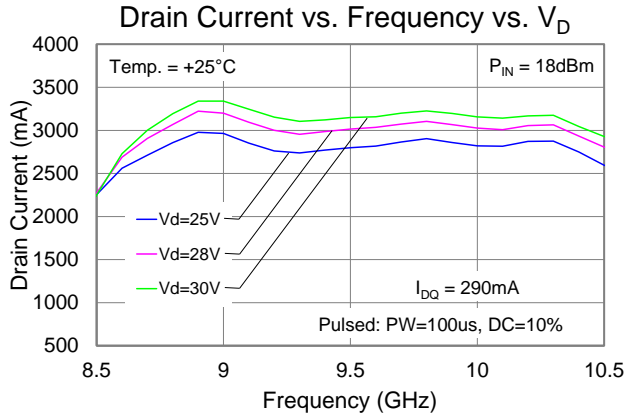

Performance Plots – Large Signal (CW)

Conditions unless otherwise specified: $V_D = 28\text{ V}$, $I_{DQ} = 290\text{ mA}$, $V_G = -2.7\text{ V}$ typical.

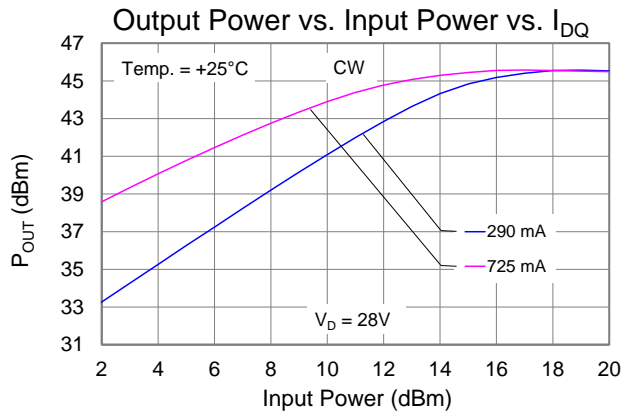
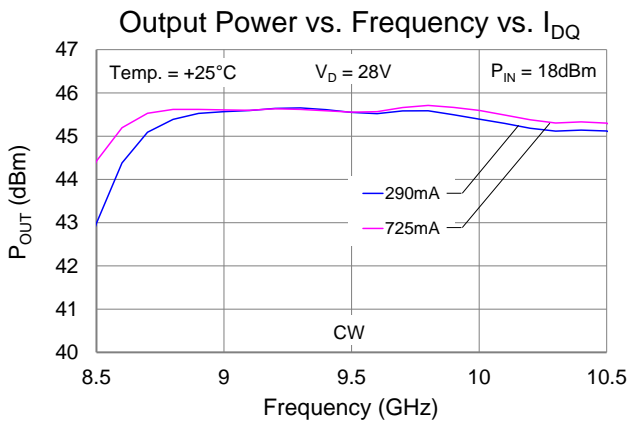
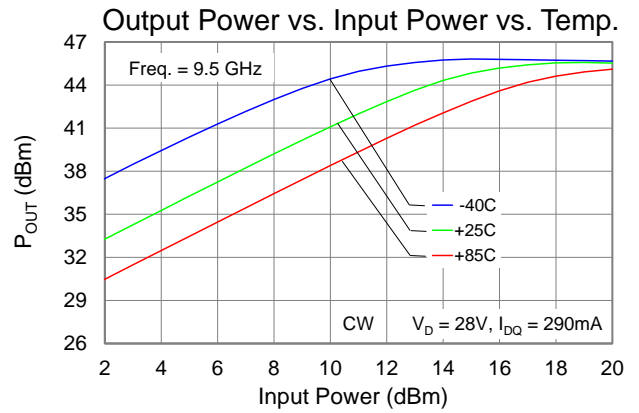
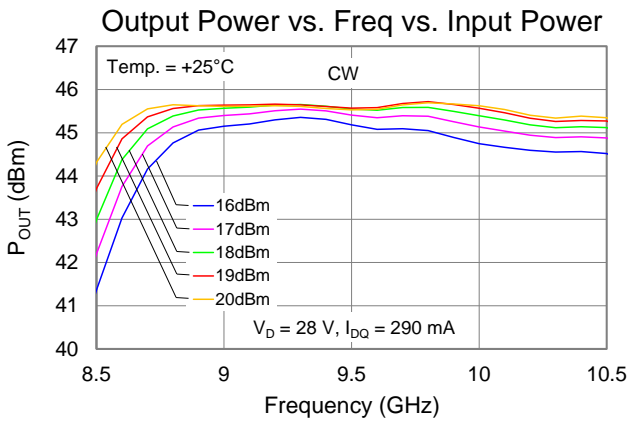
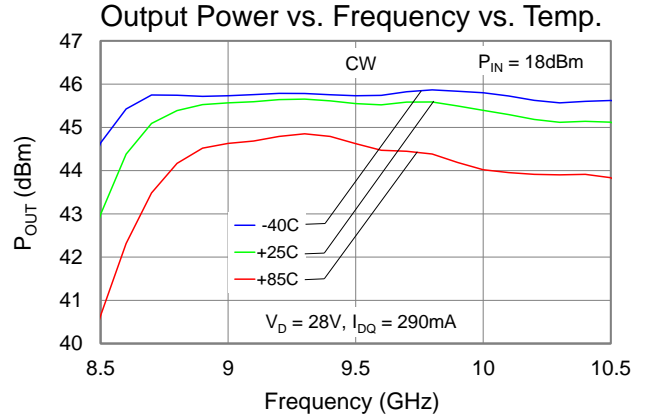
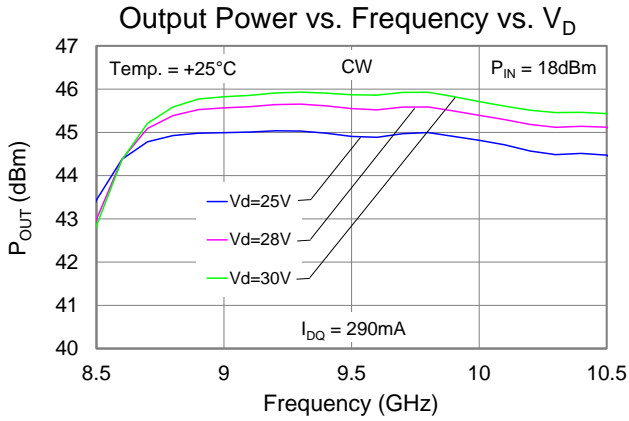

Performance Plots – Large Signal (CW)

Conditions unless otherwise specified: $V_D = 28\text{ V}$, $I_{DQ} = 290\text{ mA}$, $V_G = -2.7\text{ V}$ typical.

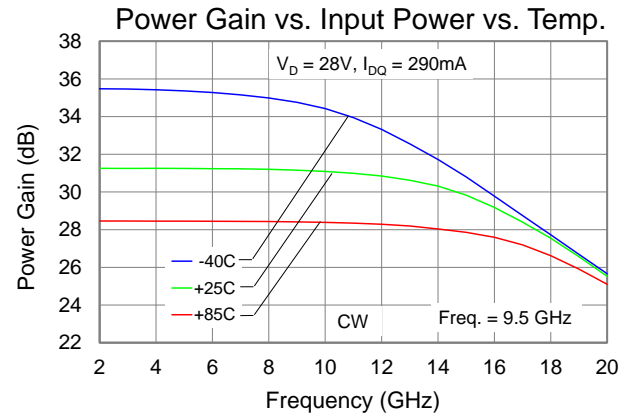
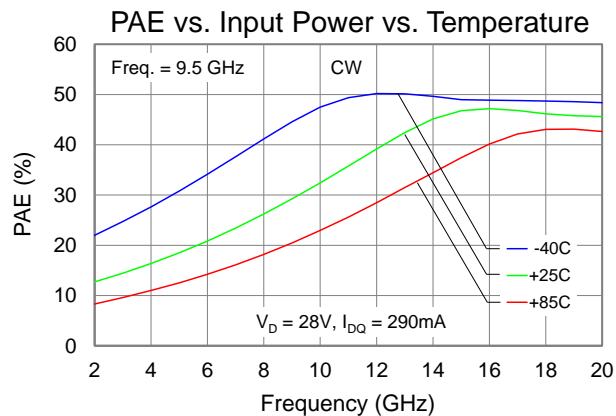
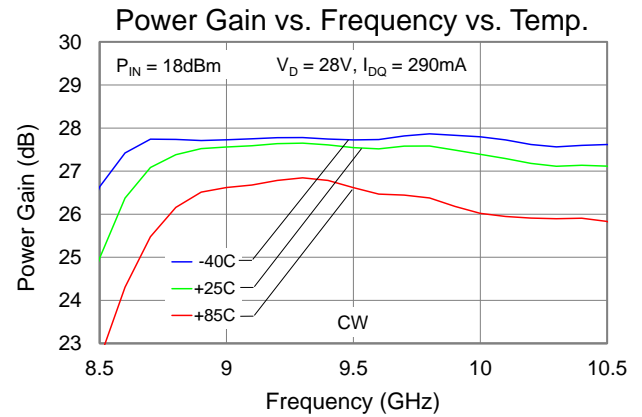
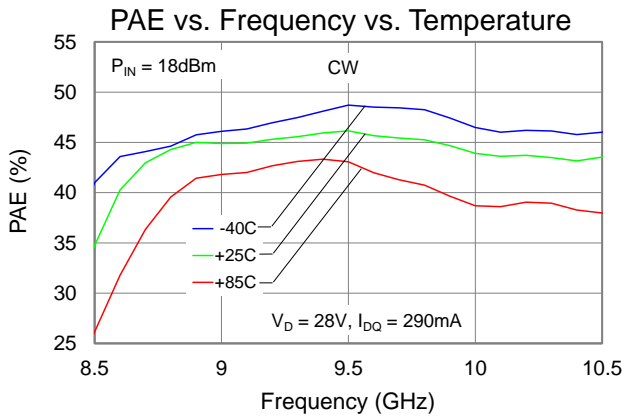
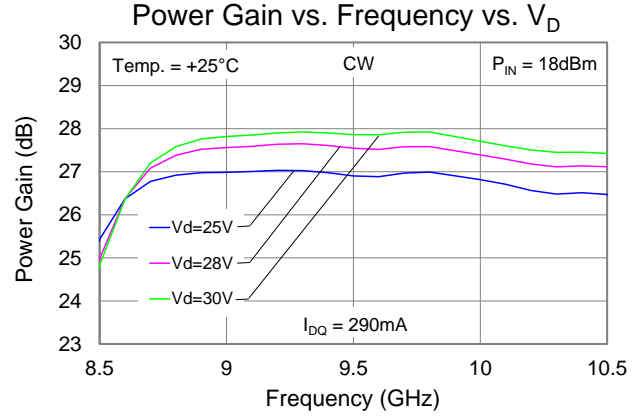
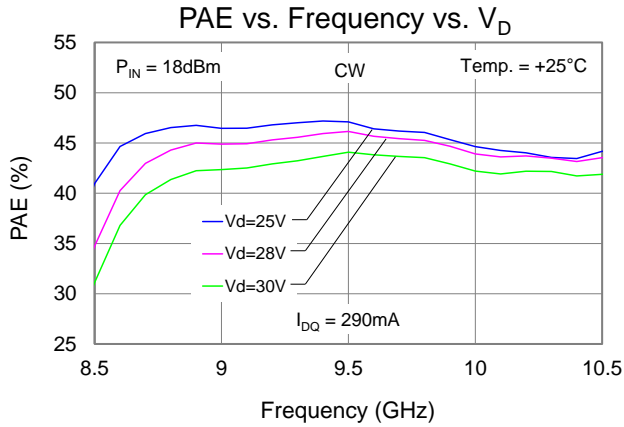

Performance Plots – Large Signal (CW)

Conditions unless otherwise specified: $V_D = 28\text{ V}$, $I_{DQ} = 290\text{ mA}$, $V_G = -2.7\text{ V}$ typical.

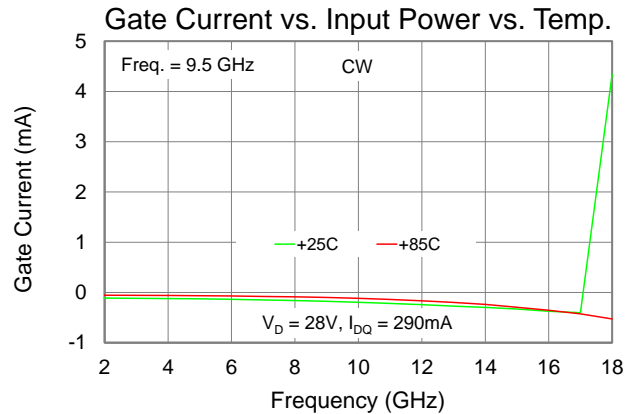
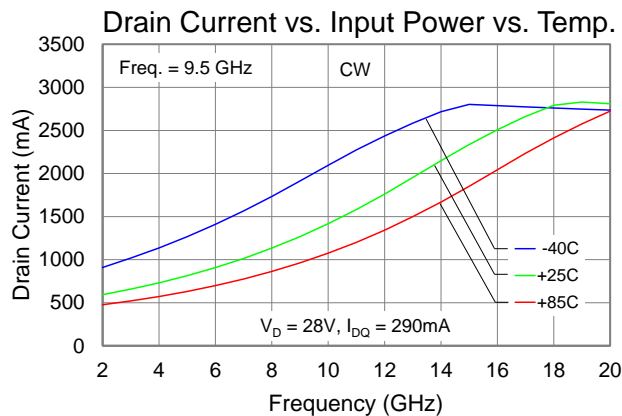
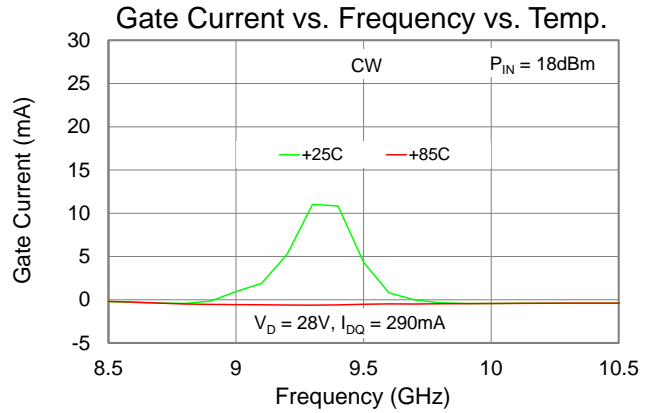
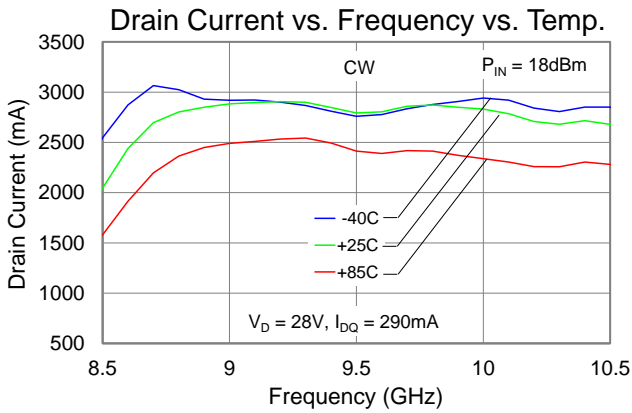
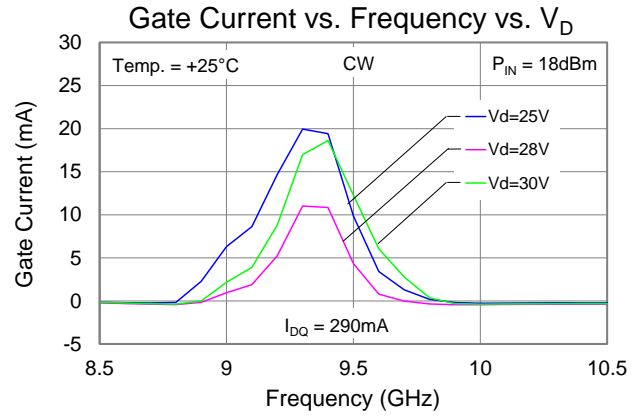
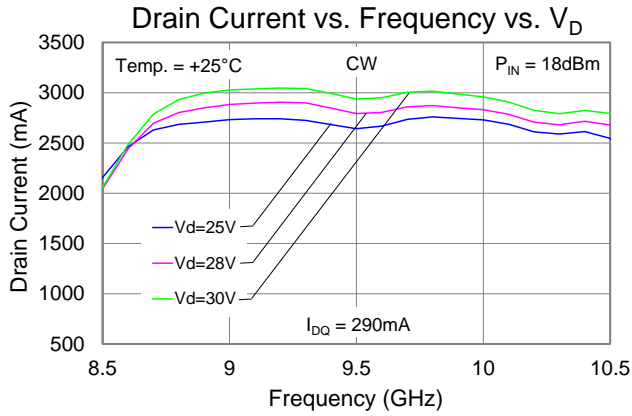

Typical Performance – Linearity (CW)

Conditions unless otherwise specified: $V_D = 28\text{ V}$, $I_{DQ} = 290\text{ mA}$, $V_G = -2.7\text{ V}$ typical.

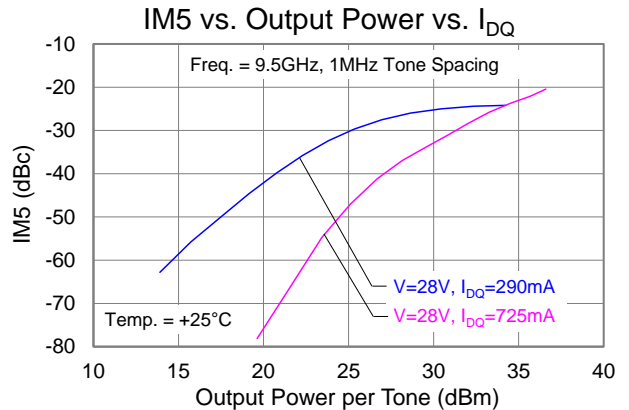
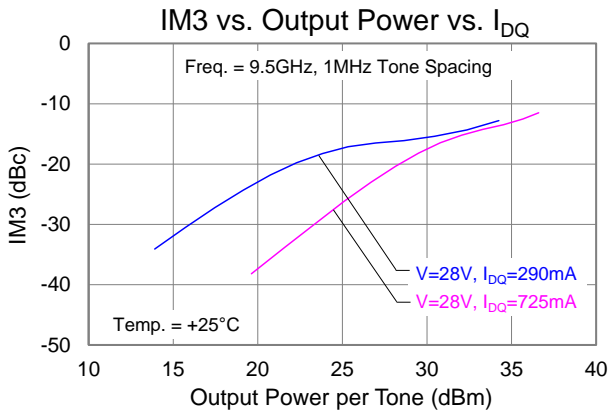
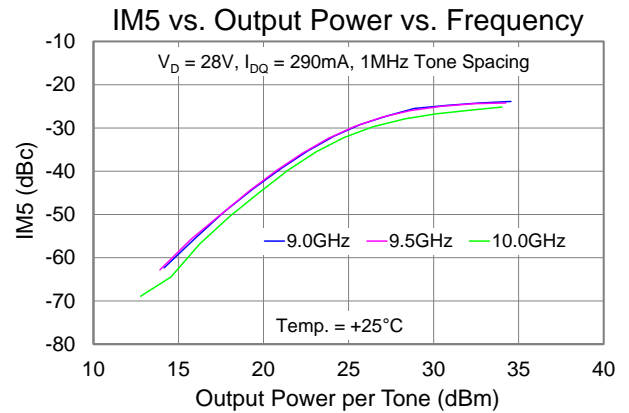
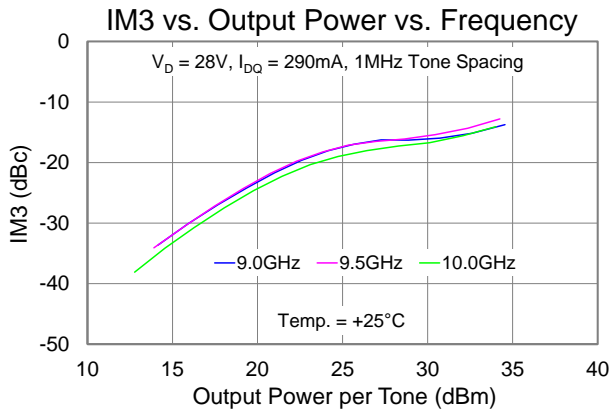
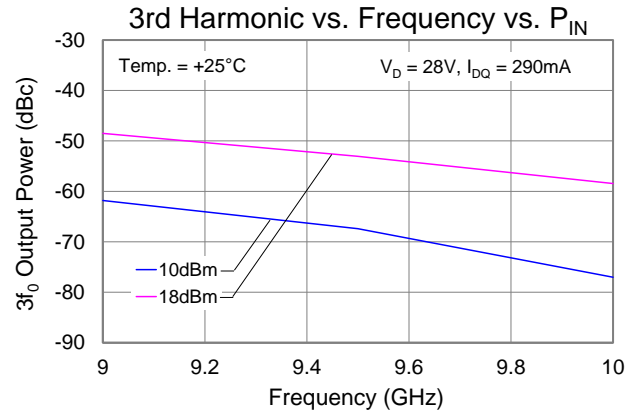
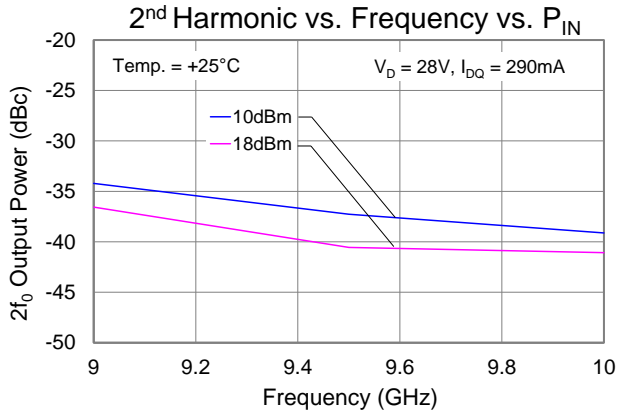

Typical Performance – Small Signal (CW)

Conditions unless otherwise specified: $V_D = 28\text{ V}$, $I_{DQ} = 290\text{ mA}$, $V_G = -2.7\text{ V}$ typical.

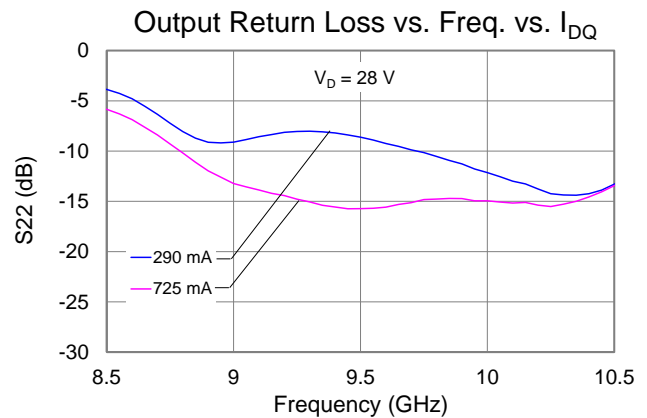
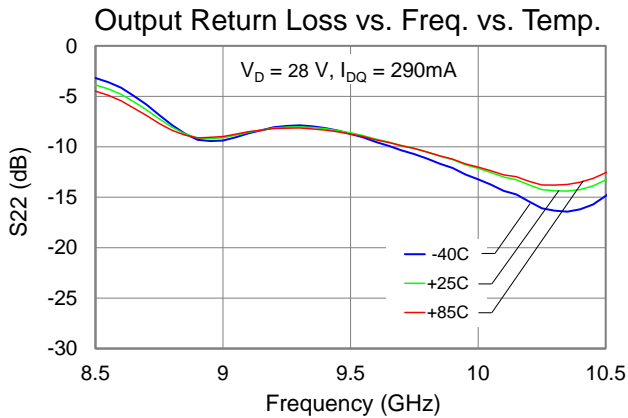
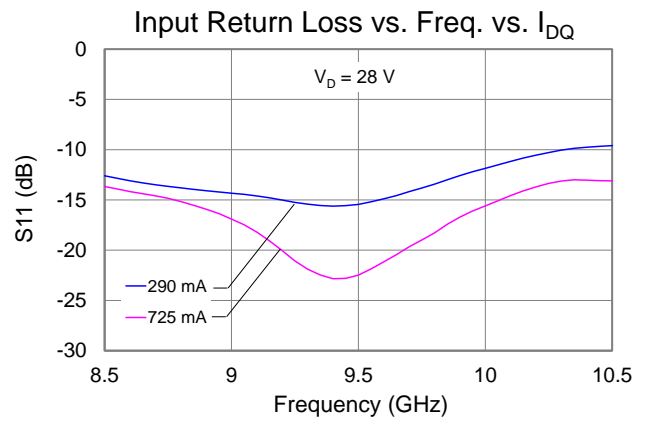
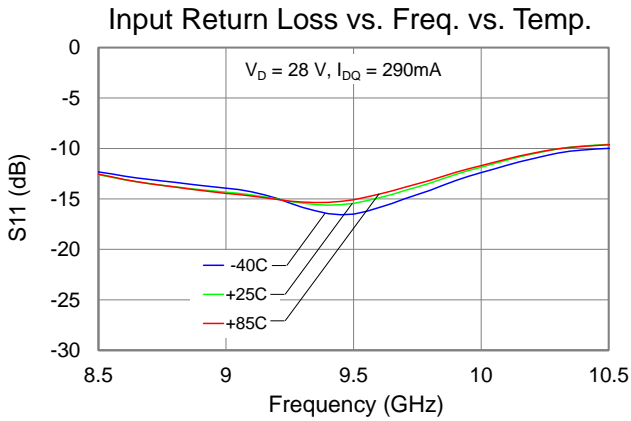
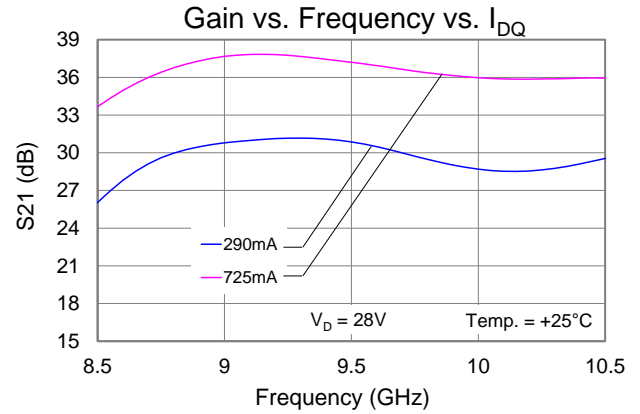
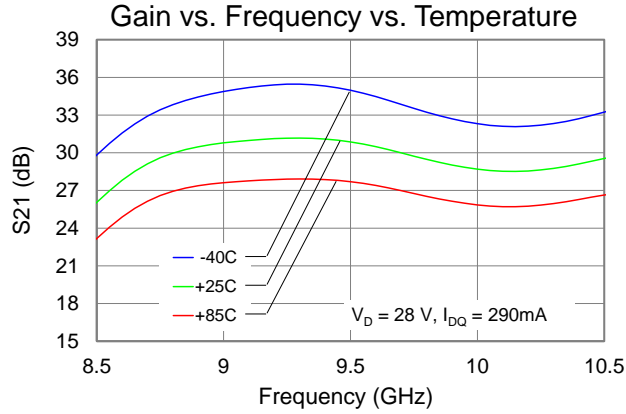

Thermal and Reliability Information

Parameter	Test Conditions	Value	Units
Thermal Resistance (θ_{JC}) ⁽¹⁾	CW, $V_D = 28\text{ V}$, $I_{DQ} = 290\text{ mA}$,	1.222	$^{\circ}\text{C}/\text{W}$
Channel Temperature (T_{CH}) (under RF drive)	$T_{BASE} = 85^{\circ}\text{C}$, $V_D = 28\text{ V}$, $I_{D_Drive} = 2.7\text{ A}$ $P_{IN} = 20\text{ dBm}$, $P_{OUT} = 44.8\text{ dBm}$, $P_{DISS} = 45\text{ W}$	140	$^{\circ}\text{C}$
Thermal Resistance (θ_{JC}) ⁽¹⁾	$V_D = 28\text{ V}$, $I_{DQ} = 290\text{ mA}$,	0.788	$^{\circ}\text{C}/\text{W}$
Channel Temperature (T_{CH}) (under RF drive)	(Pulsed: $PW = 100\ \mu\text{s}$, $DC = 10\%$), $T_{BASE} = 85^{\circ}\text{C}$, $V_D = 28\text{ V}$, $I_{D_Drive} = 3.2\text{ A}$ $P_{IN} = 20\text{ dBm}$, $P_{OUT} = 45.6\text{ dBm}$, $P_{DISS} = 52\text{ W}$	126	$^{\circ}\text{C}$

Notes:

1. Thermal resistance measured to back of package.
2. Refer to the following document: [GaN Device Channel Temperature, Thermal Resistance, and Reliability Estimates](#)

Power Dissipation and Maximum Gate Current

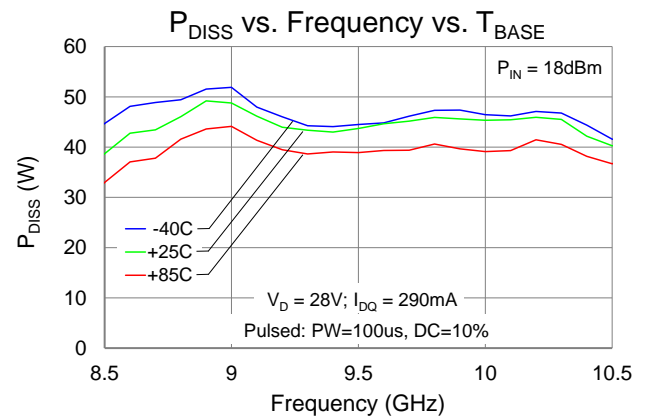
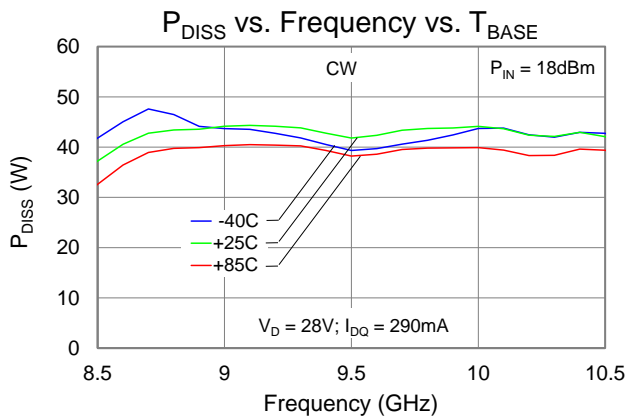
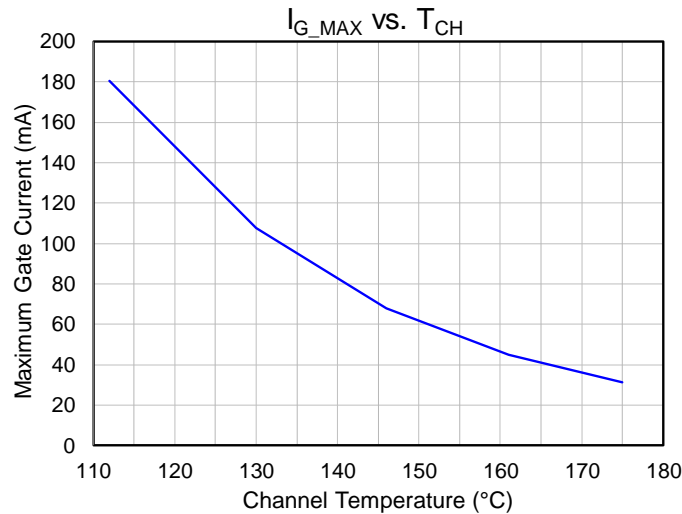

Applications Information and Pin Layout

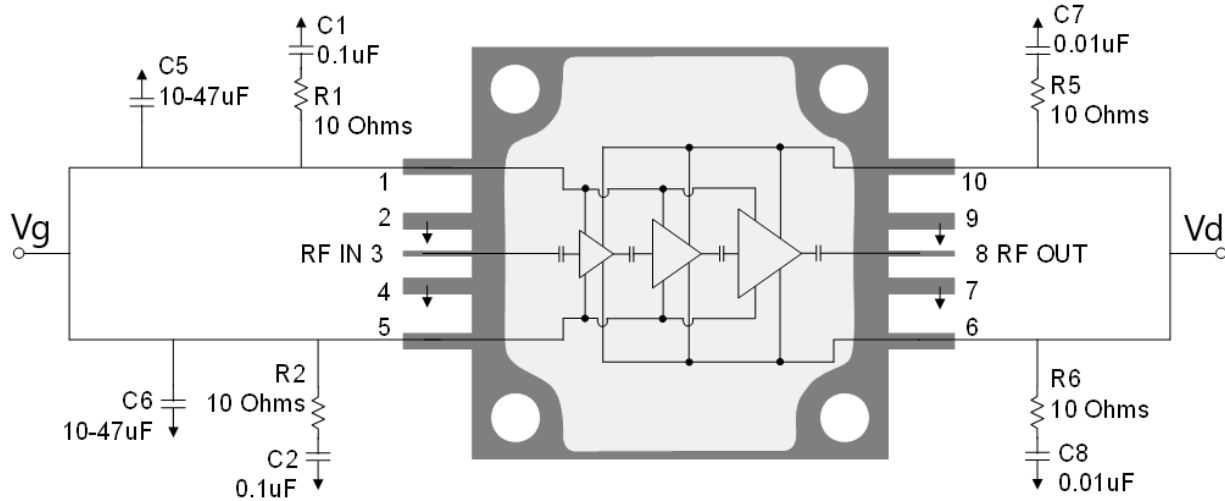

Bias Up Procedure

1. Set I_D limit to 3.5 A, I_G limit to 25 mA
2. Apply -5 V to V_G
3. Apply $+28\text{ V}$ to V_D ; ensure I_{DQ} is approx. 0 mA
4. Adjust V_G until $I_{DQ} = 290\text{ mA}$ ($V_G \sim -2.7\text{ V Typ.}$).
5. Turn on RF supply

Bias Down Procedure

1. Turn off RF supply
2. Reduce V_G to -5 V ; ensure I_{DQ} is approx. 0 mA
3. Set V_D to 0 V
4. Turn off V_D supply
5. Turn off V_G supply

Pin Description

Pad No.	Symbol	Description
1, 5	V_G	Gate Voltage; Bias network is required; must be biased from both sides; see recommended Application Information above.
3	RF_{IN}	Output; matched to $50\ \Omega$; DC blocked
2, 4, 7, 9	GND	Must be grounded on the PCB.
6, 10	V_D	Drain voltage; Bias network is required; must be biased from both sides; see recommended Application Information above.
8	RF_{OUT}	Input; matched to $50\ \Omega$; DC blocked

Evaluation Board (EVB)

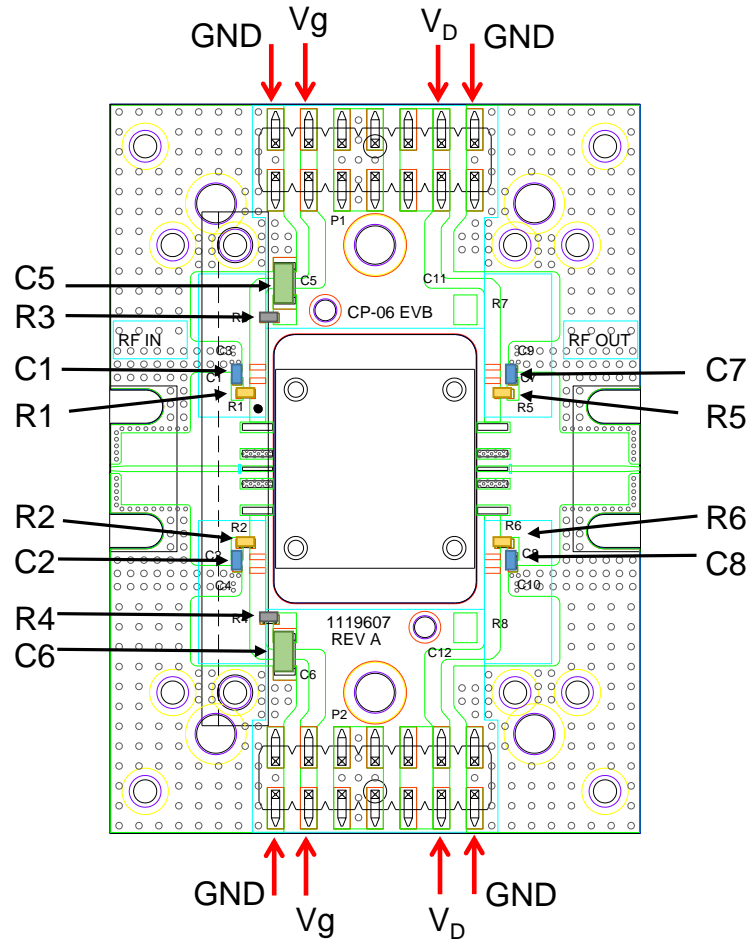

NOTES:

- (1) Both Top and Bottom V_d and V_g must be biased.
- (2) PCB is made from Rogers 4003C dielectric, 0.008 inch thick. 0.5 oz. copper both sides.

Bill of Materials

Reference Des.	Value	Description	Manuf.	Part Number
C1, C2	0.1 uF	Cap, 0402, 50 V, 10%, X7R	Various	
C5, C6	10-47 uF	Cap, 1206, 50 V, 20%, X5R (10 V is OK)	Various	
C7, C8	0.01 uF	Cap, 0402, 50V, 10%, X7R	Various	
R1, R2, R5, R6	10 Ω	Res, 0402, 50V, 5%	Various	
R3, R4	0 Ω	Res, 0402, jumper required for the above EVB design	Various	

Assembly Notes

1. Carefully clean the PC board and package leads with alcohol. Allow it to dry fully.
2. To improve the thermal and RF performance, Qorvo recommends attaching a heat sink to the bottom of the PCB and apply thermal compound (Arctic Silver 5 recommended) or 4 mil indium shim between the heat sink and the package.
3. (The following is for *information only*. There are many variables in a second level assembly that Qorvo does not control, so Qorvo does not recommend an absolute torque value.) Use screws to attach the component to the heat sink. A suggested torque value is 16 in-oz. for a 0-80 screw. Start with screws finger tight, then torque to 8 in-oz., then torque to final value. Use the following tightening pattern:

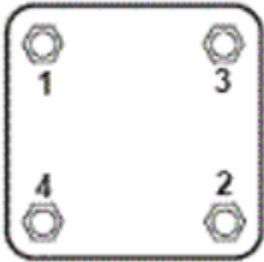

4. Apply no-flux solder to each pin of the TGA2622-CP. The component leads should be manually soldered, and the package cannot be subjected to conventional reflow processes. The use of no-clean solder to avoid washing after soldering is recommended.

Mechanical Information

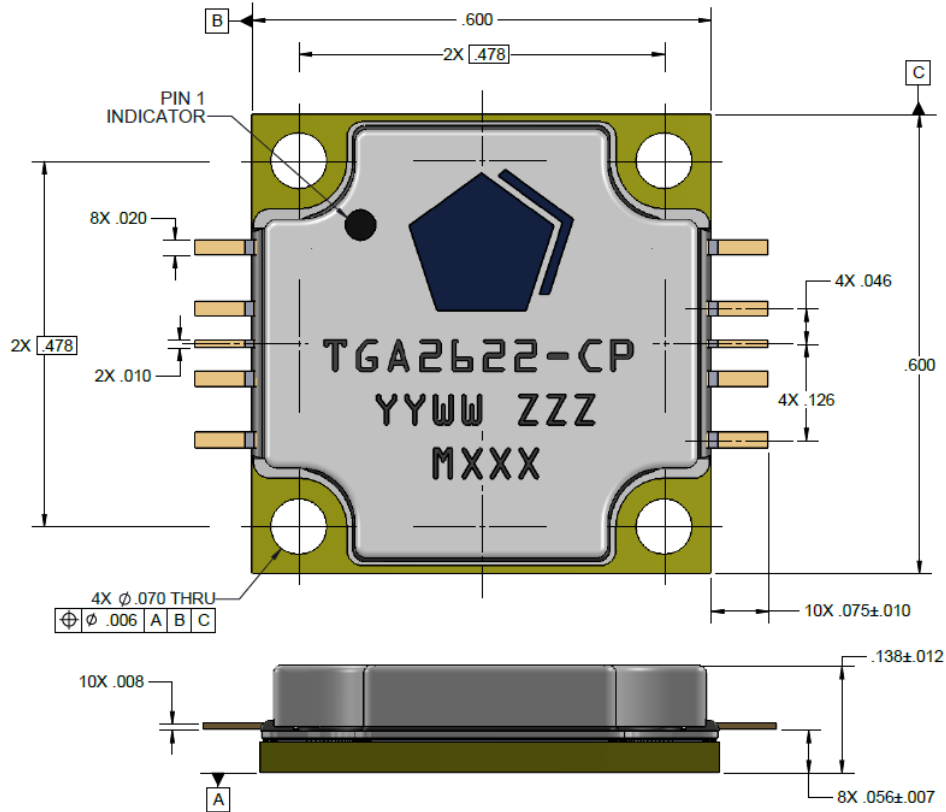

Units: inches

Tolerances: unless specified

x.xx = ± 0.01

x.xxx = ± 0.005

Materials:

Base: Copper

Lid: Plastic

All metalized features are gold plated

Part is epoxy sealed

Marking:

2622: Part number

YY: Part Assembly year

WW: Part Assembly week

ZZZ: Serial Number

MXXX: Batch ID

Handling Precautions

Parameter	Rating	Standard
ESD – Human Body Model (HBM)	1B	ESDA / JEDEC JS-001-2014
ESD – Charged Device Model (CDM)	C1	ESDA / JEDEC JS-002-2014
MSL – Moisture Sensitivity Level	N/A	



Caution!
ESD-Sensitive Device

Solderability

The component leads should be manually soldered, and the package cannot be subjected to conventional reflow processes. Soldering of the component leads is compatible with the latest version of J-STD-020, lead-free solder, 260 °C. The use of no-clean solder to avoid washing after soldering is recommended.

RoHS Compliance

This product is compliant with the 2011/65/EU RoHS directive (Restrictions on the Use of Certain Hazardous Substances in Electrical and Electronic Equipment), as amended by Directive 2015/863/EU. This product also has the following attributes:

- Lead Free
- Halogen Free (Chlorine, Bromine)
- Antimony Free
- TBBP-A (C₁₅H₁₂Br₄O₂) Free
- PFOS Free
- SVHC Free

Contact Information

For the latest specifications, additional product information, worldwide sales and distribution locations:

- Web:** www.qorvo.com
Tel: 1-844-890-8163
Email: customer.support@qorvo.com

Important Notice

The information contained herein is believed to be reliable; however, Qorvo makes no warranties regarding the information contained herein and assumes no responsibility or liability whatsoever for the use of the information contained herein. All information contained herein is subject to change without notice. Customers should obtain and verify the latest relevant information before placing orders for Qorvo products. The information contained herein or any use of such information does not grant, explicitly or implicitly, to any party any patent rights, licenses, or any other intellectual property rights, whether with regard to such information itself or anything described by such information. **THIS INFORMATION DOES NOT CONSTITUTE A WARRANTY WITH RESPECT TO THE PRODUCTS DESCRIBED HEREIN, AND QORVO HEREBY DISCLAIMS ANY AND ALL WARRANTIES WITH RESPECT TO SUCH PRODUCTS WHETHER EXPRESS OR IMPLIED BY LAW, COURSE OF DEALING, COURSE OF PERFORMANCE, USAGE OF TRADE OR OTHERWISE, INCLUDING THE IMPLIED WARRANTIES OF MERCHANTABILITY AND FITNESS FOR A PARTICULAR PURPOSE.**

Without limiting the generality of the foregoing, Qorvo products are not warranted or authorized for use as critical components in medical, life-saving, or life-sustaining applications, or other applications where a failure would reasonably be expected to cause severe personal injury or death.

Copyright 2019 © Qorvo, Inc. | Qorvo is a registered trademark of Qorvo, Inc.