

PRODUCT NO	DIM H	DIM J	PICK-UP CAP	PACKAGING
10045103-001LF	8.15	2.45	NO	TRAY
10045103-001CLF			YES	TRAY
10045103-001C-TRLF			YES	TAPE & REEL
10045103-002LF	8.45	2.75	NO	TRAY
10045103-002CLF			YES	TRAY
10045103-002C-TRLF			YES	TAPE & REEL
10045103-0021LF	8.45	2.75	YES	TRAY
10045103-0021-TRLF			YES	TAPE & REEL

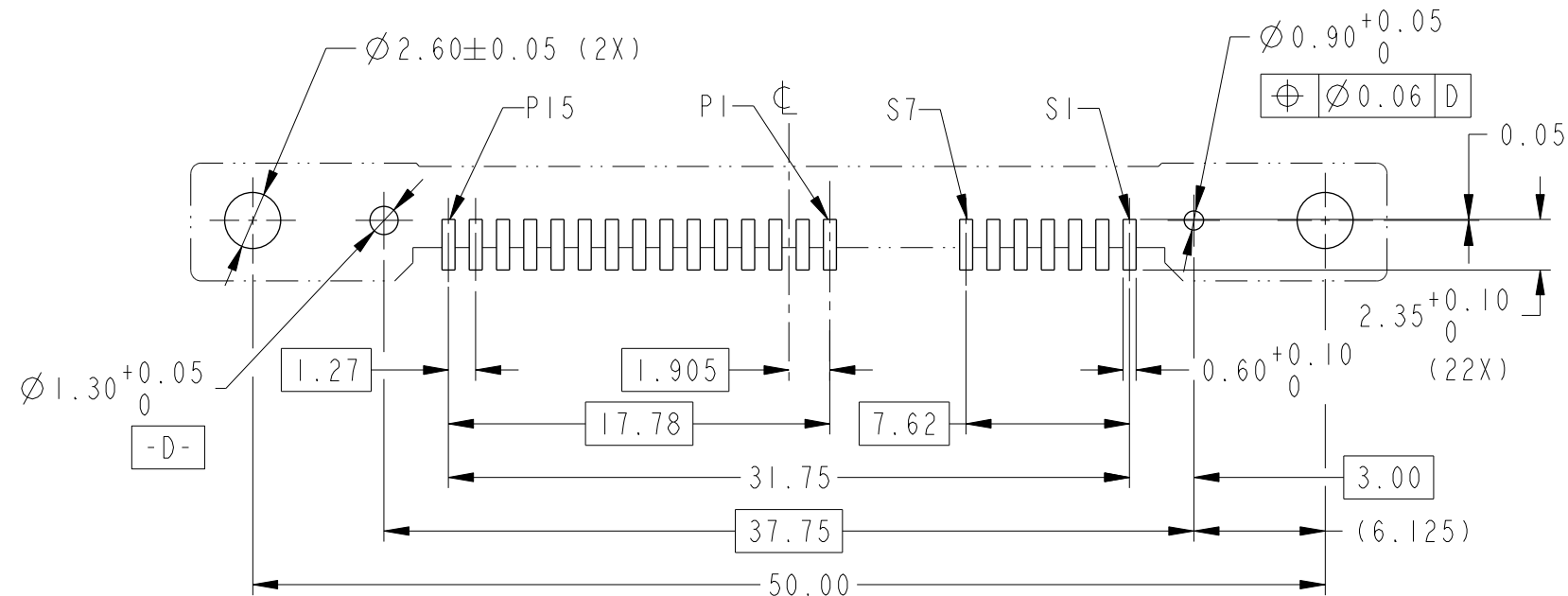

10045103-001/002C

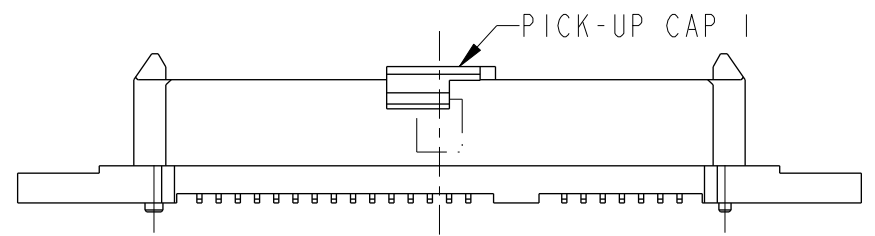
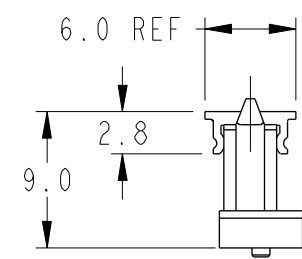
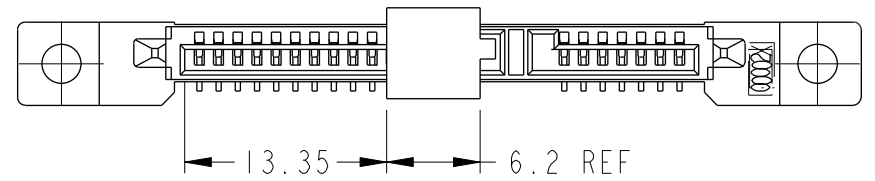

RECOMMENDED PCB LAYOUT

10045103-0021

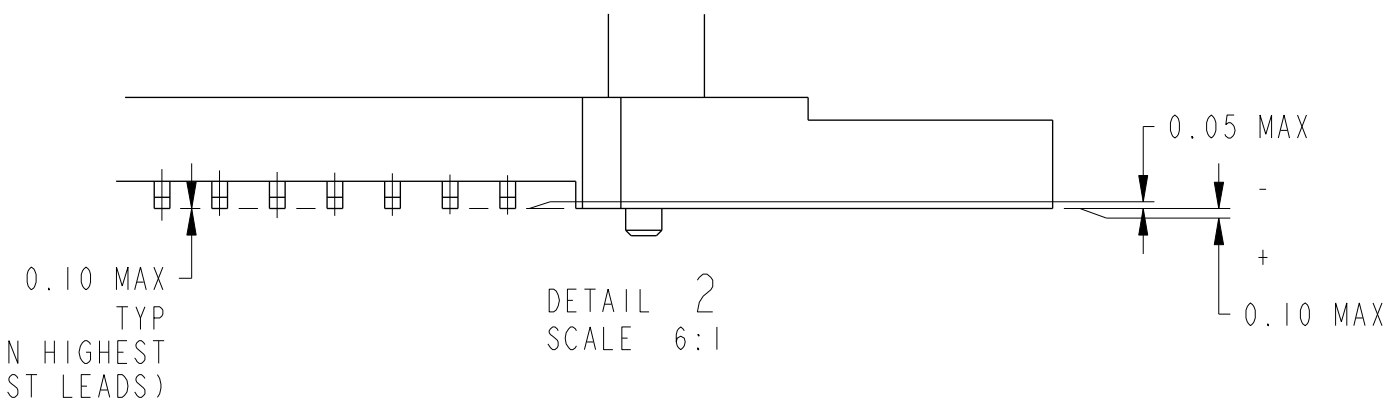
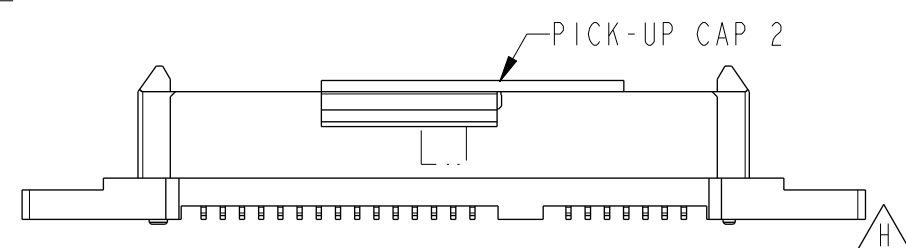
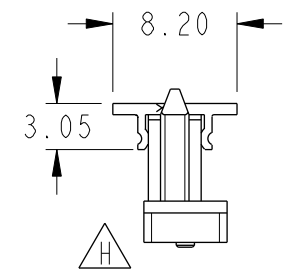

PART WITH PICK-UP CAP, SEE NOTE 8
SCALE 2:1

spec ref	-	dr	Louis Ng	2011/10/03	projection	MM	size	A3	scale	3:1
tolerance std	ISO 406 ISO 1101	eng	Noorhazlinda	2017/03/16			ecn no	ELX-M-25503-1	rel level	Released
surface	linear	chr	-	apppr			Koon-Poh Tay	2017/04/03	product family	S-ATA
	angular	0°	±3°	Amphenol FCI	title		S-ATA COMB RECEP. VERTICAL SMT TYPE ASSY	cat. no.	-	Product - Customer Drw
					dwg no	10045103	rev	H	sheet 2 of 3	

Amphenol FCI
 © 2016 AFCI

NOTES:

- 1. THIS PRODUCT MEETS THE SATA SPEC REV. 1.0a
- 2. MATERIAL :
 - 1) HOUSING : HIGH TEMP THERMOPLASTIC, UL 94V-0
 - COLOR : BLACK
 - 2) TERMINAL : COPPER ALLOY
 - 3) HOLD DOWN : COPPER ALLOY
- 3. FINISH :
 - 1) TERMINAL : 30µ" Au PLATING (CONTACT POINT) OVER 50µ" NICKEL
 - 2) SOLDER TAIL : 100µ" MIN Sn OVER 50µ" NICKEL
 - 3) HOLD DOWN : 100µ" MIN Sn OVER 50µ" NICKEL
- 4. THE HOUSING WILL WITHSTAND EXPOSURE TO 260° C PEAK TEMPERATURE FOR 10 SECONDS IN A CONVECTION, INFRA-RED OR VAPOR PHASE REFLOW OVEN.
- ⑤ THIS PRODUCT MEETS EUROPEAN UNION DIRECTIVES AND OTHER COUNTRY REGULATIONS AS DESCRIBED IN GS-22-008.
- ⑥ THE STD PACKAGING IS IN TRAY UNLESS OTHERWISE SPECIFIED.
- ⑦ IDENTIFICATION NUMBER FOR CONNECTOR HOUSING.
- ⚠ ⑧ PART WITH PICK-UP CAP, P/N XXXXXXXX-XXXX LF
- ⚠ ⑨ FOR TAPE & REEL PACKAGING, SUFFIX "-TR" ADDED. P/N XXXXXXXX-XXXX-TR LF
- ⑩ A ⚠ SYMBOL WILL BE NEXT TO ANY DIMENSION, VIEW, OR NOTE WHICH HAS BEEN MODIFIED WITH THE CURRENT DRAWING REVISION.

Amphenol FCI

© 2016 AFCI

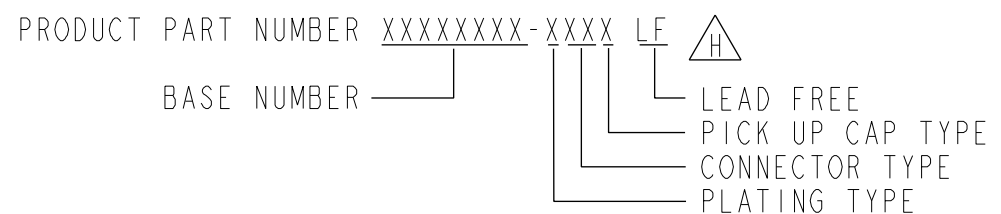

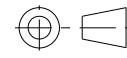
spec ref -		dr Louis Ng 2011/10/03		projection		MM		size A3		scale 2:1	
tolerance std ISO 406 ISO 1101		TOLERANCES UNLESS OTHERWISE SPECIFIED		eng Noorhazlinda 2017/03/16				ecn no ELX-M-25503-1		rel level Released	
surface -		linear		chr -				product family S-ATA		dwg no 10045103	
ISO 1302		angular		appr Koon-Poh Tay 2017/04/03		cat. no. -		Product - Customer Drw		sheet 3 of 3	
		0.X ±-		Amphenol FCI		title S-ATA COMB RECEP. VERTICAL SMT TYPE ASSY					
		0.XX ±0.20									
		0.XXX ±-									
		0° ±3°									