

Plastic Infrared Emitting Diode

OP240 Series

OP245 Series

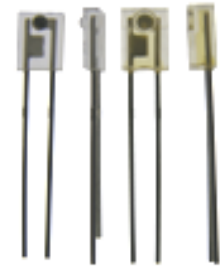

OP240 OP245

Features:

- Wide irradiance pattern
- Side-looking package for space-limited applications
- Wavelength matched to silicon’s peak response
- Mechanically and spectrally matched to other OPTEK products

Description:

Each device in this series is a high intensity gallium aluminum arsenide infrared emitting diode that is suited for use as a PCBoard mounted slotted switch or an easy mount PCBoard interrupter.

Each dome lens **OP240** and **OP245** device is an 890 nm diode that is molded in an IR-transmissive clear epoxy side-looking package. *OP240 is mechanically and spectrally matched to the OP550 and OP560 series of phototransistors. OP245 is mechanically and spectrally matched to the OP555 and OP565 series devices.*

Please refer to Application Bulletins 208 and 210 for additional design information and reliability (degradation) data.

Applications:

- Space-limited applications
- PCBoard mounted slotted switch
- PCBoard interrupter

Ordering Information				
Part Number	LED Peak Wavelength	Lens Type	Total Beam Angle	Lead Length
OP240A	890 nm	Dome	40°	0.50" minimum
OP240B				
OP240C				
OP240D				
OP245A		Recessed		
OP245B				

OP240 (A, B, C, D)

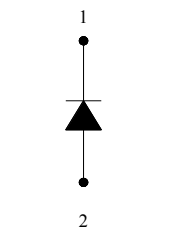
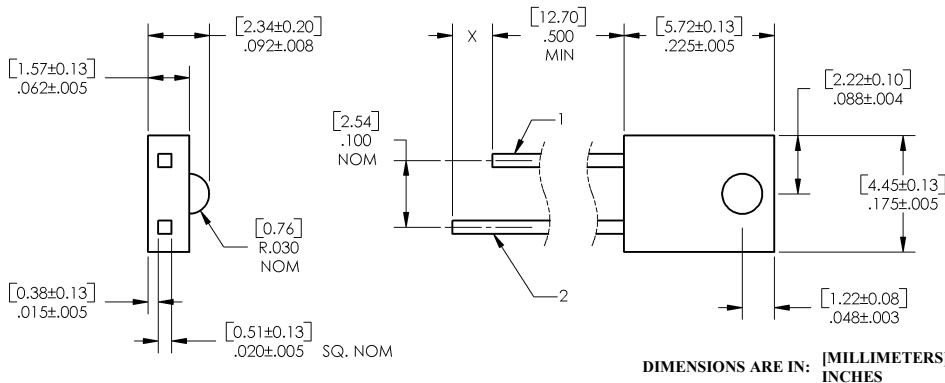

Pin #	LED
1	Cathode
2	Anode

OP245 CONTAINS POLYSULFONE
 To avoid stress cracking, we suggest using ND Industries' **Vibra-Tite** for thread-locking. **Vibra-Tite** evaporates fast without causing structural failure in OPTEK'S molded plastics.



General Note
 TT Electronics reserves the right to make changes in product specification without notice or liability. All information is subject to TT Electronics' own data and is considered accurate at time of going to print.

OPTEK Technology, Inc.
 1645 Wallace Drive, Carrollton, TX 75006 | Ph: +1 972 323 2200
 www.optekinc.com | www.ttelectronics.com

Plastic Infrared Emitting Diode

OP240 Series



Pin #	LED
1	Cathode
2	Anode

CONTAINS POLYSULFONE
 To avoid stress cracking, we suggest using
 ND Industries' **Vibra-Tite** for thread-locking.
Vibra-Tite evaporates fast without causing structural failure in
 OPTEK's molded plastics.

OP245 (A, B, C, D)

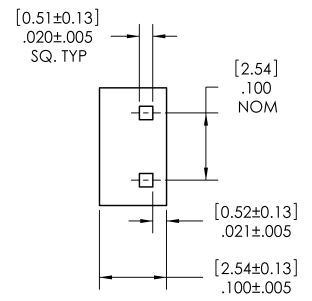
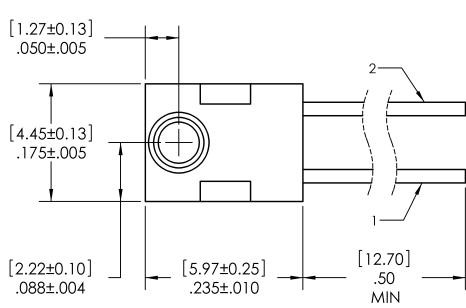

DIMENSIONS ARE [MILLIMETERS INCHES]

General Note

TT Electronics reserves the right to make changes in product specification without notice or liability. All information is subject to TT Electronics' own data and is considered accurate at time of going to print.

OPTEK Technology, Inc.
 1645 Wallace Drive, Carrollton, TX 75006 | Ph: +1 972 323 2200
 www.optekinc.com | www.ttelectronics.com

Plastic Infrared Emitting Diode

OP240 Series



Electrical Specifications

Absolute Maximum Ratings ($T_A = 25^\circ\text{C}$ unless otherwise noted)	
Storage and Operating Temperature Range	-40°C to $+100^\circ\text{C}$
Reverse Voltage	2.0 V
Continuous Forward Current	50 mA
Peak Forward Current	3.0 A
Lead Soldering Temperature [1/16 inch (1.6 mm) from case for 5 seconds with soldering iron]	$260^\circ\text{C}^{(1)}$
Power Dissipation	100 mW ⁽²⁾

Electrical Characteristics ($T_A = 25^\circ\text{C}$ unless otherwise noted)						
SYMBOL	PARAMETER	MIN	TYP	MAX	UNITS	TEST CONDITIONS
Input Diode						
$E_{E(APT)}$	Apertured Radiant Incidence					$I_F = 20\text{ mA}^{(3)}$
	OP240A, OP245A	0.60	-	-	mW/ cm ²	
	OP240B, OP245B	0.40	-	1.20		
	OP240C	0.20	-	0.86		
OP240D	0.05	-	-			
V_F	Forward Voltage	-	-	1.80	V	$I_F = 20\text{ mA}$
I_R	Reverse Current	-	-	100	μA	$V_R = 2.0\text{ V}$
λ_p	Wavelength at Peak Emission	-	890	-	nm	$I_F = 10\text{ mA}$
B	Spectral Bandwidth between Half Power Points	-	80	-	nm	$I_F = 10\text{ mA}$
$\Delta\lambda_p/\Delta T$	Spectral Shift with Temperature	-	± 0.18	-	nm/ $^\circ\text{C}$	$I_F = \text{Constant}$
θ_{HP}	Emission Angle at Half Power Points	-	40	-	Degree	$I_F = 20\text{ mA}$
t_r	Output Rise Time	-	500	-	ns	$I_{F(PK)}=100\text{ mA}$, PW=10 μs , and D.C.=10.0%
t_f	Output Fall Time	-	250	-	ns	$I_{F(PK)}=100\text{ mA}$, PW=10 μs , and D.C.=10.0%

Notes:

1. RMA flux is recommended. Duration can be extended to 10 seconds maximum when flow soldering. A maximum of 20 grams force may be applied to the leads when soldering.
2. Derate linearly 1.33 mW/ $^\circ\text{C}$ above 25°C .
3. $E_{E(APT)}$ is a measurement of the average apertured radiant energy incident upon a sensing area 0.180" (4.57 mm) in diameter perpendicular to and centered on the mechanical axis of the lens and 0.653" (6.60 mm) from the lens tip. $E_{E(APT)}$ is not necessarily uniform within the measured area.

General Note

TT Electronics reserves the right to make changes in product specification without notice or liability. All information is subject to TT Electronics' own data and is considered accurate at time of going to print.

OPTEK Technology, Inc.
1645 Wallace Drive, Carrollton, TX 75006 | Ph: +1 972 323 2200
www.optekinc.com | www.ttelectronics.com

Plastic Infrared Emitting Diode

OP240 Series



Performance OP240, OP245 (A, B, C, D)

Forward Voltage vs Forward Current vs Temperature

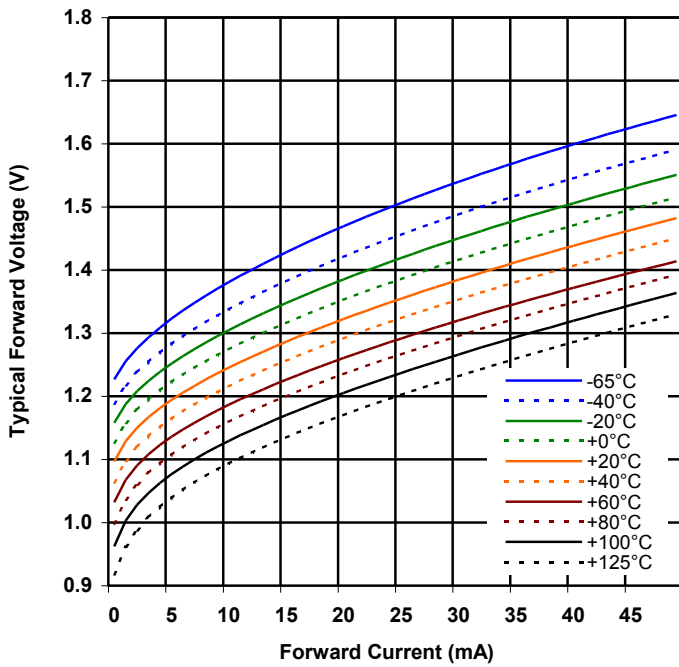

Optical Power vs I_F vs Temp

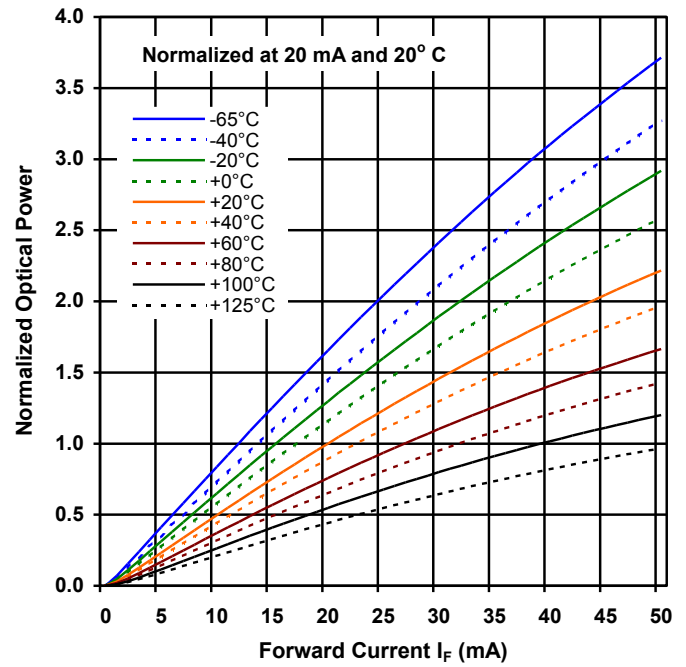

Distance vs Output Power vs Forward Current

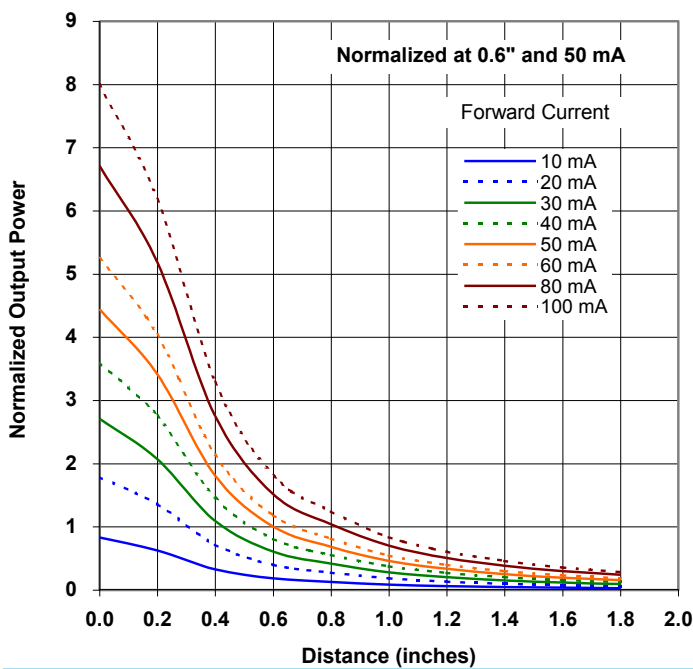

Beam Angle

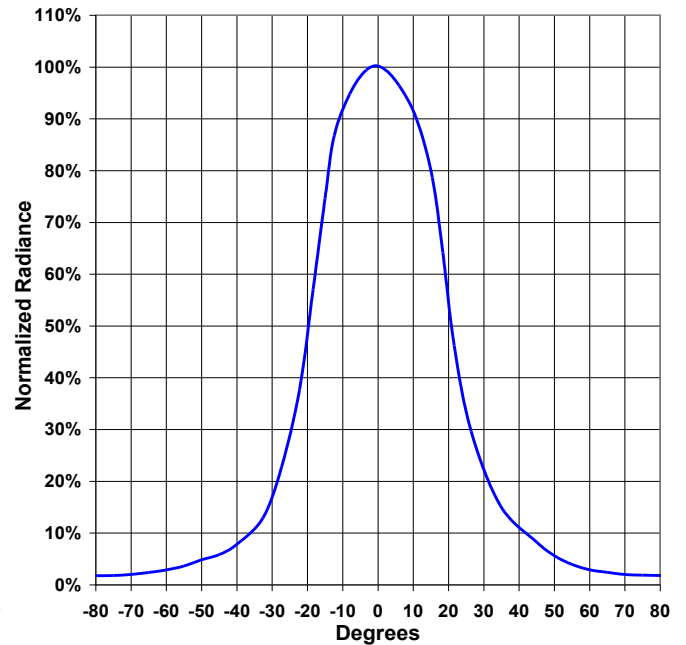

General Note

TT Electronics reserves the right to make changes in product specification without notice or liability. All information is subject to TT Electronics' own data and is considered accurate at time of going to print.

OPTEK Technology, Inc.
1645 Wallace Drive, Carrollton, TX 75006 | Ph: +1 972 323 2200
www.optekinc.com | www.ttelectronics.com