

NHD-0220CW-AY3

Character OLED Display Module

NHD-	Newhaven Display
0220-	2 lines x 20 characters
CW-	Character OLED Module
A-	Model
Y-	Yellow
3-	2.4V~5.5V Supply Voltage

Newhaven Display International, Inc.

2661 Galvin Ct.

Elgin IL, 60124

Ph: 847-844-8795

Fax: 847-844-8796

www.newhavendisplay.com

nhtech@newhavendisplay.com

nhsales@newhavendisplay.com

Document Revision History

Revision	Date	Description	Changed by
0	12/15/2014	Initial Release	AK
1	4/6/2015	Pin Description, Electrical Characteristics Updated	PB

Functions and Features

- 2 lines x 20 characters
- Built-in LCD comparable controller
- 4/8-bit Parallel, SPI, or I²C MPU interface
- 2.8V or 5.0V operation
- RoHS compliant
- Slim design

Mechanical Drawing

Rev	Description	Date

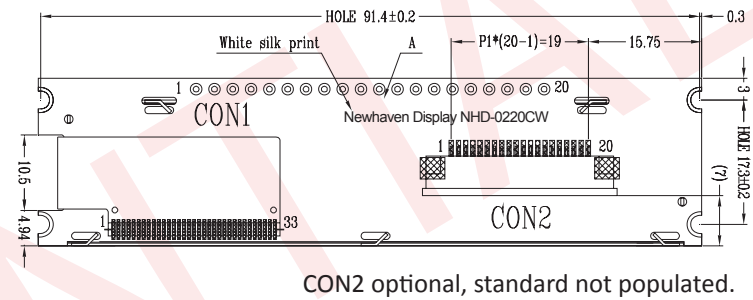
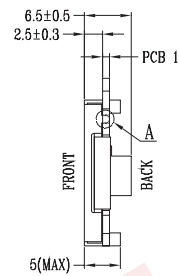
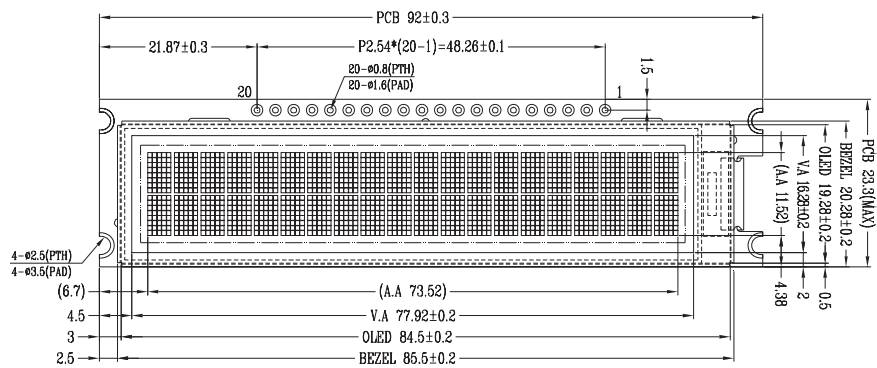

CON1 & CON2 Pin Assignment:

NO.	1	2	3	4	5	6	7	8	9	10
Symbol	VSS	VDD	REGVDD	D/C	R/W	E	D0	D1	D2	D3
NO.	11	12	13	14	15	16	17	18	19	20
Symbol	D4	D5	D6	D7	CS	RES	BS0	BS1	BS2	VSS(FrameGround)

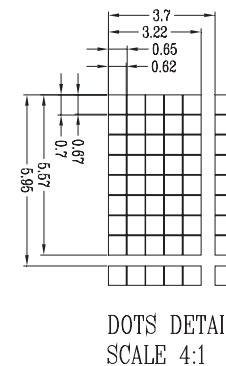
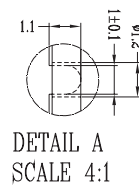

Notes:

1. Color: Yellow
2. Display format: 2 line x 20 character
3. Supply Voltage: 2.4V~5.5V
4. Interface: 4/8-bit Parallel, SPI, I²C
5. Controller: US2066
6. RoHS Compliant

	Date 10/22/14	 NEWHAVEN DISPLAY INTERNATIONAL
Gen. Tolerance ±0.3mm	Unit mm	

The drawing contained herein is the exclusive property of Newhaven Display International, Inc. and shall not be copied, reproduced, and/or disclosed in any format without permission.

Pin Description

Parallel Interface:

Pin No.	Symbol	External Connection	Function Description
1	VSS	Power Supply	Ground
2	VDD	Power Supply	Supply Voltage for OLED and Logic VDD=2.8V for 2.8V operation, VDD=5V for 5V operation
3	REGVDD	Power Supply	Internal 5V I/O Regulator select signal REGVDD=0V for 2.8V operation, REGVDD=5V for 5V operation
4	D/C	MPU	Data/Command select signal. D/C=0: Command, D/C=1: Data
5	R/W	MPU	Read/Write select signal, R/W=1: Read R/W=0: Write
6	E	MPU	Operation Enable signal. Falling edge triggered.
7-10	DB0 – DB3	MPU	Four low order bi-directional three-state data bus lines. These four are not used during 4-bit operation.
11-14	DB4 – DB7	MPU	Four high order bi-directional three-state data bus lines.
15	/CS	MPU	Active LOW Chip Select signal
16	/RES	MPU	Active LOW Reset signal
17-19	BS0 – BS2	MPU	MPU interface select signal
20	VSS	Power Supply	Ground

Serial Interface:

Pin No.	Symbol	External Connection	Function Description
1	VSS	Power Supply	Ground
2	VDD	Power Supply	Supply Voltage for OLED and Logic VDD=2.8V for 2.8V operation, VDD=5V for 5V operation
3	REGVDD	Power Supply	Internal 5V I/O Regulator select signal REGVDD=0V for 2.8V operation, REGVDD=5V for 5V operation
4-6	NC	-	No Connect. Tie to Ground
7	SCLK	MPU	Serial Clock signal
8	SDI	MPU	Serial Data Input signal
9	SDO	MPU	Serial Data Output signal
10-14	NC	-	No Connect. Tie to Ground
15	/CS	MPU	Active LOW Chip Select signal
16	/RES	MPU	Active LOW Reset signal
17-19	BS0 – BS2	MPU	MPU interface select signal
20	VSS	Power Supply	Ground

I²C Interface:

Pin No.	Symbol	External Connection	Function Description
1	VSS	Power Supply	Ground
2	VDD	Power Supply	Supply Voltage for OLED and Logic VDD=2.8V for 2.8V operation, VDD=5V for 5V operation
3	REGVDD	Power Supply	Internal 5V I/O Regulator select signal REGVDD=0V for 2.8V operation, REGVDD=5V for 5V operation
4	SA0	MPU	Slave Address select signal
5-6	NC	-	No Connect. Tie to Ground
7	SCL	MPU	Serial Clock signal
8	SDA _{IN}	MPU	Serial Data Input.
9	SDA _{OUT}	MPU	Serial Data Output. Tie together with SDA _{IN} (pin 8)
10-15	NC	-	No Connect. Tie to Ground
16	/RES	MPU	Active LOW Reset signal
17-19	BS0 – BS2	MPU	MPU interface select signal
20	VSS	Power Supply	Ground

MPU Interface Pin Selections

Pin Name	4-bit Parallel 6800 interface	4-bit Parallel 8080 interface	8-bit Parallel 6800 interface	8-bit Parallel 8080 interface	Serial Interface	I ² C Interface
BS0	1	1	0	0	0	0
BS1	0	1	0	1	0	1
BS2	1	1	1	1	0	0

MPU Interface Pin Assignment Summary

Bus Interface	Data/Command Interface								Control Signals				
	D7	D6	D5	D4	D3	D2	D1	D0	E	R/W	/CS	D/C	/RES
4-bit 6800	D[7:4]				Tie LOW				E	R/W	/CS	D/C	/RES
4-bit 8080	D[7:4]				Tie LOW				/RD	/WR	/CS	D/C	/RES
8-bit 6800	D[7:0]								E	R/W	/CS	D/C	/RES
8-bit 8080	D[7:0]								/RD	/WR	/CS	D/C	/RES
SPI	Tie LOW					SDO	SDI	SCLK	Tie LOW		/CS	Tie LOW	/RES
I ² C	Tie LOW					SDA _{OUT}	SDA _{IN}	SCL	Tie LOW			SA0	/RES

Electrical Characteristics

Item	Symbol	Condition	Min.	Typ.	Max.	Unit
Operating Temperature Range	Top	Absolute Max	-40	-	+85	°C
Storage Temperature Range	Tst	Absolute Max	-40	-	+90	°C
Supply Voltage for logic	VDD		2.4	2.8	5.5	V
Supply Voltage for I/O Regulator	REGVDD	VDD = 5V	4.4	5.0	5.5	V
Supply Current	IDD		-	70	135	mA
Sleep Mode Current	IDD _{SLEEP}		-	2	5	mA
"H" Level input	Vih		0.8*VDD	-	-	V
"L" Level input	Vil		-	-	0.2*VDD	V
"H" Level output	Voh		0.9*VDD	-	-	V
"L" Level output	Vol		-	-	0.1*VDD	V

Optical Characteristics

Item	Symbol	Condition	Min.	Typ.	Max.	Unit
Viewing Angle – Top		Cr ≥ 10,000:1	80	-	-	°
Viewing Angle – Bottom			80	-	-	°
Viewing Angle – Left			80	-	-	°
Viewing Angle – Right			80	-	-	°
Contrast Ratio	Cr		10,000:1	-	-	-
Response Time (rise)	Tr	-	-	10	-	us
Response Time (fall)	Tf	-	-	10	-	us
Brightness		50% checkerboard	120	150	-	cd/m ²
Lifetime		Ta=25°C, 50% checkerboard	80,000	-	-	Hrs

Note: Lifetime at typical temperature is based on accelerated high-temperature operation. Lifetime is tested at average 50% pixels on and is rated as Hours until **Half-Brightness**. The Display OFF command can be used to extend the lifetime of the display.

Luminance of active pixels will degrade faster than inactive pixels. Residual (burn-in) images may occur. To avoid this, every pixel should be illuminated uniformly.

Controller Information

Built-in US2066 controller.

Please download specification at http://www.newhavendisplay.com/app_notes/US2066.pdf

DDRAM Address

1	2	3	4	5	6	7	8	9	10	11	12	13	14	15	16	17	18	19	20
00	01	02	03	04	05	06	07	08	09	0A	0B	0C	0D	0E	0F	10	11	12	13
40	41	42	43	44	45	46	47	48	49	4A	4B	4C	4D	4E	4F	50	51	52	53

Table of Commands

1. Fundamental Command Set															
Command	IS	RE	SD	Instruction Code										Description	
				D/C#	R/W# (WR#)	D7	D6	D5	D4	D3	D2	D1	D0		
Clear Display	X	X	0	0	0	0	0	0	0	0	0	0	0	1	Write "20H" to DDRAM and set DDRAM address to "00H" from AC.
Return Home	X	0	0	0	0	0	0	0	0	0	0	0	1	*	Set DDRAM address to "00H" from AC and return cursor to its original position if shifted. The contents of DDRAM are not changed.
Entry Mode Set	X	0	0	0	0	0	0	0	0	0	0	1	I/D	S	Assign cursor / blink moving direction with DDRAM address. I/D = "1": cursor/ blink moves to right and DDRAM address is increased by 1 (POR) I/D = "0": cursor/ blink moves to left and DDRAM address is decreased by 1 Assign display shift with DDRAM address. S = "1": make display shift of the enabled lines by the DS4 to DS1 bits in the shift enable instruction. Left/ right direction depends on I/D bit selection. S = "0": display shift disable (POR)
	X	1	0	0	0	0	0	0	0	0	0	1	BDC	BDS	Common bi-direction function. BDC = "0": COM31 -> COM0 BDC = "1": COM0 -> COM31 Segment bi-direction function. BDS = "0": SEG99 -> SEG0, BDS = "1": SEG0 -> SEG99
Display ON / OFF Control	X	0	0	0	0	0	0	0	0	0	1	D	C	B	Set display/cursor/blink ON/OFF D = "1": display ON, D = "0": display OFF (POR), C = "1": cursor ON, C = "0": cursor OFF (POR), B = "1": blink ON, B = "0": blink OFF (POR).
Extended Function Set	X	1	0	0	0	0	0	0	0	0	1	FW	B/W	NW	Assign font width, black/white inverting of cursor, and 4-line display mode control bit. FW = "1": 6-dot font width, FW = "0": 5-dot font width (POR), B/W = "1": black/white inverting of cursor enable, B/W = "0": black/white inverting of cursor

1. Fundamental Command Set															
Command	IS	RE	SD	Instruction Code										Description	
				D/C#	R/W# (WR#)	D7	D6	D5	D4	D3	D2	D1	D0		
															disable (POR) NW = "1": 3-line or 4-line display mode NW = "0": 1-line or 2-line display mode
Cursor or Display Shift	0	0	0	0	0	0	0	0	0	1	S/C	R/L	*	*	Set cursor moving and display shift control bit, and the direction, without changing DDRAM data. S/C = "1": display shift, S/C = "0": cursor shift, R/L = "1": shift to right, R/L = "0": shift to left
Double Height (4-line) / Display-dot shift	0	1	0	0	0	0	0	0	0	1	UD2	UD1	*	DH'	UD2~1: Assign different doubt height format (POR=11b) Refer to Table 7-2 for details DH' = "1": display shift enable DH' = "0": dot scroll enable (POR)
Shift Enable	1	1	0	0	0	0	0	0	0	1	DS4	DS3	DS2	DS1	DS[4:1]=1111b (POR) when DH' = 1b Determine the line for display shift. DS1 = "1/0": 1 st line display shift enable/disable DS2 = "1/0": 2 nd line display shift enable/disable DS3 = "1/0": 3 rd line display shift enable/disable DS4 = "1/0": 4 th line display shift enable/disable.
Scroll Enable	1	1	0	0	0	0	0	0	0	1	HS4	HS3	HS2	HS1	HS[4:1]=1111b (POR) when DH' = 0b Determine the line for horizontal smooth scroll. HS1 = "1/0": 1 st line dot scroll enable/disable HS2 = "1/0": 2 nd line dot scroll enable/disable HS3 = "1/0": 3 rd line dot scroll enable/disable HS4 = "1/0": 4 th line dot scroll enable/disable.
Function Set	X	0	0	0	0	0	0	0	1	*	N	DH	RE (0)	IS	Numbers of display line, N when N = "1": 2-line (NW=0b) / 4-line (NW=1b), when N = "0": 1-line (NW=0b) / 3-line (NW=1b) DH = "1/0": Double height font control for 2-line mode enable/ disable (POR=0) Extension register, RE ("0") Extension register, IS

1. Fundamental Command Set														
Command	IS	RE	SD	Instruction Code										Description
				D/C#	R/W# (WR#)	D7	D6	D5	D4	D3	D2	D1	D0	
	X	1	0	0	0	0	0	1	*	N	BE	RE (1)	REV	CGRAM blink enable BE = 1b: CGRAM blink enable BE = 0b: CGRAM blink disable (POR) Extension register, RE ("1") Reverse bit REV = "1": reverse display, REV = "0": normal display (POR)
Set CGRAM address	0	0	0	0	0	0	1	AC5	AC4	AC3	AC2	AC1	AC0	Set CGRAM address in address counter. (POR=00 0000)
Set DDRAM Address	X	0	0	0	0	1	AC6	AC5	AC4	AC3	AC2	AC1	AC0	Set DDRAM address in address counter. (POR=000 0000)
Set Scroll Quantity	X	1	0	0	0	1	*	SQ5	SQ4	SQ3	SQ2	SQ1	SQ0	Set the quantity of horizontal dot scroll. (POR=00 0000) Valid up to SQ[5:0] = 110000b
Read Busy Flag and Address/ Part ID	X	X	0	0	1	BF	AC6 / ID6	AC5 / ID5	AC4 / ID4	AC3 / ID3	AC2 / ID2	AC1 / ID1	AC0 / ID0	Can be known whether during internal operation or not by reading BF. The contents of address counter or the part ID can also be read. When it is read the first time, the address counter can be read. When it is read the second time, the part ID can be read. BF = "1": busy state BF = "0": ready state
Write data	X	X	0	1	0	D7	D6	D5	D4	D3	D2	D1	D0	Write data into internal RAM (DDRAM / CGRAM).
Read data	X	X	0	1	1	D7	D6	D5	D4	D3	D2	D1	D0	Read data from internal RAM (DDRAM / CGRAM).

2. Extended Command Set																																								
Command	IS	RE	SD	Instruction Code										Description																										
				D/C#	R/W# (WR#)	Hex	D7	D6	D5	D4	D3	D2	D1		D0																									
Function Selection A	X	1	0	0	0	71	0	1	1	1	0	0	0	1	A[7:0] = 00h, Disable internal V _{DD} regulator at 5V I/O application mode A[7:0] = 5Ch, Enable internal V _{DD} regulator at 5V I/O application mode (POR)																									
	X	1	0	1	0	A[7:0]	A ₇	A ₆	A ₅	A ₄	A ₃	A ₂	A ₁	A ₀																										
Function Selection B	X	1	0	0	0	72	0	1	1	1	0	0	1	0	OPR[1:0]: Select the character no. of character generator <table border="1" style="margin-left: 20px;"> <thead> <tr> <th>OPR[1:0]</th> <th>CGROM</th> <th>CGRAM</th> </tr> </thead> <tbody> <tr> <td>00b</td> <td>240</td> <td>8</td> </tr> <tr> <td>01b</td> <td>248</td> <td>8</td> </tr> <tr> <td>10b</td> <td>250</td> <td>6</td> </tr> <tr> <td>11b</td> <td>256</td> <td>0</td> </tr> </tbody> </table> ROM[1:0]: Select character ROM <table border="1" style="margin-left: 20px;"> <thead> <tr> <th>RO[1:0]</th> <th>ROM</th> </tr> </thead> <tbody> <tr> <td>00b</td> <td>A</td> </tr> <tr> <td>01b</td> <td>B</td> </tr> <tr> <td>10b</td> <td>C</td> </tr> <tr> <td>11b</td> <td>Invalid</td> </tr> </tbody> </table>	OPR[1:0]	CGROM	CGRAM	00b	240	8	01b	248	8	10b	250	6	11b	256	0	RO[1:0]	ROM	00b	A	01b	B	10b	C	11b	Invalid
	OPR[1:0]	CGROM	CGRAM																																					
00b	240	8																																						
01b	248	8																																						
10b	250	6																																						
11b	256	0																																						
RO[1:0]	ROM																																							
00b	A																																							
01b	B																																							
10b	C																																							
11b	Invalid																																							
X	1	0	1	0	0		*	*	*	*	ROM	ROM	OPR	OPR																										
OLED Characterization	X	1	X	0	0	78 / 79	0	1	1	1	1	0	0	SD	Extension register, SD SD = 0b: OLED command set is disabled (POR) SD = 1b: OLED command set is enabled Details refer to Table 6-3.																									
	X	1	X	1	0																																			

3. OLED Command Set																																	
Command	IS	RE	SD	Instruction Code										Description																			
				D/C#	R/W# (WR#)	Hex	D7	D6	D5	D4	D3	D2	D1		D0																		
Set Contrast Control	X	1	1	0	0	81	1	0	0	0	0	0	0	1	Double byte command to select 1 out of 256 contrast steps. Contrast increases as the value increases. (POR = 7Fh)																		
Set Display Clock Divide Ratio/Oscillator Frequency	X	1	1	0	0	D5	1	1	0	1	0	1	0	1	A[3:0]: Define the divide ratio (D) of the display clocks (DCLK): divide ratio = A[3:0] + 1 (POR=0000b) A[7:4]: Set the Oscillator Frequency, F _{OSC} . Oscillator Frequency increases with the value of A[7:4] and vice versa. (POR=0111b) Range:0000b~1111b Frequency increases as setting value increases.																		
Set Phase Length	X	1	1	0	0	D9	1	1	0	1	1	0	0	1	A[3:0]: Phase 1 period of up to 32 DCLK; clock 0 is an valid entry with 2 DCLK (POR=1000b) A[7:4]: Phase 2 period of up to 15 DCLK; clock 0 is invalid entry (POR=0111b)																		
Set SEG Pins Hardware Configuration	X	1	1	0	0	DA	1	1	0	1	1	0	1	0	A[4]=0b, Sequential SEG pin configuration A[4]=1b (POR), Alternative (odd/even) SEG pin configuration A[5]=0b (POR), Disable SEG Left/Right remap A[5]=1b, Enable SEG Left/Right remap Refer to Table 6-4 for details																		
Set V _{COMH} Deselect Level	X	1	1	0	0	DB	1	1	0	1	1	0	1	1	<table border="1"> <thead> <tr> <th>A[6:4]</th> <th>Hex code</th> <th>V_{COMH} deselect level</th> </tr> </thead> <tbody> <tr> <td>000b</td> <td>00h</td> <td>~ 0.65 x V_{CC}</td> </tr> <tr> <td>001b</td> <td>10h</td> <td>~ 0.71 x V_{CC}</td> </tr> <tr> <td>010b</td> <td>20h</td> <td>~ 0.77 x V_{CC} (POR)</td> </tr> <tr> <td>011b</td> <td>30h</td> <td>~ 0.83 x V_{CC}</td> </tr> <tr> <td>100b</td> <td>40h</td> <td>1 x V_{CC}</td> </tr> </tbody> </table>	A[6:4]	Hex code	V _{COMH} deselect level	000b	00h	~ 0.65 x V _{CC}	001b	10h	~ 0.71 x V _{CC}	010b	20h	~ 0.77 x V _{CC} (POR)	011b	30h	~ 0.83 x V _{CC}	100b	40h	1 x V _{CC}
A[6:4]	Hex code	V _{COMH} deselect level																															
000b	00h	~ 0.65 x V _{CC}																															
001b	10h	~ 0.71 x V _{CC}																															
010b	20h	~ 0.77 x V _{CC} (POR)																															
011b	30h	~ 0.83 x V _{CC}																															
100b	40h	1 x V _{CC}																															

3. OLED Command Set																													
Command	IS	RE	SD	Instruction Code										Description															
				D/C#	R/W# (WR#)	Hex	D7	D6	D5	D4	D3	D2	D1		D0														
Function Selection C	X	1	1	0	0	DC	1	1	0	1	1	1	0	0	Set VSL & GPIO Set VSL: A[7] = 0b: Internal VSL (POR) A[7] = 1b: Enable external VSL Set GPIO: A[1:0]= 00b represents GPIO pin HiZ, input disabled (always read as low) A[1:0]= 01b represents GPIO pin HiZ, input enabled A[1:0]= 10b represents GPIO pin output Low (RESET) A[1:0]= 11b represents GPIO pin output High														
	X	1	1	0	0	A[7:0]	A ₇	0	0	0	0	0	A ₁	A ₀															
Set Fade Out and Blinking	X	1	1	0	0	23	0	0	1	0	0	0	1	1	A[5:4] = 00b Disable Fade Out / Blinking Mode[RESET] A[5:4] = 10b Enable Fade Out mode. Once Fade Mode is enabled, contrast decrease gradually to all pixels OFF. Output follows RAM content when Fade mode is disabled. A[5:4] = 11b Enable Blinking mode. Once Blinking Mode is enabled, contrast decrease gradually to all pixels OFF and then contrast increase gradually to normal display. This process loop continuously until the Blinking mode is disabled. A[3:0] : Set time interval for each fade step <table border="1" style="margin-left: auto; margin-right: auto;"> <thead> <tr> <th>A[3:0]</th> <th>Time interval for each fade step</th> </tr> </thead> <tbody> <tr> <td>0000b</td> <td>8 Frames</td> </tr> <tr> <td>0001b</td> <td>16 Frames</td> </tr> <tr> <td>0010b</td> <td>24 Frames</td> </tr> <tr> <td>:</td> <td>:</td> </tr> <tr> <td>1110b</td> <td>120 Frames</td> </tr> <tr> <td>1111b</td> <td>128 Frames</td> </tr> </tbody> </table>	A[3:0]	Time interval for each fade step	0000b	8 Frames	0001b	16 Frames	0010b	24 Frames	:	:	1110b	120 Frames	1111b	128 Frames
	A[3:0]	Time interval for each fade step																											
0000b	8 Frames																												
0001b	16 Frames																												
0010b	24 Frames																												
:	:																												
1110b	120 Frames																												
1111b	128 Frames																												
X	1	1	0	0	A[5:0]	*	*	A ₅	A ₄	A ₃	A ₂	A ₁	A ₀																

Timing Characteristics

6800-Series Parallel Interface:

Symbol	Parameter	Min	Typ	Max	Unit
t_{cycle}	Clock Cycle Time (write cycle)	400	-	-	ns
t_{AS}	Address Setup Time	13	-	-	ns
t_{AH}	Address Hold Time	17	-	-	ns
t_{CS}	Chip Select Time	0	-	-	ns
t_{CH}	Chip Select Hold Time	0	-	-	ns
t_{DSW}	Write Data Setup Time	35	-	-	ns
t_{DHW}	Write Data Hold Time	18	-	-	ns
t_{DHR}	Read Data Hold Time	13	-	-	ns
t_{OH}	Output Disable Time	10	-	90	ns
t_{ACC}	Access Time (RAM)	-	-	125	ns
	Access Time (command)	-	-	125	ns
PW_{CSL}	Chip Select Low Pulse Width (read RAM)	250	-	-	ns
	Chip Select Low Pulse Width (read Command)	250	-	-	ns
	Chip Select Low Pulse Width (write)	50	-	-	ns
PW_{CSH}	Chip Select High Pulse Width (read)	155	-	-	ns
	Chip Select High Pulse Width (write)	55	-	-	ns
t_R	Rise Time	-	-	15	ns
t_F	Fall Time	-	-	15	ns

Condition 1: /CS low pulse width > E high pulse width



Condition 2: /CS low pulse width < E high pulse width



8080-Series Parallel Interface:

Symbol	Parameter	Min	Typ	Max	Unit
t_{cycle}	Clock Cycle Time (write cycle)	400	-	-	ns
t_{AS}	Address Setup Time	13	-	-	ns
t_{AH}	Address Hold Time	17	-	-	ns
t_{CS}	Chip Select Time	0	-	-	ns
t_{CSH}	Chip select hold time to read signal	0	-	-	ns
t_{CSF}	Chip select hold time	0	-	-	ns
t_{DSW}	Write Data Setup Time	35	-	-	ns
t_{DHW}	Write Data Hold Time	18	-	-	ns
t_{DHR}	Read Data Hold Time	13	-	-	ns
t_{OH}	Output Disable Time	10	-	70	ns
t_{ACC}	Access Time (RAM) Access Time (command)	-	-	125	ns ns
PW_{CSL}	Chip Select Low Pulse Width (read RAM) - t_{PWLR}	250	-	-	ns
	Chip Select Low Pulse Width (read Command) - t_{PWLR}	250	-	-	ns
	Chip Select Low Pulse Width (write) - t_{PWLW}	50	-	-	ns
PW_{CSH}	Chip Select High Pulse Width (read) - t_{PWHR}	155	-	-	ns
	Chip Select High Pulse Width (write) - t_{PWHW}	55	-	-	ns
t_R	Rise Time	-	-	15	ns
t_F	Fall Time	-	-	15	ns



Serial Interface:

Symbol	Parameter	Min	Typ	Max	Unit
t_c	Serial clock cycle time	1	-	20	us
t_r, t_f	Serial clock rise/fall time	-	-	15	ns
t_w	Serial clock width (high, low)	400	-	-	ns
t_{su1}	Chip select setup time	60	-	-	ns
t_{h1}	Chip select hold time	20	-	-	ns
t_{su2}	Serial input data setup time	200	-	-	ns
t_{h2}	Serial input data hold time	TBD	-	-	ns
t_D	Serial output data delay time	-	-	TBD	ns
t_{DH}	Serial output data hold time	10	-	-	ns

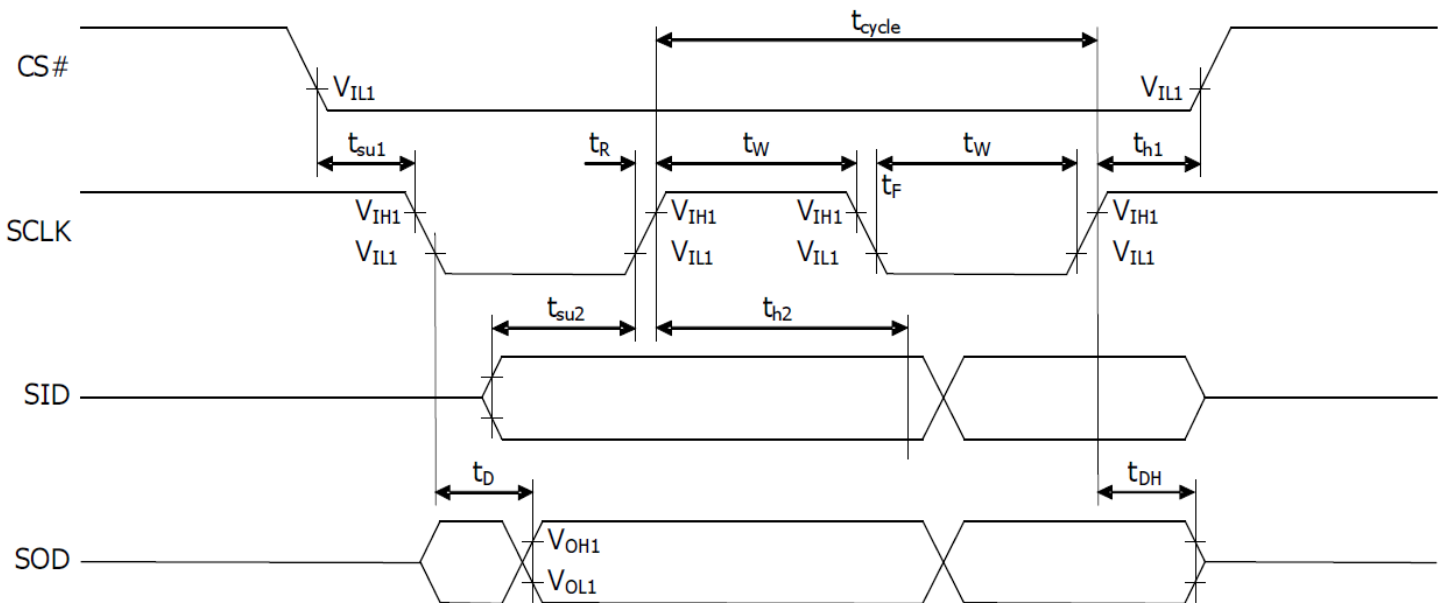

I²C Interface:

Symbol	Parameter	Min	Typ	Max	Unit
t_{cycle}	Clock Cycle Time	2.5	-	-	us
t_{HSTART}	Start condition Hold Time	0.6	-	-	us
t_{HD}	Data Hold Time (for "SDA _{OUT} " pin)	5	-	-	ns
	Data Hold Time (for "SDA _{IN} " pin)	300	-	-	ns
t_{SD}	Data Setup Time	100	-	-	ns
t_{SSTART}	Start condition Setup Time (Only relevant for a repeated Start condition)	0.6	-	-	us
t_{SSTOP}	Stop condition Setup Time	0.6	-	-	us
t_{R}	Rise Time for data and clock pin	-	-	300	ns
t_{F}	Fall Time for data and clock pin	-	-	300	ns
t_{IDLE}	Idle Time before a new transmission can start	1.3	-	-	us



Built-in Font Tables

ROM A (ROM[1:0] = [0:0])

b7-4 3D=0	0000	0001	0010	0011	0100	0101	0110	0111	1000	1001	1010	1011	1100	1101	1110	1111
0000																
0001																
0010																
0011																
0100																
0101																
0110																
0111																
1000																
1001																
1010																
1011																
1100																
1101																
1110																
1111																

ROM B (ROM[1:0] = [0:1])

17-0 25-0	0000	0001	0010	0011	0100	0101	0110	0111	1000	1001	1010	1011	1100	1101	1110	1111
0000																
0001																
0010																
0011																
0100																
0101																
0110																
0111																
1000																
1001																
1010																
1011																
1100																
1101																
1110																
1111																

ROM C (ROM[1:0] = [1:0])

7:4 3:0	0000	0001	0010	0011	0100	0101	0110	0111	1000	1001	1010	1011	1100	1101	1110	1111
0000																
0001																
0010																
0011																
0100																
0101																
0110																
0111																
1000																
1001																
1010																
1011																
1100																
1101																
1110																
1111																

Example Program Code

```
void command(char i)
{
    C_S = 0;           //chip select LOW – active
    P1 = i;           //data on port
    D_C = 0;           //data/command select LOW – command
    R_W = 0;           //read/write select LOW – write
    E = 1;             //enable HIGH
    delayms(1);        //delay
    E = 0;             //enable LOW – data latched
}
```

```
void data(char i)
{
    C_S = 0;           //chip select LOW – active
    P1 = i;           //data on port
    D_C = 1;           //data/command select HIGH – data
    R_W = 0;           //read/write select LOW – write
    E = 1;             //enable HIGH
    delayms(1);        //delay
    E = 0;             //enable LOW – data latched
}
```

```
void output()
{
    int i;
    command(0x01);     //clear display
    command(0x02);     //return home
    for(i=0;i<20;i++)
    {
        data(0x1F);    //write solid blocks
    }
    command(0xC0);     //line 2
    for(i=0;i<20;i++)
    {
        data(0x1F);    //write solid blocks
    }
}
```

```
void init()
{
    RES = 1;           //reset HIGH – inactive
    delayms(1);        //delay
    command(0x2A);     //function set (extended command set)
    command(0x71);     //function selection A
    data(0x00);        // disable internal VDD regulator (2.8V I/O). data(0x5C) = enable regulator (5V I/O)
    command(0x28);     //function set (fundamental command set)
    command(0x08);     //display off, cursor off, blink off
    command(0x2A);     //function set (extended command set)
    command(0x79);     //OLED command set enabled
}
```

```

command(0xD5); //set display clock divide ratio/oscillator frequency
command(0x70); //set display clock divide ratio/oscillator frequency
command(0x78); //OLED command set disabled
command(0x08); //extended function set (2-lines)
command(0x06); //COM SEG direction
command(0x72); //function selection B
data(0x00); //ROM CGRAM selection
command(0x2A); //function set (extended command set)
command(0x79); //OLED command set enabled
command(0xDA); //set SEG pins hardware configuration
command(0x10); //set SEG pins hardware configuration
command(0xDC); //function selection C
command(0x00); //function selection C
command(0x81); //set contrast control
command(0x7F); //set contrast control
command(0xD9); //set phase length
command(0xF1); //set phase length
command(0xDB); //set VCOMH deselect level
command(0x40); //set VCOMH deselect level
command(0x78); //OLED command set disabled
command(0x28); //function set (fundamental command set)
command(0x01); //clear display
command(0x80); //set DDRAM address to 0x00
command(0x0C); //display ON
delayms(100); //delay
}

```

```

void main(void)
{
    init();
    while(1)
    {
        output();
        delayms(2000);
    }
}

```

Precautions for using OLEDs/LCDs/LCMs

See Precautions at www.newhavendisplay.com/specs/precautions.pdf

Warranty Information and Terms & Conditions

http://www.newhavendisplay.com/index.php?main_page=terms