

### Features

- InGaAs technology
- 0.7 mm<sup>2</sup> PIN detector
- High sensitivity up to 1700 nm
- Extended VIS sensitivity
- Low dark current

### Description

Extended VIS sensitivity, low dark current InGaAs PIN photodiode with circular 0.7 mm<sup>2</sup> active area. Metal can type hermetic TO52 package with clear glass window.

### Application

- Precision photometry
- Analytical instruments
- Medical equipment
- Pulsed light detector
- Eyesafe laser light detector

### RoHS

2011/65/EU

### Absolute maximum ratings

Symbol	Parameter	Min	Max	Unit
T <sub>STG</sub>	Storage temp	-40	85	°C
T <sub>OP</sub>	Operating temp	-20	85	°C
V <sub>max</sub>	Max reverse voltage		20	V
I <sub>PEAK</sub>	Peak DC current		10	mA

### Spectral response

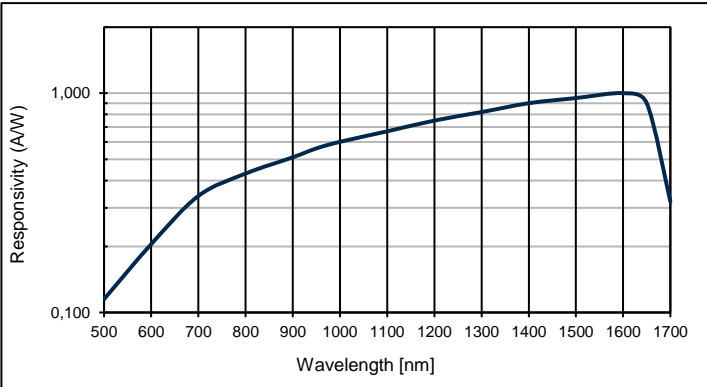

### Schematic 3001213

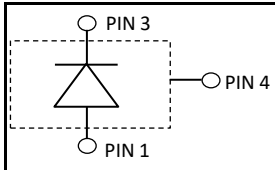

### Schematic TO52S3

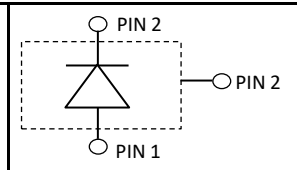

### Electro-optical characteristics @ 23°C

Symbol	Characteristic	Test Condition	Min	Typ	Max	Unit
	Active area		diameter 950			µm
	Active area		0.71			mm <sup>2</sup>
I <sub>D</sub>	Dark current	V <sub>R</sub> = 5 V		1	10	nA
C	Capacitance	V <sub>R</sub> = 0 V		140	200	pF
		V <sub>R</sub> = 5 V		70	100	pF
	Responsivity	λ = 650 nm	0.20	0.30		A/W
		λ = 850 nm	0.40	0.50		A/W
		λ = 1310 nm	0.80	0.90		A/W
		λ = 1550 nm	0.85	0.95		A/W
t <sub>R</sub>	Rise time	V <sub>R</sub> = 5 V; λ = 1550 nm; R <sub>L</sub> = 50 Ω		15		ns
	Shunt Resistance	V <sub>R</sub> = 5 mV	25	80		MΩ
	Saturation power	V <sub>R</sub> = 0 V; λ = 1550 nm; R <sub>L</sub> = 50 Ω		-8		dbm
D*	Detectivity	V <sub>R</sub> = 0 V; λ = 1550 nm; R <sub>L</sub> = 50 Ω	2.5 E12	5 E12		Jones
V <sub>BR</sub>	Breakdown voltage	I <sub>R</sub> = 2 µA	20	30		V

Quantum efficiency (23 °C)

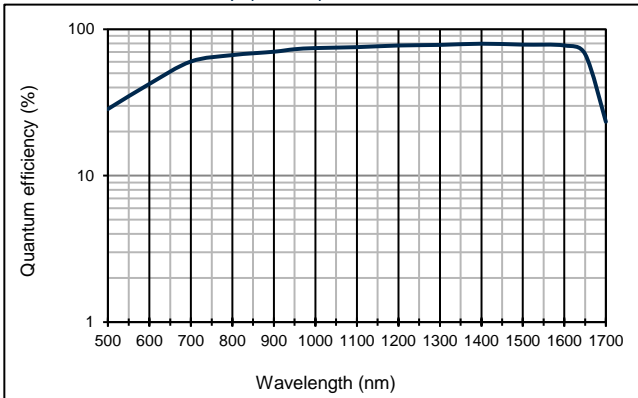

Capacitance as fct of reverse bias (23 °C)

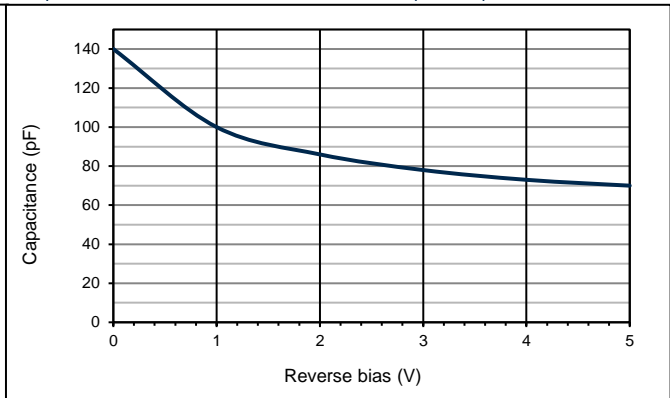

Dark current as fct of bias (23 °C)

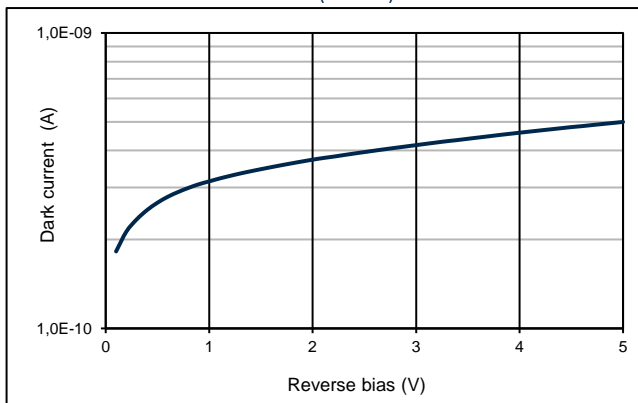

Order number 3001213, Package: TO52S1

On request: Package: TO52S3

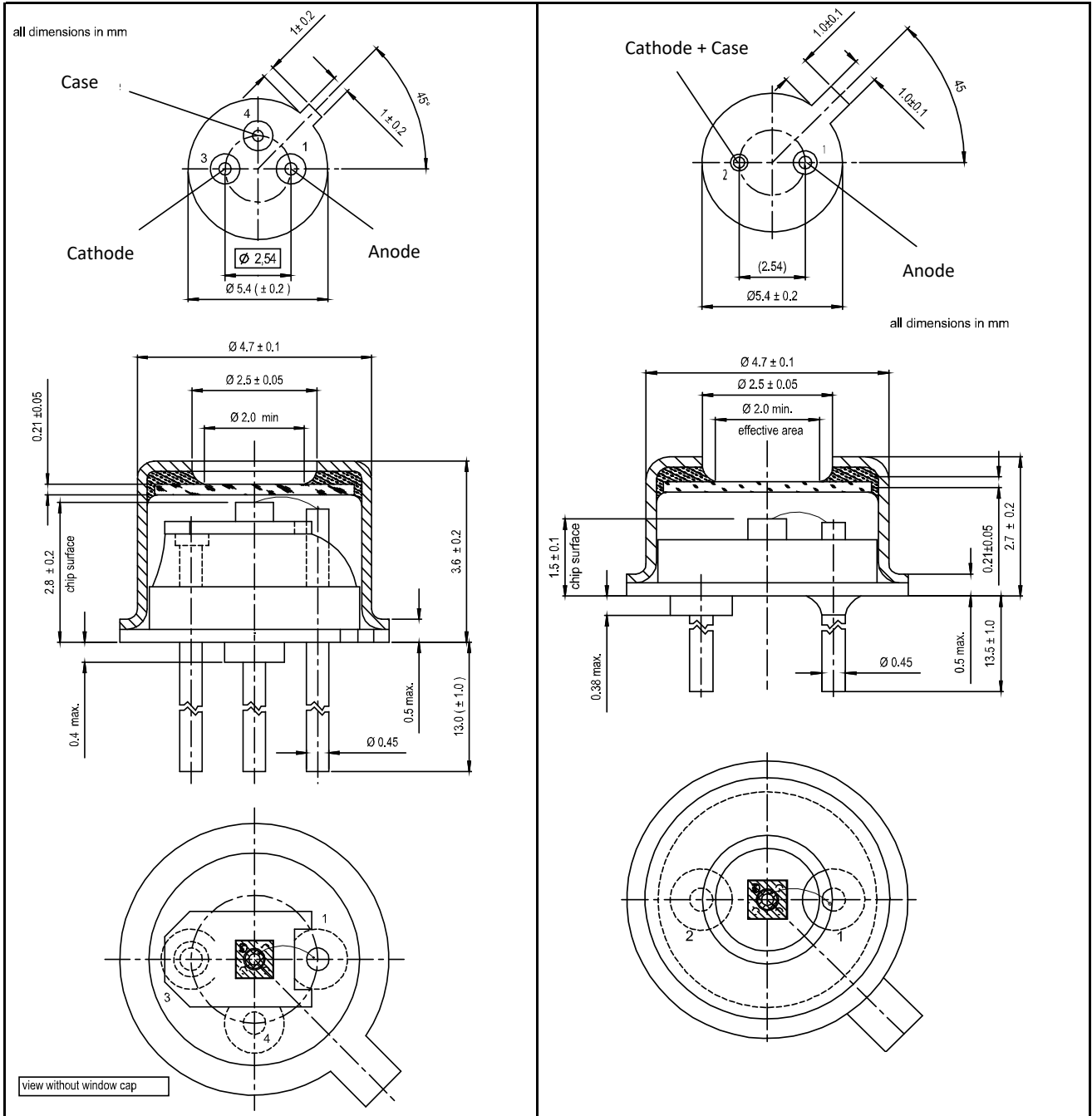

## Package dimension:

Small quantities: Foam pad, boxed (12 cm x 16.5 cm)

Disclaimer: Due to our strive for continuous improvement, specifications are subject to change within our PCN policy according to JESD46C.