

# MINIATURE RELAY

## 1 POLE—1 to 2A (FOR SIGNAL SWITCHING)

### SY SERIES

RoHS compliant



#### ■ FEATURES

- Very small size and light weight
- UL, CSA recognized
- Conforms to FCC rules and regulations part 68
  - Dielectric strength 1000 VAC between coil and contacts
  - Surge strength 1500 V
- High sensitivity
- Wide ambient temperature range (-30°C to +90°C)
- Wide operating range
- DIL pitch terminals
- Plastic sealed type
- Dial-pulse relay available (10pps, 20pps)
- RoHS compliant since date code: 0519  
Please see page 5 for more information



#### ■ ORDERING INFORMATION

[Example]       $\frac{SY}{(a)} - \frac{12}{(b)} \frac{W}{(c)} - \frac{K}{(d)}$

|     |                 |  |
|-----|-----------------|--|
| (a) | Series Name     | SY: SY Series                          |
| (b) | Nominal Voltage | Refer to the COIL DATA CHART           |
| (c) | Contact         | Nil: Single type<br>W: Bifurcated type |
| (d) | Enclosure       | K: Plastic sealed type                 |

Note: For movable and stationary contact with gold overlay type, add suffix “-OH”

## ■ COIL DATA CHART

| MODEL    |            | Nominal voltage | Coil resistance ( $\pm 10\%$ ) | Must operate voltage | Must release voltage | Nominal power |
|----------|------------|-----------------|--------------------------------|----------------------|----------------------|---------------|
| Single   | Bifurcated |                 |                                |                      |                      |               |
| SY-1.5-K | SY-1.5W-K  | 1.5 VDC         | 15 $\Omega$                    | 1.05 VDC             | 0.08 VDC             | 150 mW        |
| SY- 3 -K | SY- 3 W-K  | 3 VDC           | 60 $\Omega$                    | 2.1 VDC              | 0.15 VDC             | 150 mW        |
| SY-4.5-K | SY-4.5W-K  | 4.5 VDC         | 135 $\Omega$                   | 3.2 VDC              | 0.23 VDC             | 150 mW        |
| SY- 5 -K | SY- 5 W-K  | 5 VDC           | 167 $\Omega$                   | 3.5 VDC              | 0.25 VDC             | 150 mW        |
| SY- 6 -K | SY- 6 W-K  | 6 VDC           | 240 $\Omega$                   | 4.2 VDC              | 0.3 VDC              | 150 mW        |
| SY- 9 -K | SY- 9 W-K  | 9 VDC           | 540 $\Omega$                   | 6.3 VDC              | 0.45 VDC             | 150 mW        |
| SY-12 -K | SY-12 W-K  | 12 VDC          | 960 $\Omega$                   | 8.4 VDC              | 0.6 VDC              | 150 mW        |
| SY-18 -K | SY-18 W-K  | 18 VDC          | 1,940 $\Omega$                 | 12.6 VDC             | 0.9 VDC              | 170 mW        |
| SY-24 -K | SY-24 W-K  | 24 VDC          | 3,290 $\Omega$                 | 16.8 VDC             | 1.2 VDC              | 175 mW        |

Note : All values in the table are measured at 20°C.

## ■ SPECIFICATIONS

| Item       |                                      | SY-( ) -K (Single)   | SY-( ) W - K (Bifurcated)                |  |
|------------|--------------------------------------|--|--|--|
| Contact    | Arrangement                          | 1 form C (SPDT)  |  |  |
|            | Material                             | Gold overlay silver palladium  |  |  |
|            | Configuration                        | Single (cross bar)   | Bifurcated (cross bar)                   |  |
|            | Resistance (initial)                 | Maximum 100 mΩ (at 1 A 6 VDC)  |  |  |
|            | Rating (resistive)                   | 0.5 A 120 VAC or 1 A 24 VDC  |  |  |
|            | Maximum Carrying Current             | 2 A  |  |  |
|            | Maximum Switching Power              | 60 AV, 24 W  |  |  |
|            | Maximum Switching Voltage            | 120 VAC/60 VDC   |  |  |
|            | Maximum Switching Current            | 1 A  |  |  |
|            | Minimum Switching Load* <sup>1</sup> | 1 mA 1 VDC   | 0.1 mA 100 mVDC                          |  |
|            | Capacitance (at 10 MHz)              | Approximately 1.4 pF (between open contacts)<br>Approximately 5.0 pF (between coil and contacts) |  |  |
| Coil       | Nominal Power (at 20°C)              | 150 to 175 mW  |  |  |
|            | Operate Power (at 20°C)              | 75 to 86 mW  |  |  |
|            | Operating Temperature                | -30°C to +90°C (no frost)/18 V coil: +85°C, 24 V coil: +80°C                                     |  |  |
| Time Value | Operate (at nominal voltage)         | Maximum 5 ms   |  |  |
|            | Release (at nominal voltage)         | Maximum 2 ms   |  |  |
| Life       | Mechanical                           | 5 × 10 <sup>6</sup> operations minimum   |  |  |
|            | Electrical (at contact rating)       | 1 × 10 <sup>5</sup> operations minimum   |  |  |
| Other      | Vibration                            | Misoperation   | 10 to 55 Hz (double amplitude of 1.5 mm) |  |
|            |                                      | Resistance   | Endurance                                | 10 to 55 Hz (double amplitude of 1.5 mm) |
|            | Shock                                | Misoperation   | 300 m/s <sup>2</sup> (11 ±1 ms)          |  |
|            |                                      | Resistance   | Endurance                                | 1,000 m/s <sup>2</sup> (6 ±1 ms)         |
|            | Weight                               | Approximately 1.7 g  |  |  |

\*<sup>1</sup> Minimum switching loads mentioned above are reference values. Please perform the confirmation test with the actual load before production since reference values may vary according to switching frequencies, environmental conditions and expected reliability levels.

## ■ INSULATION

| Item                 |                   | Single   | Bifurcated                |
|----------------------|-------------------|--|---------------------------|
| Resistance (initial) |                   | Minimum 1,000 MΩ (500VDC)                      | Minimum 1,000 MΩ (250VDC) |
| Dielectric Strength  | open contacts     | 400 VAC 1 min.                                 | 300 VAC 1 min.            |
|                      | coil and contacts | 1,000 VAC 1 min.                               |                           |
| Surge Voltage        |                   | 1500V (coil-contact) (10/160 μs standard wave) |                           |

## SAFETY STANDARD AND FILE NUMBERS

| Type | Compliance               | Contact rating  |
|------|--------------------------|---|
| UL   | UL 508, 873<br>E 45026   | Flammability: UL 94-V0 (plastics)<br>[SJ-( ) A01]<br>1A, 265VAC (resistive)<br>[SJ-( ) D01] |
| CSA  | C22.2 No. 14<br>LR 35579 | 1A, 30VDC (resistive)   |

## CHARACTERISTIC DATA

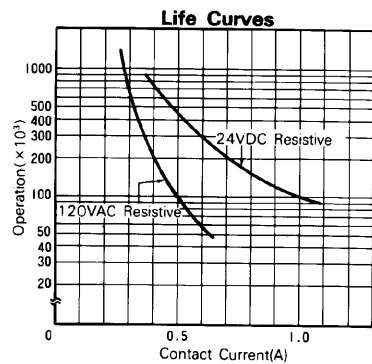
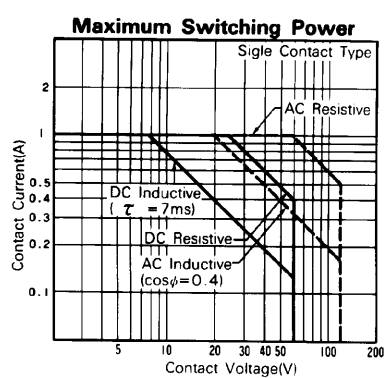
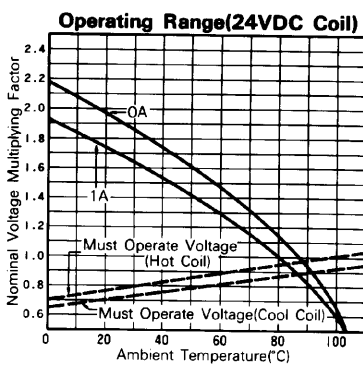
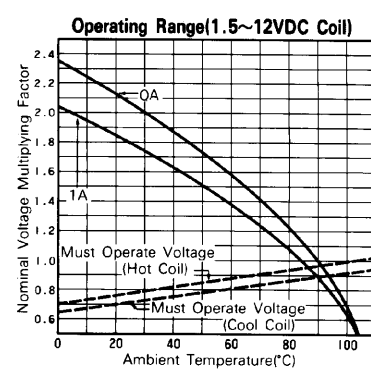
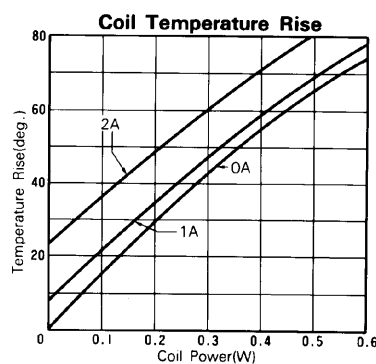

## REFERENCE DATA

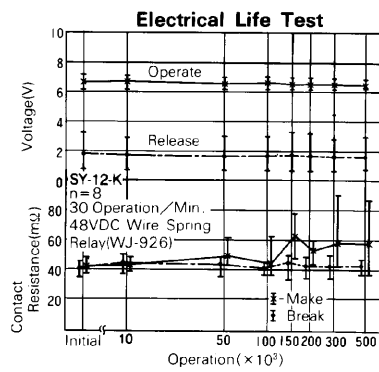
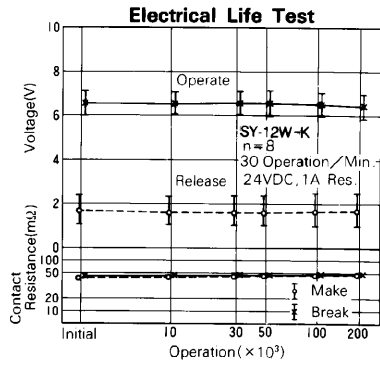
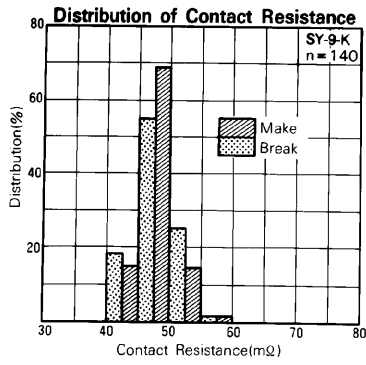
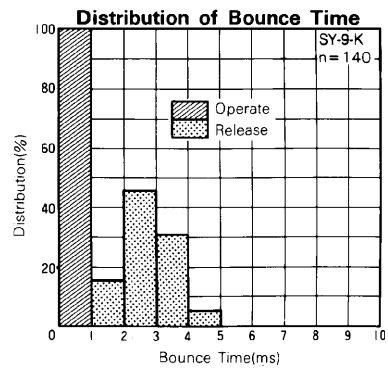
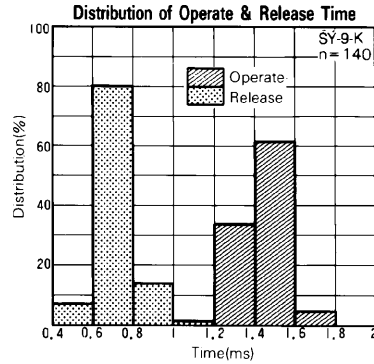

## DIMENSIONS

### Dimensions



### Schematics (Bottom View)



### PC board mounting hole layout (Bottom View)

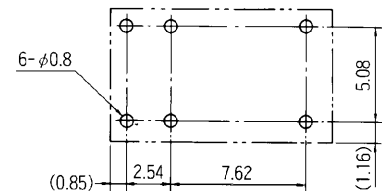

Unit: mm

## RoHS Compliance and Lead Free Relay Information

### 1. General Information

- Relays produced after the specific date code that is indicated on each data sheet are lead-free now. Most of our signal and power relays are lead-free. Please refer to Lead-Free Status Info. (<http://www.fujitsu.com/us/downloads/MICRO/fcai/relays/lead-free-letter.pdf>)
- Lead free solder paste currently used in relays is Sn-3.0Ag-0.5Cu.
- All signal and most power relays also comply with RoHS. Please refer to individual data sheets. Relays that are RoHS compliant do not contain the 5 hazardous materials that are restricted by RoHS directive (lead, mercury, chromium IV, PBB, PBDE).
- It has been verified that using lead-free relays in leaded assembly process will not cause any problems (compatible).
- "LF" is marked on each outer and inner carton. (No marking on individual relays).
- To avoid leaded relays (for lead-free sample, etc.) please consult with area sales office.
- We will ship leaded relays as long as the leaded relay inventory exists.

Note: Cadmium was exempted from RoHS on October 21, 2005. (Amendment to Directive 2002/95/EC)

### 2. Recommended Lead Free Solder Profile

- Recommended solder paste Sn-3.0Ag-0.5Cu.

#### Reflow Solder condition

**Flow Solder condition:**

Pre-heating: maximum 120°C  
Soldering: dip within 5 sec. at  
260°C solder bath

**Solder by Soldering Iron:**

Soldering Iron  
Temperature: maximum 360°C  
Duration: maximum 3 sec.

**We highly recommend that you confirm your actual solder conditions**

### 3. Moisture Sensitivity

- Moisture Sensitivity Level standard is not applicable to electromechanical relays.

### 4. Tin Whisker

- Dipped SnAgCu solder is known as low risk tin whisker. No considerable length whisker was found by our in house test.

## Fujitsu Components International Headquarter Offices

**Japan**

Fujitsu Component Limited  
Gotanda-Chuo Building  
3-5, Higashigotanda 2-chome, Shinagawa-ku  
Tokyo 141, Japan  
Tel: (81-3) 5449-7010  
Fax: (81-3) 5449-2626  
Email: [promothq@ft.ed.fujitsu.com](mailto:promothq@ft.ed.fujitsu.com)  
Web: [www.fcl.fujitsu.com](http://www.fcl.fujitsu.com)

**North and South America**

Fujitsu Components America, Inc.  
250 E. Caribbean Drive  
Sunnyvale, CA 94089 U.S.A.  
Tel: (1-408) 745-4900  
Fax: (1-408) 745-4970  
Email: [components@us.fujitsu.com](mailto:components@us.fujitsu.com)  
Web: <http://www.fujitsu.com/us/services/edevices/components/>

**Europe**

Fujitsu Components Europe B.V.  
Diamantlaan 25  
2132 WV Hoofddorp  
Netherlands  
Tel: (31-23) 5560910  
Fax: (31-23) 5560950  
Email: [info@fceu.fujitsu.com](mailto:info@fceu.fujitsu.com)  
Web: [emea.fujitsu.com/components/](http://emea.fujitsu.com/components/)

**Asia Pacific**

Fujitsu Components Asia Ltd.  
102E Pasir Panjang Road  
#01-01 Citilink Warehouse Complex  
Singapore 118529  
Tel: (65) 6375-8560  
Fax: (65) 6273-3021  
Email: [fcal@fcal.fujitsu.com](mailto:fcal@fcal.fujitsu.com)  
Web: <http://www.fujitsu.com/sg/services/micro/components/>

©2008 Fujitsu Components America, Inc. All rights reserved. All trademarks or registered trademarks are the property of their respective owners.

Fujitsu Components America or its affiliates do not warrant that the content of datasheet is error free. In a continuing effort to improve our products Fujitsu Components America, Inc. or its affiliates reserve the right to change specifications/datasheets without prior notice.  
Rev. January 11, 2008.