

Data Sheet

PS1C

Pressure Display and Switch Device



Main Features

Displayed Value Range	-14.5 to 6000 with 27 Selectable Value Ranges
Power Supply	24 VDC
Electrical Connection	M12 Female, 4 pin Output: M12 Male, 4 Pin
Digital Output	PNP or NPN, NO/NC Programmable
Output Signal	4 - 20 mA
Degree of Protection	IP65, IP67, and IP69K
Operating Temperature	-20°C to +70°C

Description

Are you looking for an easy way to read and control pressure data when the conduit is hidden from view?

Kavlico Pressure Sensors has the answer to your needs – PS1C, the simple switch with display that can be linked to a separate pressure sensor, such as Kavlico’s PTE5000, P1E and P1A delivering a clear view of accurate pressure information even if the conduit runs in a hard to access location.

The Installation of the PS1C display and switch device is simple. It can be mounted away from the pressure sensor, using a quick-fix bracket to attach to a horizontal or vertical plane or pipe. The device can alternatively be installed directly on the pressure transmitter via the M12 connector. In addition, the body of the switch can be rotated by 360° for easy adjustment of the viewing angle.

Benefits

Easy to mount

- Flexible mounting options: remotely with an electrical jumper or directly on the pressure transmitter
- Quick fix brackets, for vertical (1) or horizontal (2) placement, or attachment to a pipe
- Rotating body

Easy to set up

- Fast and intuitive configuration of just three parameters: display range, set point, reset point
- Adjustment screws compatible with standard screwdrivers

Easy to maintain

- Display status tested at each device start up and confirmed by display light up
- Convenient replacement without interrupting the pressure in the system



1



2

Perfect fit for...



PTE5000



PTA5000





P1E



P1A

Main Characteristics

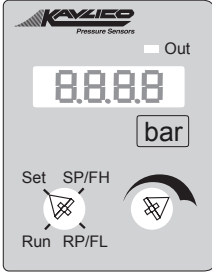
Output Configuration

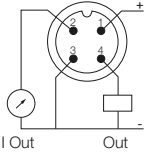
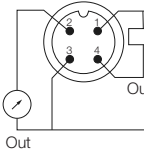
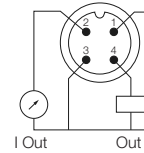
Reference	PS1C-5000-1	PS1C-5000-2	PS1C-5000-3	PS1C-5000-4	PS1C-5000-5	PS1C-5000-6
Front face caption						
Analogue output	4...20 mA	4...20 mA	4...20 mA	4...20 mA	No / Non	No / Non
Switching output	PNP	NPN	PNP	NPN	2 x PNP	2 x NPN
Switching mode	Hysteresis	Hysteresis	Window	Window	Hysteresis	Hysteresis
Connector wiring						
Power supply	c 24 Vdc SELV or PELV(*) power supply, operating range from 17 to 33 Vdc					
Current consumption	≤ 50mA					
Switching outputs	Switching capacity		≤ 200 mA with short-circuit & overload protection			
	Voltage drop		≤ 2V			
Analogue output	4...20 mA: load: ≤ 500 Ω (24V) ≤ 200 Ω (17V)					
Operating temperature range	-25 to +70 °C (-13 to +158 °F)					
Degree of protection	IP65, IP67 conforming to EN/IEC 60529					
	IP69K conforming to DIN 40050					
Overall accuracy (analogue, digital output, display)	< 1% of the selected display range					
Response time	≤ 5 ms					

(*) SELV: Safety extra low voltage /
PELV: Protected extra low voltage

Electrical equipment should be installed, operated and maintained only by qualified personnel. No responsibility is assumed by Kavlico Pressure Sensors for any consequences arising out of the use of this material.

Output Description

Switching output

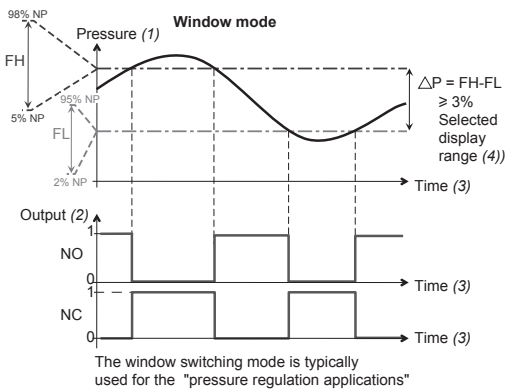
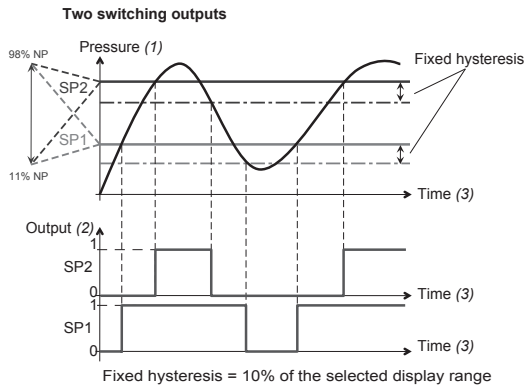

Analogue output

The 4-20mA analogue output is strictly the image of the pressure transmitter output signal

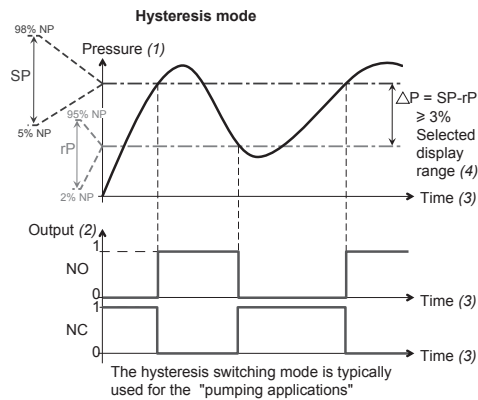
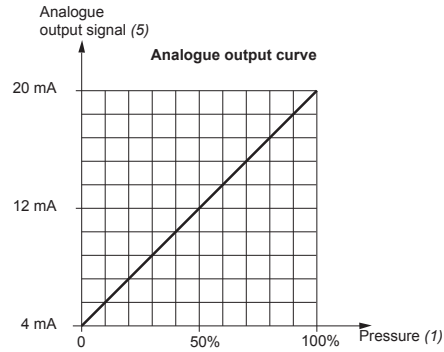

Dimensions and Tightening Torques

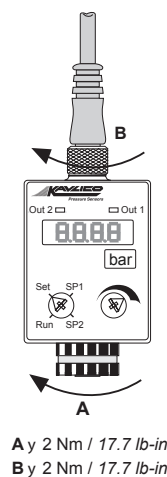
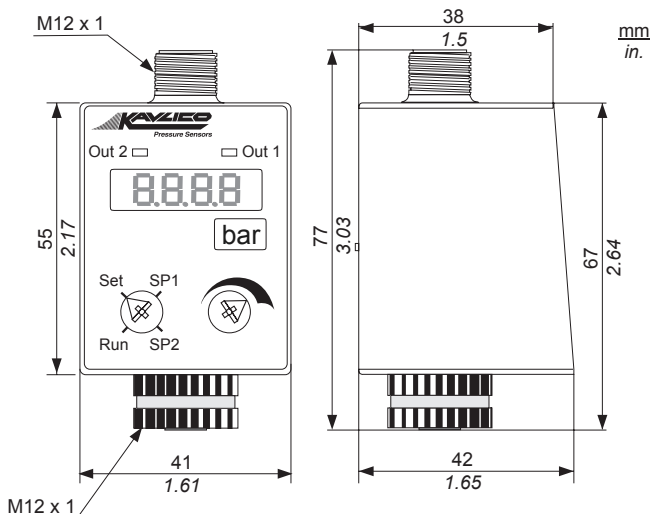

Wiring Diagram

Input M12 4-pin female connector

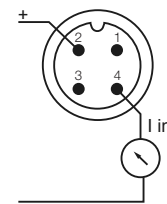

Caution



UNINTENDED EQUIPMENT OPERATION

- Only connect a 4-20mA pressure transmitter, directly or thanks to M12-M12 4-pin electrical jumper.
- Make sure the pressure transmitter pin out and analogue signal is compatible with PS1C if it is not a Kavlico one.

Failure to follow these instructions can result injury or equipment damage.

Mounting Possibility

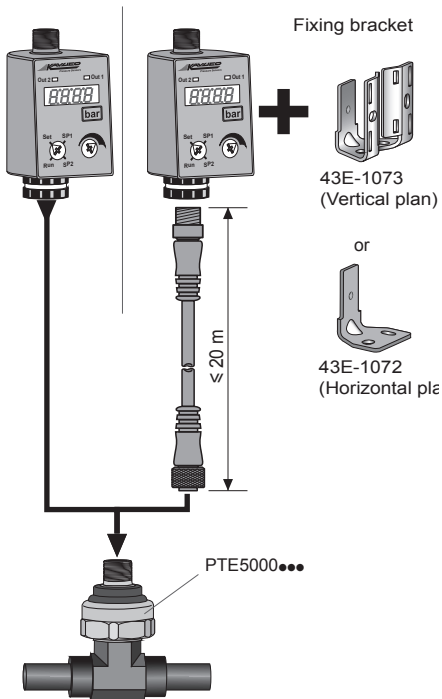

Usage Precautions

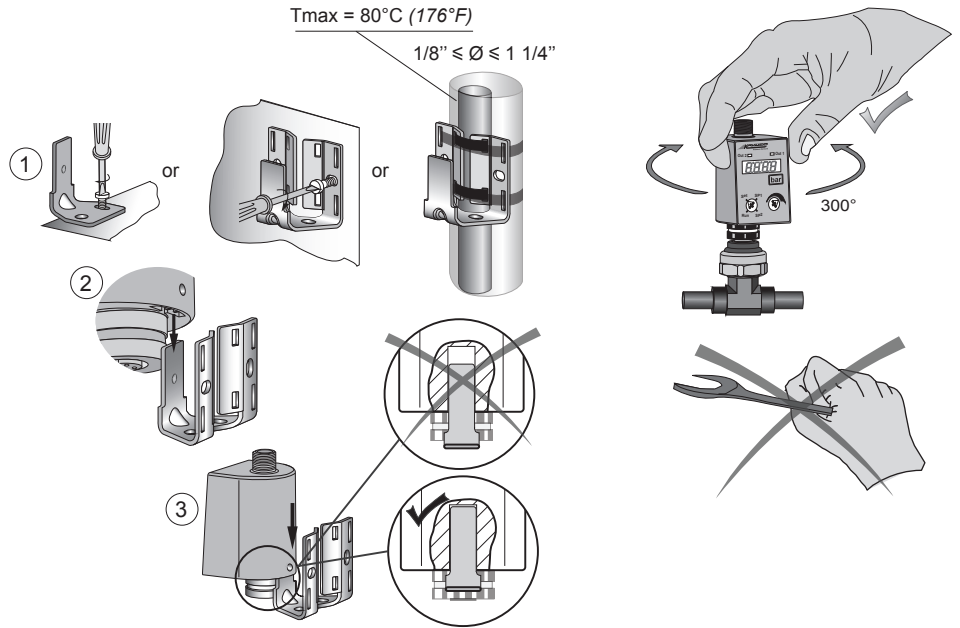

Maintenance

At each power on, all the display segments are simultaneously lit up briefly. This allows the operator to check that all segments are well operating.

Cleaning

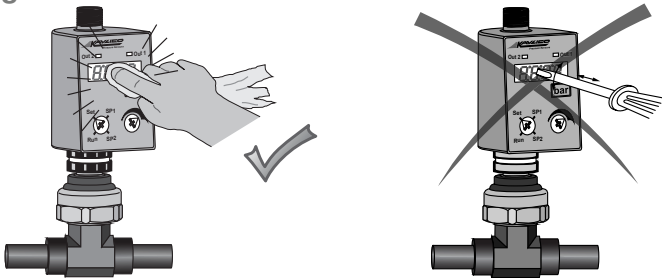

How to Order

Output 1	Output 2	Switching mode	
		Hysteresis	Windows
-	-		
4... 20 mA	PNP	PS1C-5000-1	PS1C-5000-2
4... 20 mA	NPN	PS1C-5000-3	PS1C-5000-4
PNP	PNP	PS1C-5000-5	-
NPN	NPN	PS1C-5000-6	-
Vertical surface fixing	Horizontal surface fixing	M12 Jumper cable 1.5m	
43E-1073	43E-1072	12E-1027	



Before installation and operation, ensure that the appropriate pressure sensor has been selected in terms of pressure range, design and specific measuring conditions. Non-compliance can result in serious injury and/or damage to the equipment.

Warning: The product information contained in this catalogue is given purely as information and does not constitute a representation, warranty or any form of contractual commitment. Kavlico reserve the right to modify their products without notice. It is imperative that we should be consulted over any particular use or application of our products and it is the responsibility of the buyer to establish, particularly through all the appropriate tests, that the product is suitable for the use or application. Under no circumstances will our warranty apply, nor shall we be held responsible for any application (such as any modification, addition, deletion, use in conjunction with other electrical or electronic components, circuits or assemblies, or any other unsuitable material or substance) which has not been expressly agreed by us prior to the sale of our products.



Sales Offices Worldwide

Americas

Brazil
Mexico
USA

Europe

England
France
Germany
Italy
Netherlands
Spain
Sweden
Russia

Asia Pacific

China
India
Japan
South Korea

Main Contact

Sensata Germany GmbH
Potsdamer Strasse 14,
32423 Minden
Tel: +49 571 3859-0
Fax: +49 571 3859-119
www.kavlico.com
www.sensata.com

Your local sales contact: