



Main

Range of product	OsiSense XM
Product or component type	Electronic pressure sensors
Pressure sensor type	Pressure transmitter
Pressure sensor name	XMLK
Electrical circuit type	Control circuit
Pressure sensor size	145.04 psi (10 bar)
Local display	Without
Controlled fluid	Air 32...176 °F (0...80 °C) Fresh water 32...176 °F (0...80 °C)
Fluid connection type	G 1/4A (male) conforming to DIN 3852-E
Electrical connection	1 male connector EN 175301-803-A (ex DIN43650) 4 pins
[Us] rated supply voltage	24 V DC SELV, voltage limits: 16.2...33 V
Current consumption	< 6 mA
Type of output signal	Analogue
Analogue output function	0...10 V, 3-wire
Quantity per set	Set of 1
Type of packing	Individual

Complementary

Pressure setting range	0...145.04 psi (0...10 bar)
Maximum permissible accidental pressure	290.08 psi (20 bar)
Destruction pressure	435.11 psi (30 bar)
Materials in contact with fluid	Ceramic Nitrile (NBR) Stainless steel type AISI 303
Operating position	Any position
Protection type	Load short-circuit Reverse polarity
Electromagnetic compatibility	Electrostatic discharge immunity test conforming to EN/IEC 61000-4-2 - test level 8 kV air, 6 kV contact Susceptibility to electromagnetic fields conforming to EN/IEC 61000-4-3 - test level 10 V/m (f = 80...1000 MHz) Electrical fast transient/burst immunity test conforming to EN/IEC 61000-4-4 - test level 2 kV 1.2/50 µs shock waves immunity test conforming to EN/IEC 61000-4-5 - test level 500 V 12 Ohm, 1 kV 42 Ohm Radiated RF fields conforming to EN/IEC 61000-4-6 - test level 10 V (f = 0.15...80 MHz) Immunity to magnetic fields conforming to EN/IEC 61000-4-8 - test level 30 A/m (f = 50 Hz)
[Uimp] rated impulse withstand voltage	0.5 kV
Response time on output	< 5 ms
Measurement accuracy	+/- 1 % of the measuring range
Accuracy	0.1 % of the measuring range
Drift of the sensitivity	+/- 0.04 % of measuring range/°K
Drift of the zero point	+/- 0.03 % of measuring range/°K
Repeat accuracy	+/- 1 % of the measuring range
Mechanical durability	>= 10000000 cycles
Product weight	0.24 lb(US) (0.11 kg)
Diameter	1.42 in (36 mm)
Length	2.66 in (67.5 mm)
Scale type	Fixed differential

The information provided in this documentation contains general descriptions and/or technical characteristics of the products contained herein. This documentation is not intended as a substitute for and is not to be used for determining suitability or reliability of these products for specific user applications. It is the duty of any such user or integrator to perform the appropriate and complete risk analysis, evaluation and testing of the products with respect to the relevant specific application or use thereof. Neither Schneider Electric Industries SAS nor any of its affiliates or subsidiaries shall be responsible or liable for misuse of the information contained herein.

Environment

standards	CE EN/IEC 61326-2-3
product certifications	UL 508 RCM CSA C22.2 No 14 EAC
protective treatment	TC
ambient air temperature for operation	32...176 °F (0...80 °C)
ambient air temperature for storage	-13...176 °F (-25...80 °C)
vibration resistance	20 gn (f = 9...2000 Hz) conforming to EN/IEC 60068-2-6
shock resistance	25 gn 11 ms conforming to EN/IEC 60068-2-27
IP degree of protection	IP65 conforming to EN/IEC 60529
NEMA degree of protection	NEMA 4

Offer Sustainability

Not Green Premium product	Not Green Premium product
Compliant - since 1001 - Schneider Electric declaration of conformity	Compliant - since 1001 - Schneider Electric declaration of conformity
Reference not containing SVHC above the threshold	Reference not containing SVHC above the threshold
WARNING: This product can expose you to chemicals including:	WARNING: This product can expose you to chemicals including:
Diisononyl phthalate (DINP), which is known to the State of California to cause cancer, and	Diisononyl phthalate (DINP), which is known to the State of California to cause cancer, and
Di-isodecyl phthalate (DIDP), which is known to the State of California to cause birth defects or other reproductive harm.	Di-isodecyl phthalate (DIDP), which is known to the State of California to cause birth defects or other reproductive harm.
For more information go to www.p65warnings.ca.gov	For more information go to www.p65warnings.ca.gov

Contractual warranty

Warranty period	18 months
-----------------	-----------

Dimensions

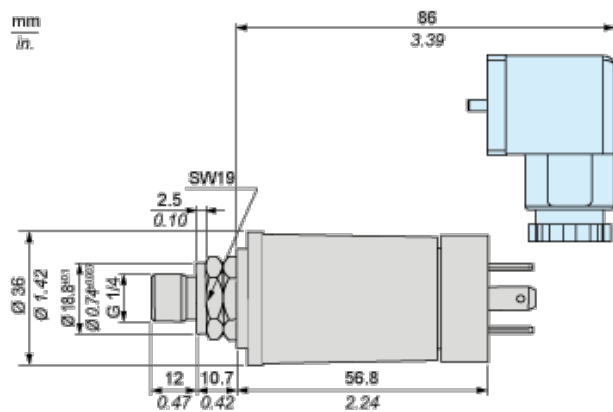

Wiring Diagram

3-Wire Technique (0-10 V)

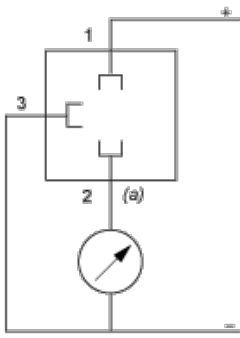

(a) V out

Output Curves

