

THESE DRAWINGS ARE THE PROPERTY OF QUALTEK ELECTRONICS AND NOT TO BE REPRODUCED FOR OR COMMUNICATED TO A THIRD PARTY WITHOUT THE EXPRESS WRITTEN PERMISSION OF AN OFFICER OF QUALTEK ELECTRONICS.

REVISION			
REV.	DESCRIPTION	DATE	APPROVED

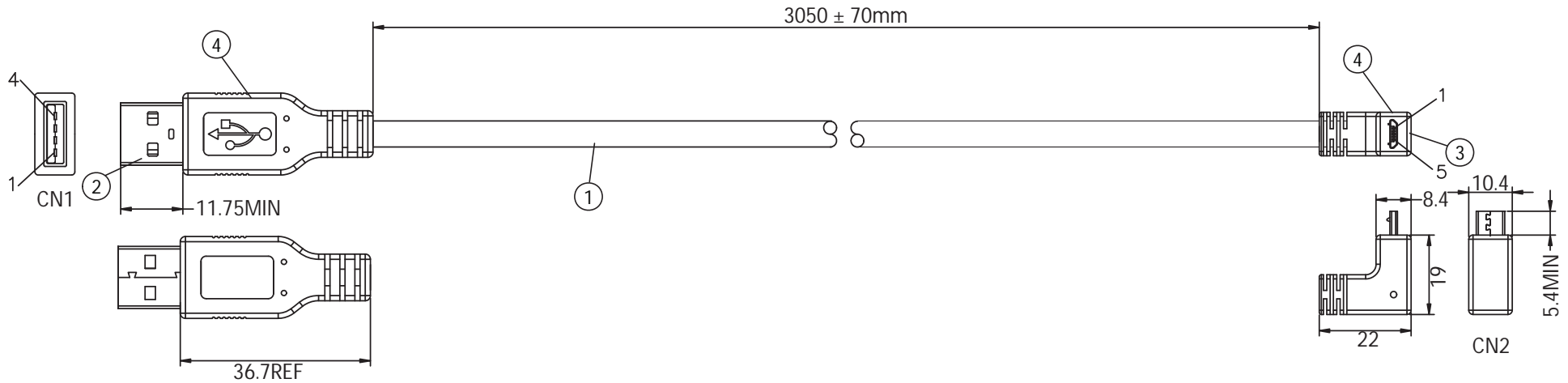

CONNECTION

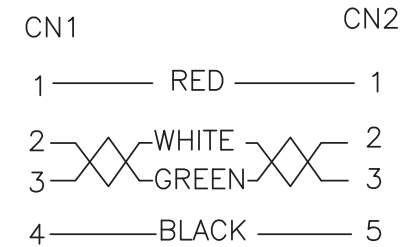

SHELL — BRAID&DRAIN — SHELL

NOTES:

- CABLE: UL2725
28AWGx1PR+24AWGx2C+ AEB(AL) 65%
OUTER JACKET: WHITE, OD: 4.5 ± 0.2mm
- CONNECTOR: USB 2.0 A TYPE MALE
INSULATOR: WHITE PBT
PIN G/F
NICKEL PLATED SHELL
- CONNECTOR: MICRO USB 2.0 (B) 5P/M TYPE MALE
INSULATOR: BLACK PBT
PIN G/F
NICKEL PLATED SHELL
- PVC MOLDED: COLOR 45P WHITE
- ELECTRICAL TEST:
<1>.100% OPEN SHORT & MISS WIRE TEST
<2>.INSULATION RESISTANCE: AC 300V DC300V 10M ohm MIN.
<3>.CONDUCTOR RESISTANCE: 1 ohm MAX.
- PACKING: 1PC/POLYBAG W/ LABEL

CONTROLLED

Dim range (mm)	Tolerance +/- (mm)	Qualtek Electronics Corp. WCI DIVISION		
		Part Number: 3021086-10		RoHS Compliant
0-1	0.15	Description: USB 4P(A)/M - MICRO USB 5P(B)/M		
1-6	0.20			
6-18	0.30	UNIT: mm		
18-50	0.50	UNIT: mm		
50-120	0.70	Drawn / Date	Checked / Date	Approved / Date
120-250	0.90	R. Nuti 04-06-18	04-06-18	LY / 04-06-18
250-500	1.20			

Mouser Electronics

Authorized Distributor

Click to View Pricing, Inventory, Delivery & Lifecycle Information:

[Qualtek:](#)

[3021086-10](#)