



Certifications & Ratings

- IP66
- NEMA 4X
- RoHS Compliant w/6C exemption

Application

The 556 Series LED Panel Mount Indicators incorporate both InGaN and AlInGaP technologies to offer maximum light output. This is a highly durable package, designed to withstand outdoor applications susceptible to rain, dust and sunlight:

- Instrument panels
- Safety applications
- UL 508 panel applications
- Agricultural controls
- Power Generators
- Environmental Monitoring Equipment
- Ground support vehicles
- Pump system controllers
- Transportation - rail, bus, airline
- Lane control
- Display lighting
- ...and many more!

Mechanical information

Mounting Hole Size: 1.0" (25.4 mm)
Max Panel Thickness: 0.600" (15.24 mm)
Mounting Torque: 40 in-lbs

Specifications

Voltage Options: 18–48 VDC
 (internal resistor included)

Operating Temp: -30 °C to +85 °C (-22 °F to +185 °F)

Storage Temp: -40 °C to +100 °C (-40 °F to +212 °F)

Electrical Connection: 6-32 screw terminals

Housing: Brass—White or Black Nickel Plated

Terminals: Brass — Hot solder dip
 per Mil-F-14072D, M258, Type II

Lens Material: Clear UV Stabilized Polycarbonate
 (UL 94V-0)

Lock Washer: Phosphor Bronze — White or Black
 Nickel Plated

Nut: Brass—White or Black Nickel Plated

Dimensions

inches [mm]

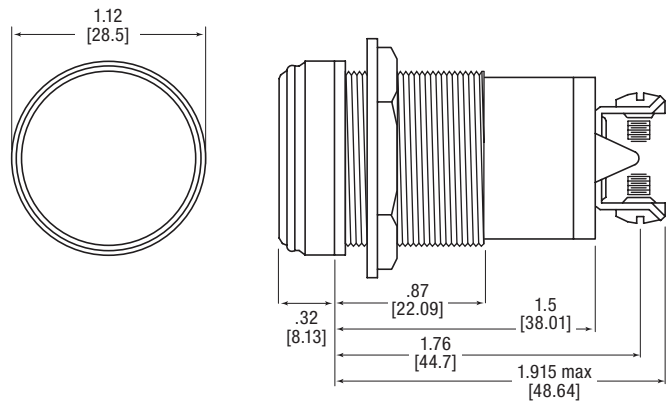

Ordering Information

556 Series – Daylight Viewable Constant Intensity

Part Number Guide 556 Series *RoHS Compliant*

5 5 6 - 1 X X A - X 1 4 F

Color	5	0
Red	5	0
Green	6	0
Yellow	7	0

Voltage
A 18–48 VDC

Plating
2 Black
3 White

White Nickel	Black Nickel	Color	Voltage (VDC)	Typ Current (mA)	Typical Intensity (mcd)
556-150A-314F	556-150A-214F	Red	18–48	7.3–8.2	400
556-160A-314F	556-160A-214F	Green		6.5–7.4	170
556-170A-314F	556-170A-214F	Yellow		8.0–8.9	310

Dialight reserves the right to make changes at any time in order to supply the best product possible. The most current version of this document will always be available at: www.dialightsignalsandcomponents.com

Warranty Statement: Except for the warranty expressly provided for [herein/above/below], Dialight disclaims any and all other warranties, express or implied, including, without limitation, any warranties of merchantability, fitness for a particular purpose, title, and noninfringement.