

UHF BAND LOW NOISE AMPLIFIER GaAs MMIC

■ GENERAL DESCRIPTION

The NJG1139UA2 is a low noise amplifier GaAs MMIC designed for mobile digital TV application (470~770 MHz).

This IC has a LNA pass-through function to select high gain mode or low gain mode by single bit control.

Also, the ESD protection circuit is integrated into the IC to achieve high ESD tolerance.

An ultra-small and ultra-thin package of EPFFP6-A2 is adopted.

■ PACKAGE OUTLINE

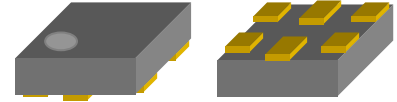

NJG1139UA2

■ FEATURES

- Low voltage operation +1.8V typ.
 - Low voltage control +1.8V typ.
 - Package EPFFP6-A2 (Package size: 1.0mm x 1.0mm x 0.37mm typ.)
 - External matching parts 2pcs.
- [High gain mode]
- Low current consumption 3.5mA typ.
 - High gain 14.0dB typ.
 - Low noise figure 1.2dB typ.
 - High input IP3 -4.0dBm typ.
- [Low gain mode]
- Low current consumption 11μA typ.
 - Gain (Low loss) -2.0dB typ.
 - High input IP3 +30.0dBm typ.

■ PIN CONFIGURATION

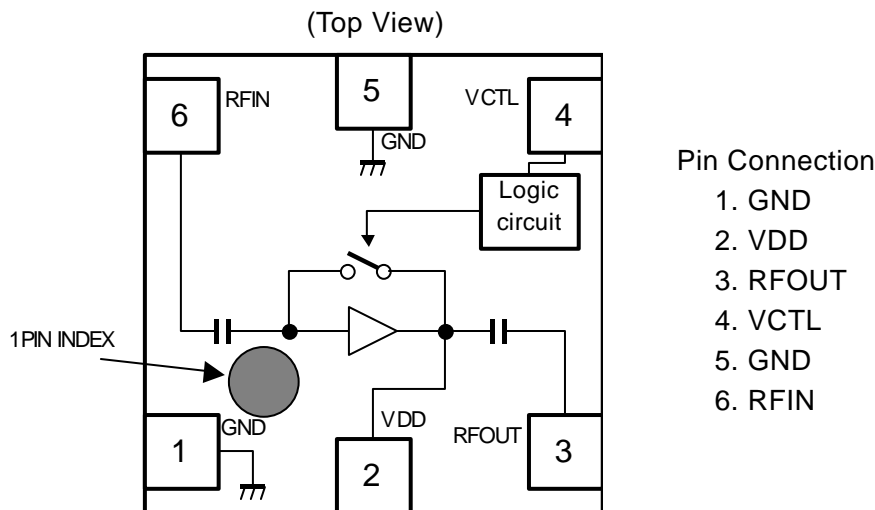

■ TRUTH TABLE

“H”= $V_{CTL(H)}$, “L”= $V_{CTL(L)}$

V_{CTL}	LNA ON	Bypass	LNA mode
H	ON	OFF	High Gain mode
L	OFF	ON	Low Gain mode

Note: Specifications and description listed in this datasheet are subject to change without notice.

NJG1139UA2

■ ABSOLUTE MAXIMUM RATINGS

$T_a=+25^{\circ}\text{C}$, $Z_s=Z_i=50\ \text{ohm}$

PARAMETER	SYMBOL	CONDITIONS	RATINGS	UNITS
Drain voltage	V_{DD}		5.0	V
Control voltage	V_{CTL}		5.0	V
Input power	P_{IN}	$V_{DD}=1.8\text{V}$	+15	dBm
Power dissipation	P_D	4-layer FR4 PCB with through-hole (101.5x114.5mm), $T_j=150^{\circ}\text{C}$	590	mW
Operating temperature	T_{opr}		-40~+95	$^{\circ}\text{C}$
Storage temperature	T_{stg}		-55~+150	$^{\circ}\text{C}$

■ ELECTRICAL CHARACTERISTICS1 (DC CHARACTERISTICS)

General conditions: $V_{DD}=1.8\text{V}$, $T_a=+25^{\circ}\text{C}$, $Z_s=Z_i=50\ \text{ohm}$, with application circuit

PARAMETERS	SYMBOL	CONDITIONS	MIN	TYP	MAX	UNITS
Operating voltage	V_{DD}		1.7	1.8	3.6	V
Control voltage (High)	$V_{CTL(H)}$		1.5	1.8	3.6	V
Control voltage (Low)	$V_{CTL(L)}$		0	0	0.4	V
Operating current1	I_{DD1}	RF OFF, $V_{CTL}=1.8\text{V}$	-	3.5	5.0	mA
Operating current2	I_{DD2}	RF OFF, $V_{CTL}=0\text{V}$	-	11	25	μA
Control current	I_{CTL}	RF OFF, $V_{CTL}=1.8\text{V}$	-	6	10	μA

■ ELECTRICAL CHARACTERISTICS2 (High Gain mode)

General conditions: $V_{DD}=1.8V$, $V_{CTL}=1.8V$, $T_a=+25^{\circ}C$, $Z_s=Z_l=50\text{ ohm}$, with application circuit

PARAMETERS	SYMBOL	CONDITIONS	MIN	TYP	MAX	UNITS
Operating frequency	f_{RF}		470	620	770	MHz
Small signal gain1	Gain1		11.0	14.0	17.0	dB
Noise figure	NF	Exclude PCB & connector losses*1	-	1.2	1.7	dB
Input power at 1dB gain compression point1	$P_{-1dB(IN)1}$		-18.0	-12.0	-	dBm
Input 3rd order intercept point1	IIP3_1	$f1=f_{RF}$, $f2=f_{RF}+100kHz$, $P_{IN}=-25dBm$	-8.0	-4.0	-	dBm
RF IN VSWR1	VSWRi1		-	1.5	4.9	-
RF OUT VSWR1	VSWRo1		-	1.5	3.0	-

■ ELECTRICAL CHARACTERISTICS3 (Low Gain mode)

General conditions: $V_{DD}=1.8V$, $V_{CTL}=0V$, $T_a=+25^{\circ}C$, $Z_s=Z_l=50\text{ ohm}$, with application circuit

PARAMETERS	SYMBOL	CONDITIONS	MIN	TYP	MAX	UNITS
Operating frequency	f_{RF}		470	620	770	MHz
Small signal gain2	Gain2	Exclude PCB & connector losses*2	-2.5	-2.0	-	dB
Input power at 1dB gain compression point2	$P_{-1dB(IN)2}$		+5.0	+15.0	-	dBm
Input 3rd order intercept point2	IIP3_2	$f1=f_{RF}$, $f2=f_{RF}+100kHz$, $P_{IN}=-8dBm$	+15.0	+30.0	-	dBm
RF IN VSWR2	VSWRi2		-	1.5	2.5	-
RF OUT VSWR2	VSWRo2		-	1.5	2.5	-

*1 Input PCB and connector losses: 0.033dB(at 470MHz), 0.047dB(at 770MHz)

*2 Input & output PCB and connector losses: 0.057dB(at 470MHz), 0.085dB(at 770MHz)

■ TERMINAL INFORMATION

No.	SYMBOL	DESCRIPTION
1	GND	Ground terminal. These terminals should be connected to the ground plane as close as possible for excellent RF performance.
2	VDD	This terminal is a power supply terminal of LNA and the logic circuit. Inductor L2 as shown in the application circuit is a part of an external matching circuit, and also provide DC power to LNA.
3	RFOUT	RF input terminal. Since this IC is integrated an input DC blocking capacitor.
4	VCTL	Control voltage supply terminal.
5	GND	Ground terminal. These terminals should be connected to the ground plane as close as possible for excellent RF performance.
6	RFIN	RF input terminal. The RF signal is input through external matching circuit connected to this terminal. Since this IC is integrated an input DC blocking capacitor.

■ ELECTRICAL CHARACTERISTICS (High Gain mode)

Conditions: $T_a=+25^\circ\text{C}$, $V_{DD}=1.8\text{V}$, $V_{CTL}=1.8\text{V}$, $Z_s=Z_l=50\ \text{ohm}$, with application circuit

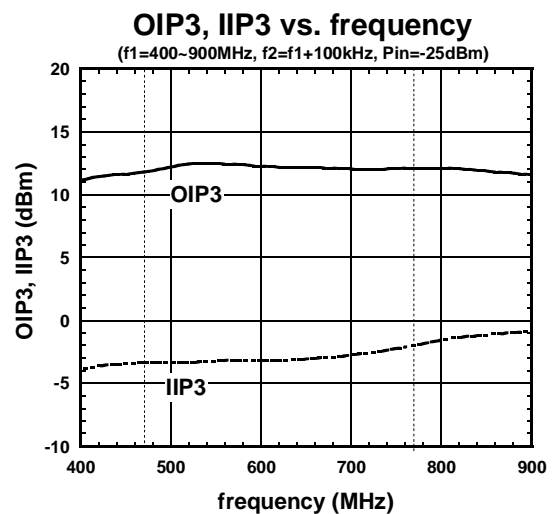
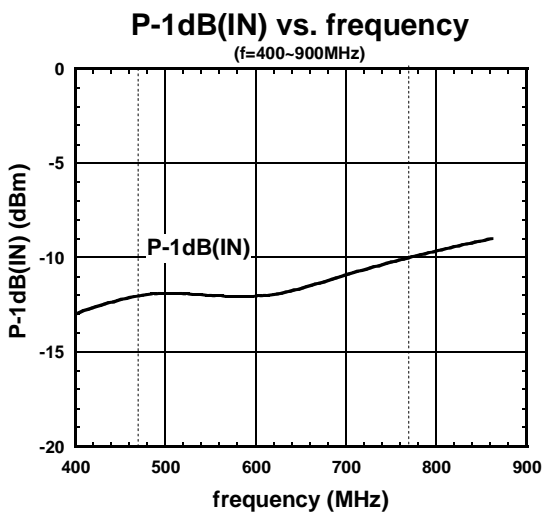
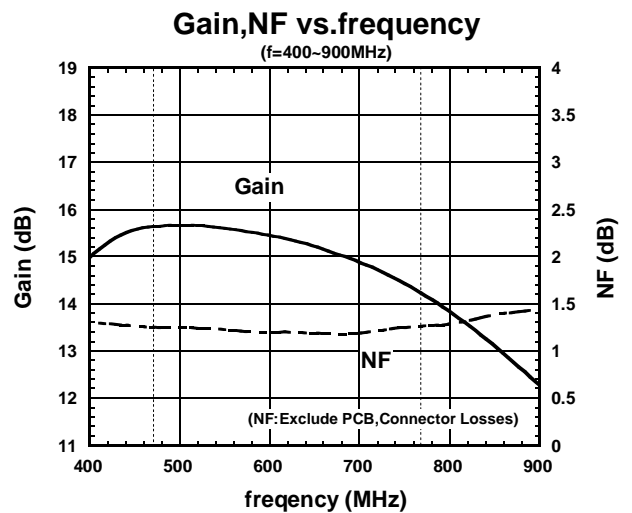
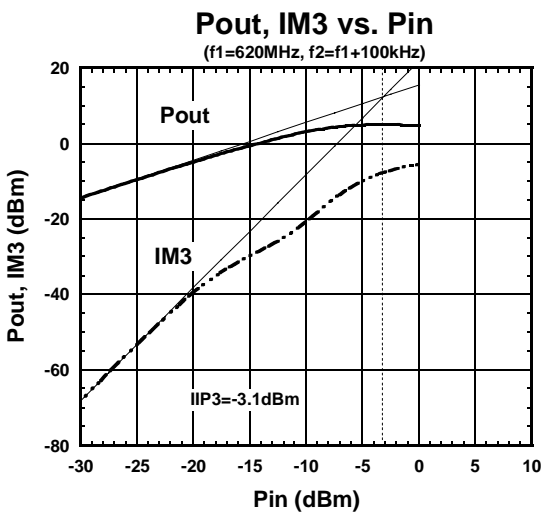
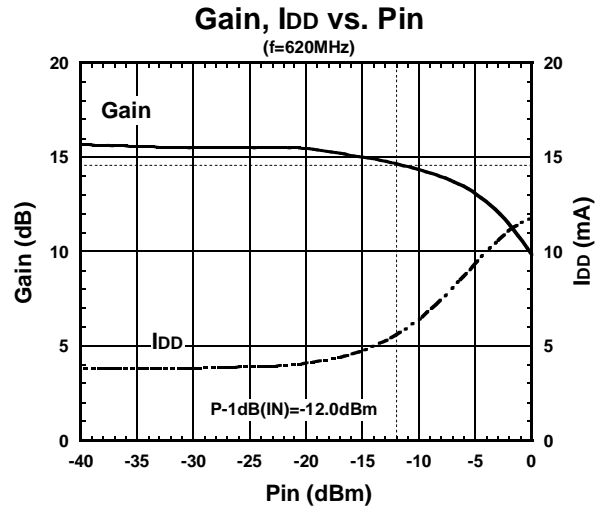
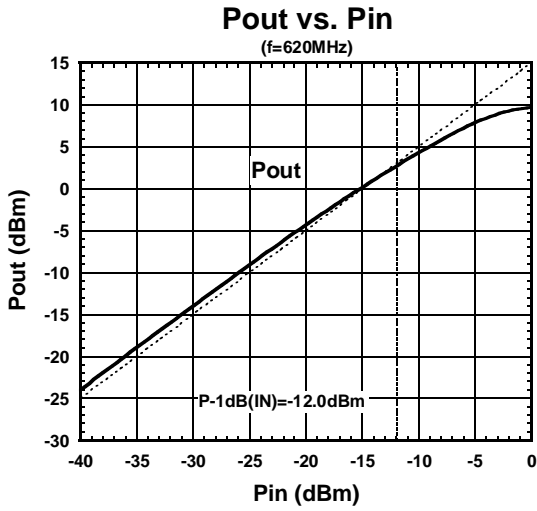

NJG1139UA2

■ ELECTRICAL CHARACTERISTICS (High Gain mode)

Conditions: $T_a=+25^\circ\text{C}$, $V_{\text{CTL}}=1.8\text{V}$, $Z_s=Z_l=50\ \text{ohm}$, with application circuit

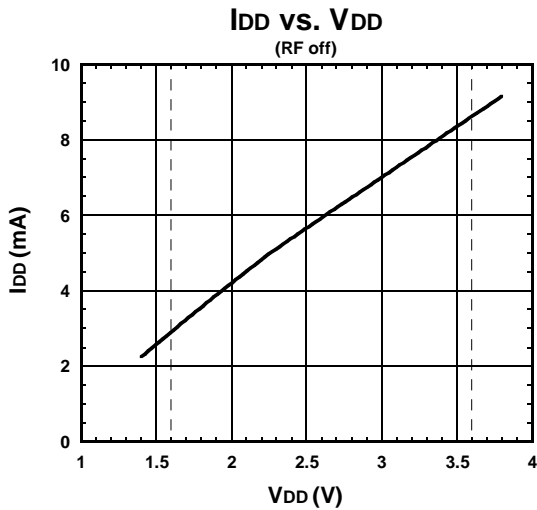
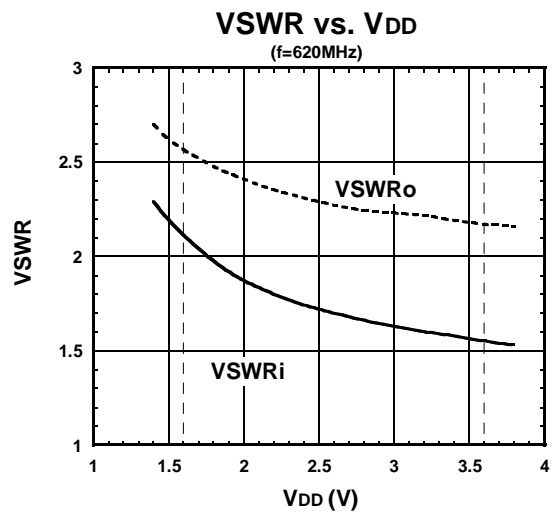
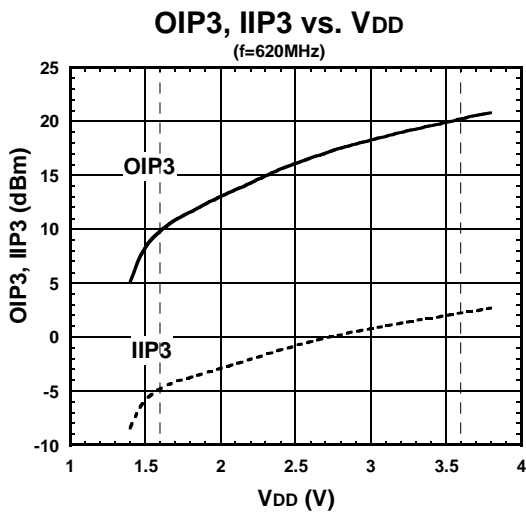
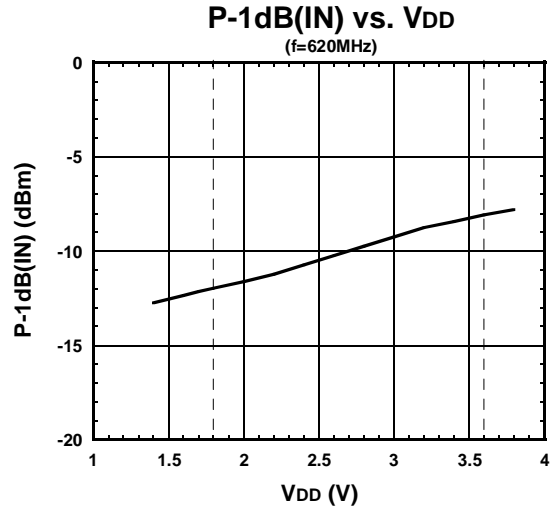
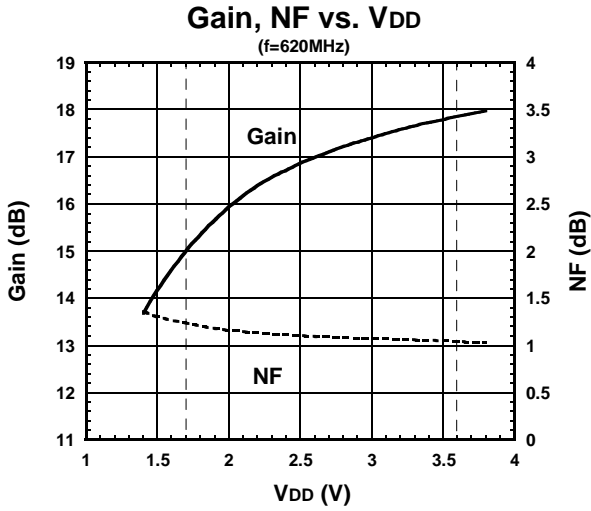

■ ELECTRICAL CHARACTERISTICS (High Gain mode)

Conditions: $V_{DD}=1.8V$, $V_{CTL}=1.8V$, $Z_s=Z_l=50\text{ ohm}$, with application circuit

Gain, NF vs. Temperature

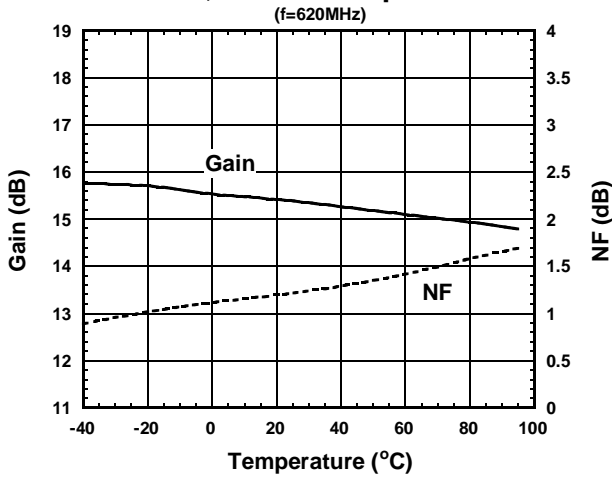

P-1dB(IN) vs. Temperature

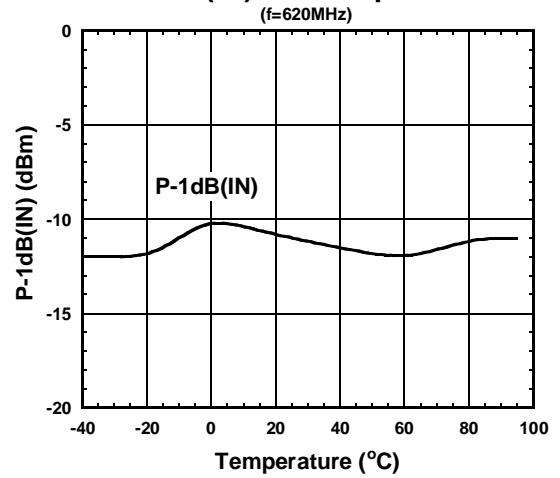

OIP3, IIP3 vs. Temperature

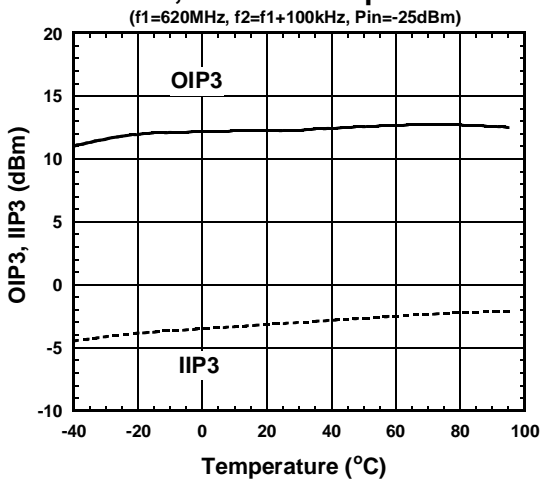

VSWR vs. Temperature

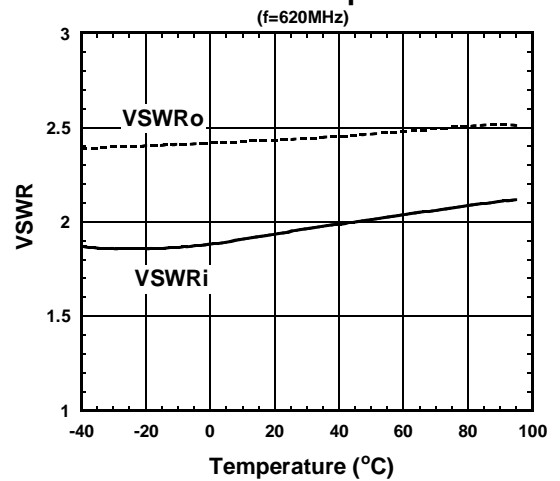

I_{DD} vs. Temperature

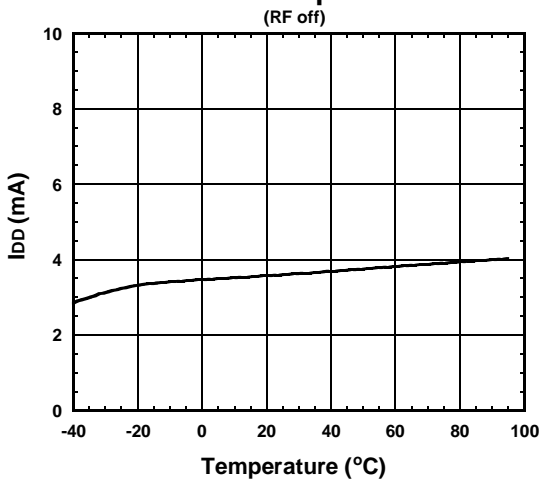

K factor vs. Temperature

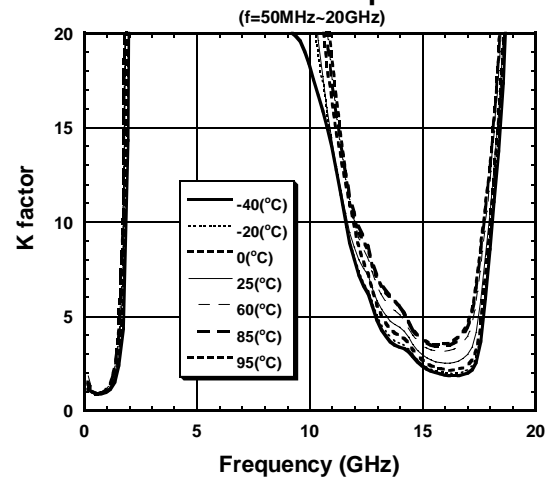

NJG1139UA2

■ ELECTRICAL CHARACTERISTICS (High Gain mode)

Conditions: $T_a=+25^{\circ}\text{C}$, $V_{DD}=1.8\text{V}$, $V_{CTL}=1.8\text{V}$, $Z_S=Z_I=50\ \text{ohm}$, with application circuit

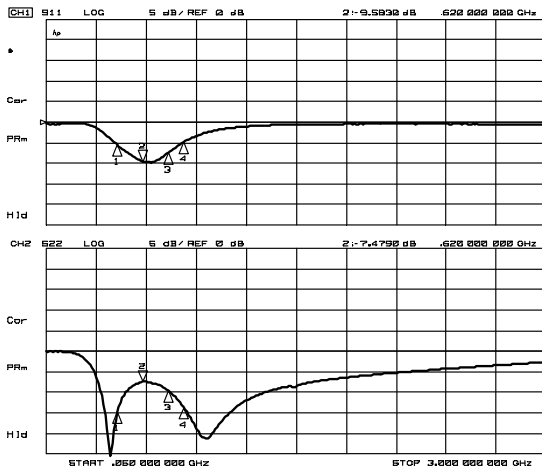

S11, S22

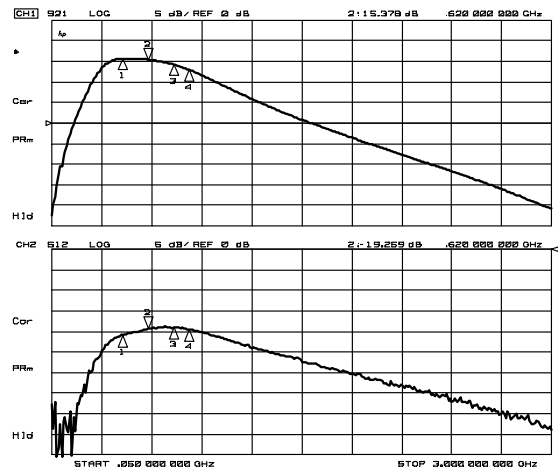

S21, S12

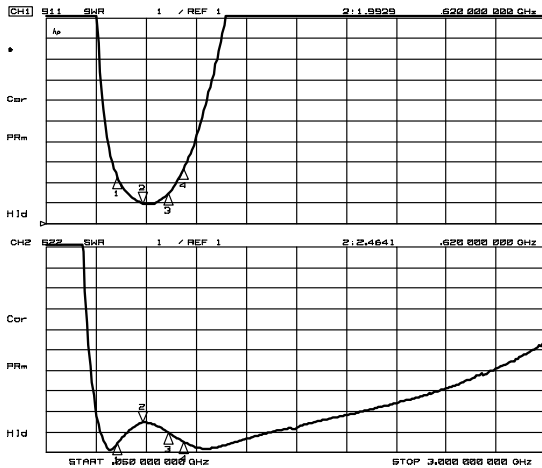

VSWRi, VSWRo

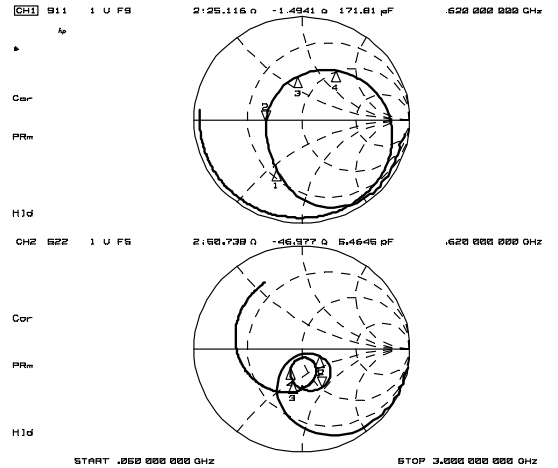

Zin, Zout

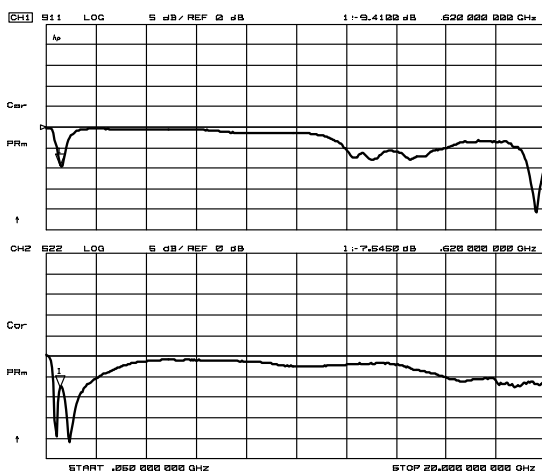

S11, S22 (50MHz~20GHz)

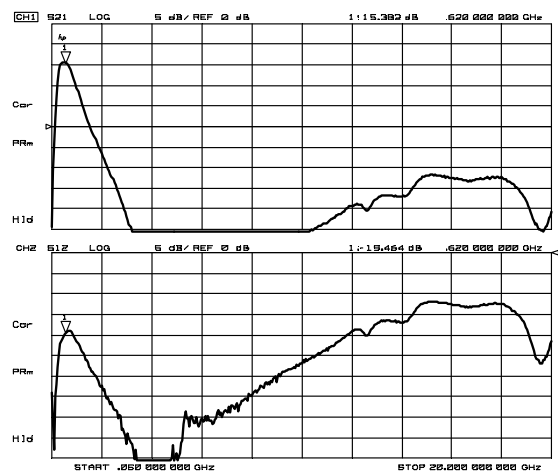

S21, S12 (50MHz~20GHz)

■ ELECTRICAL CHARACTERISTICS (Low Gain mode)

Conditions: $T_a=+25^\circ\text{C}$, $V_{DD}=1.8\text{V}$, $V_{CTL}=0\text{V}$, $Z_s=Z_l=50\ \text{ohm}$, with application circuit

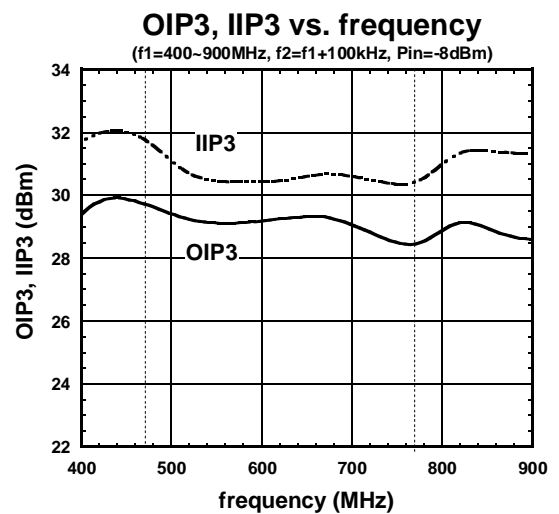
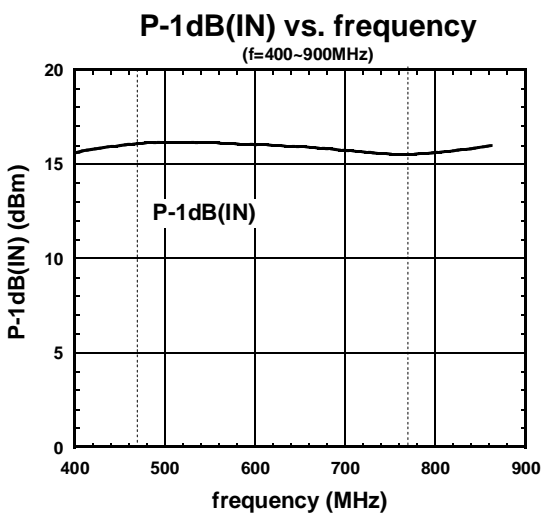
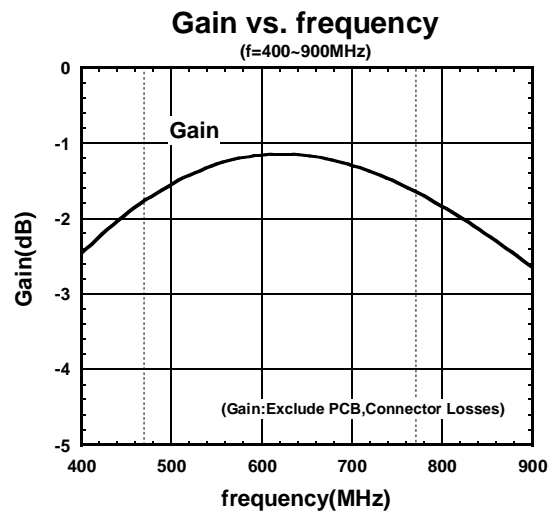
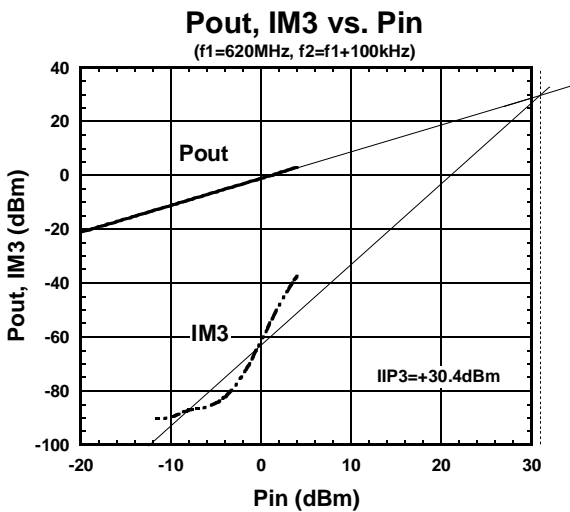
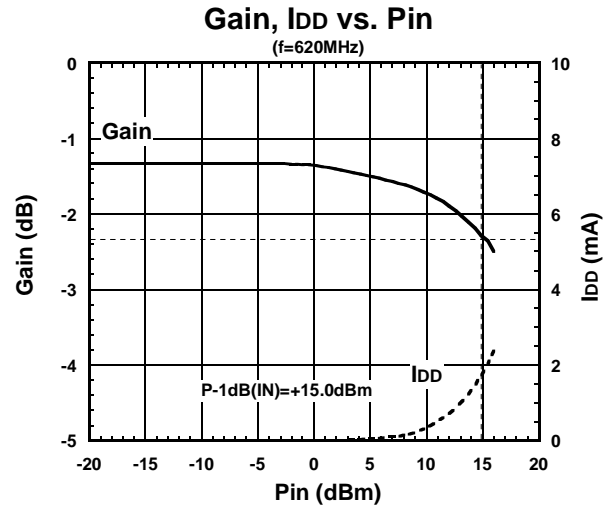
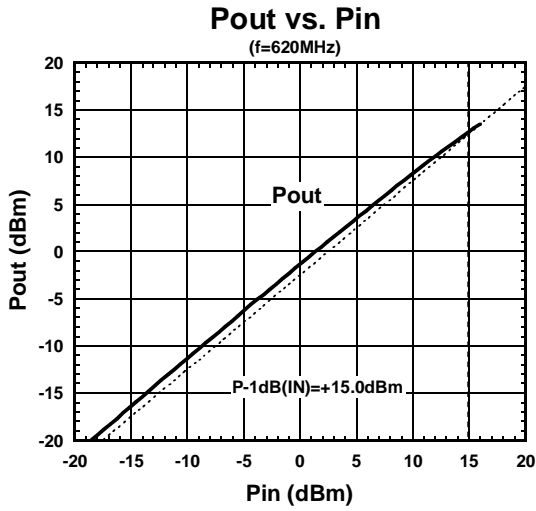

NJG1139UA2

■ ELECTRICAL CHARACTERISTICS (Low Gain mode)

Conditions: $T_a=+25^{\circ}\text{C}$, $V_{\text{CTL}}=0\text{V}$, $Z_s=Z_l=50\ \text{ohm}$, with application circuit

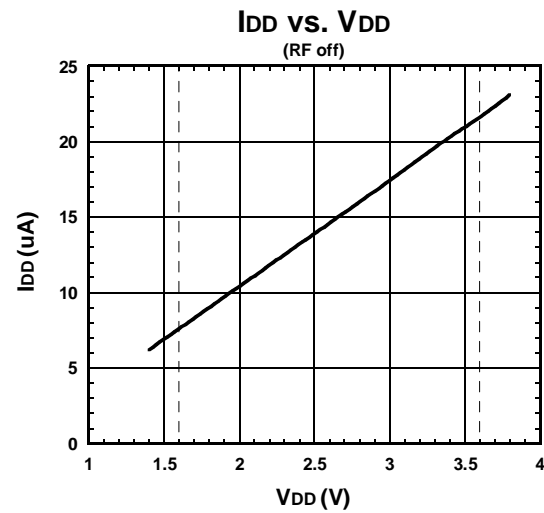
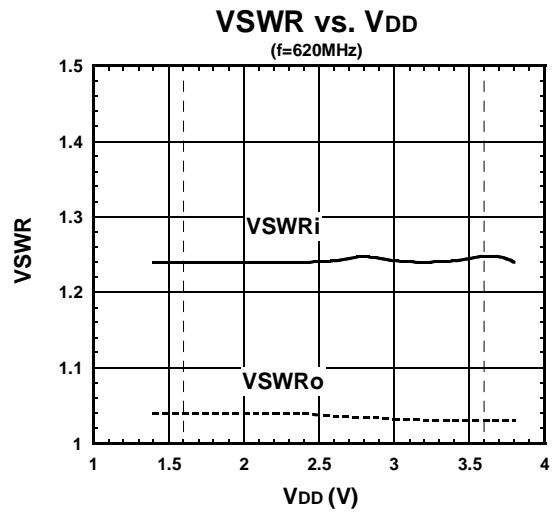
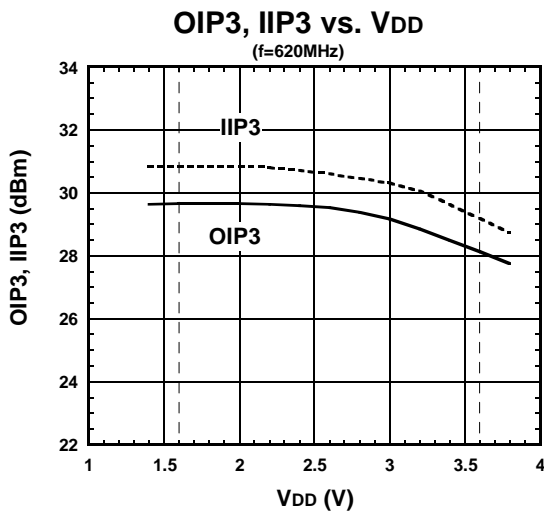
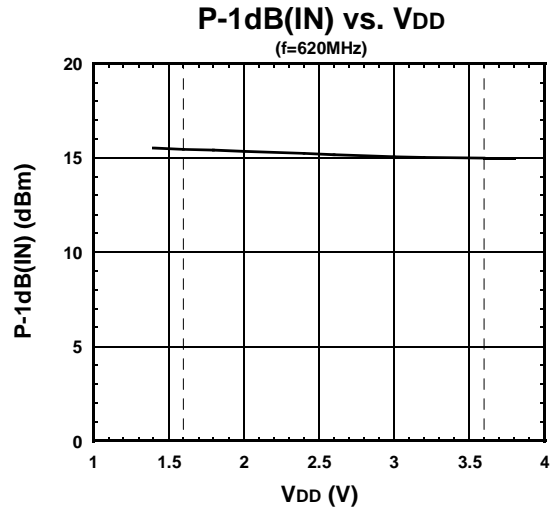
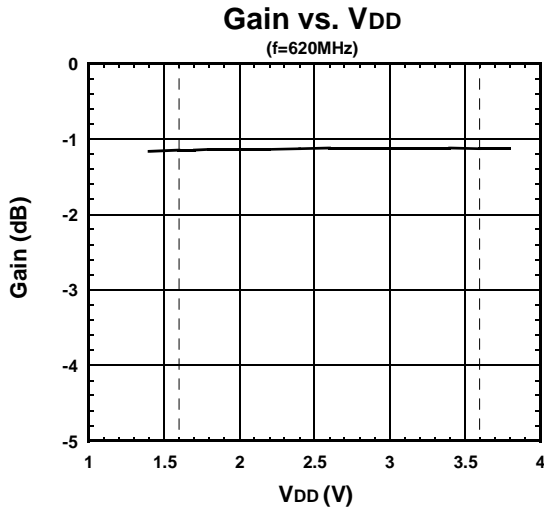

■ ELECTRICAL CHARACTERISTICS (Low Gain mode)

Conditions: $V_{DD}=1.8V$, $V_{CTL}=0V$, $Z_s=Z_l=50\text{ ohm}$, with application circuit

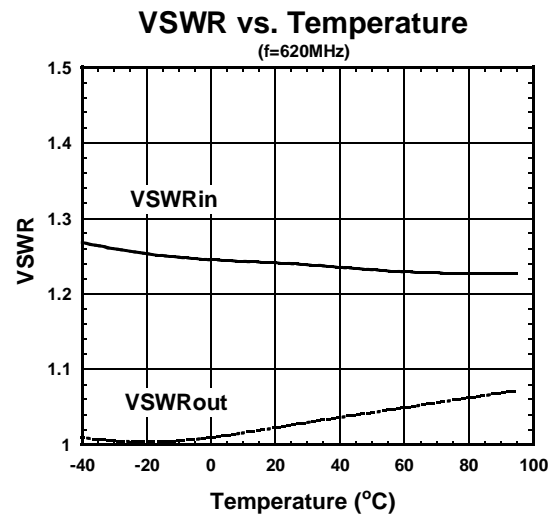
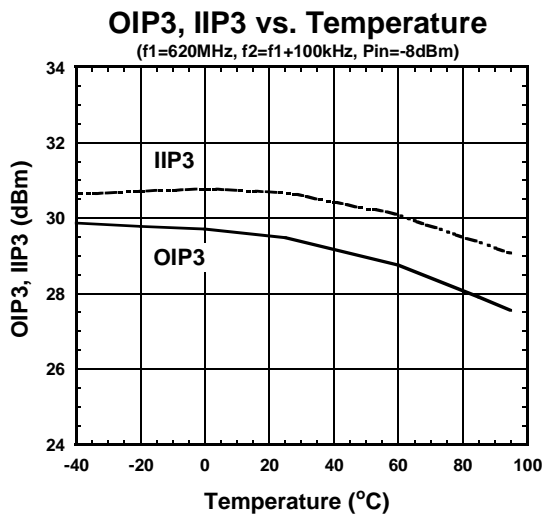
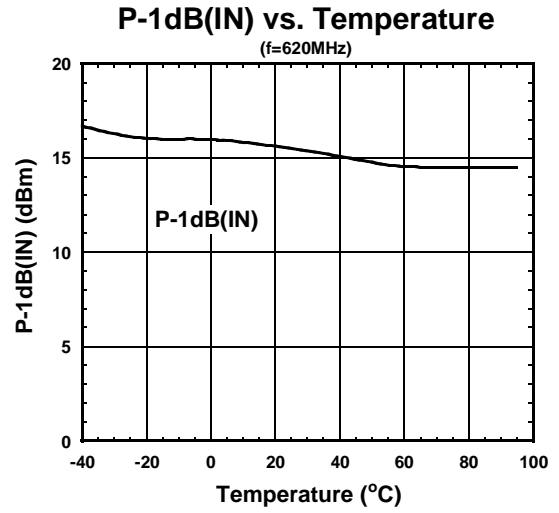
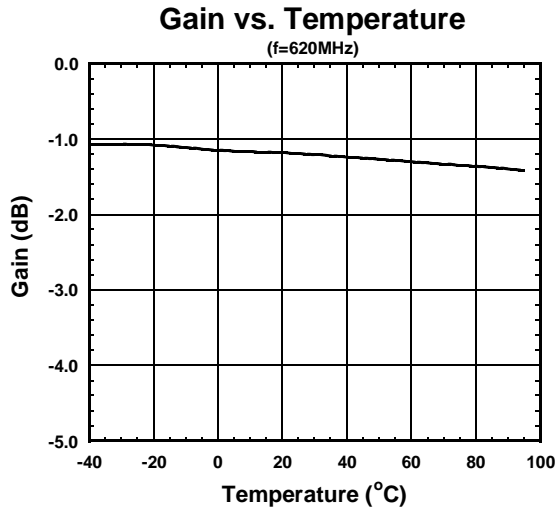

NJG1139UA2

■ ELECTRICAL CHARACTERISTICS (Low Gain mode)

Conditions: $V_{DD}=1.8V$, $V_{CTL}=0V$, $Z_s=Z_l=50\text{ ohm}$, with application circuit

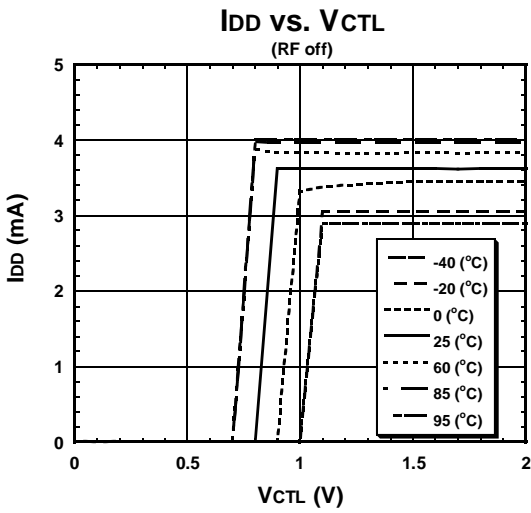
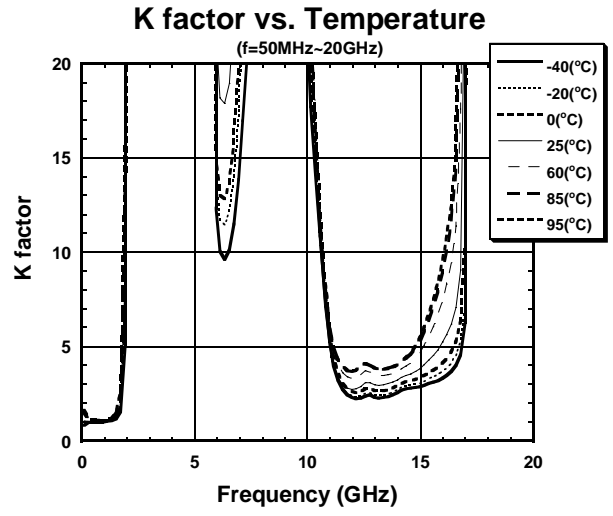
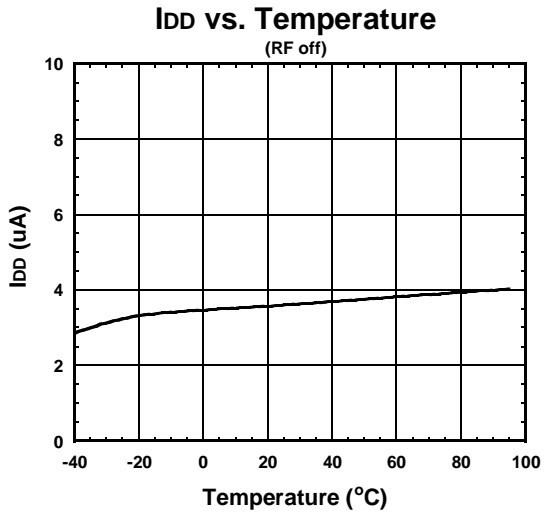

ELECTRICAL CHARACTERISTICS (Low Gain mode)

Conditions: $T_a=+25^{\circ}\text{C}$, $V_{DD}=1.8\text{V}$, $V_{CTL}=0\text{V}$, $Z_S=Z_L=50\text{ ohm}$, with application circuit

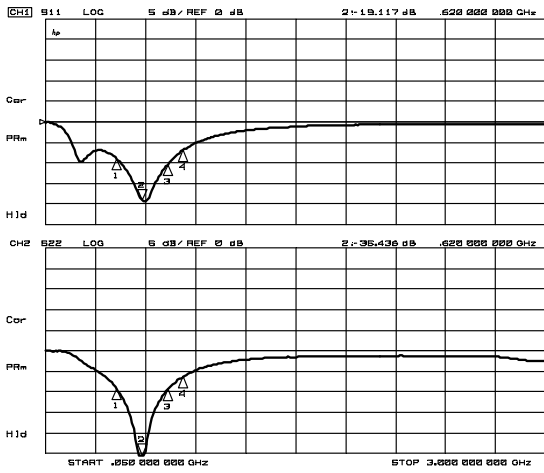

S11, S22



S21, S12

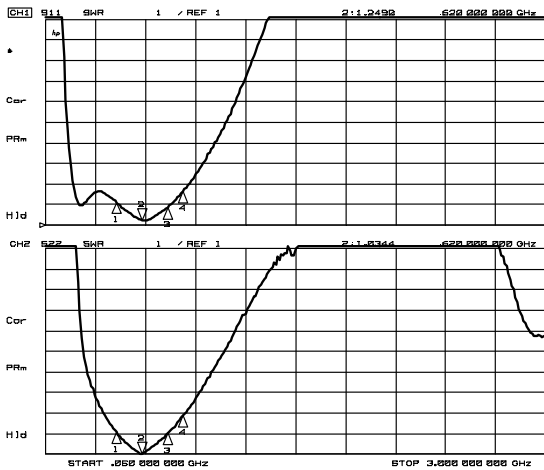

VSWRi, VSWRo

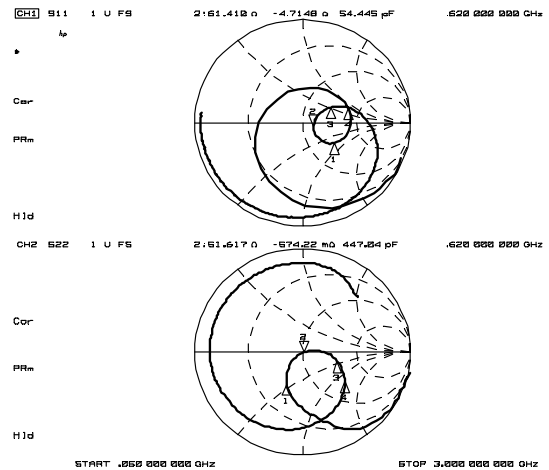

Zin, Zout

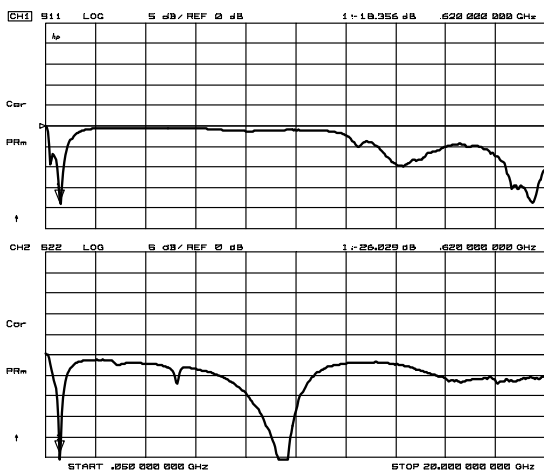

S11, S22 (50MHz~20GHz)

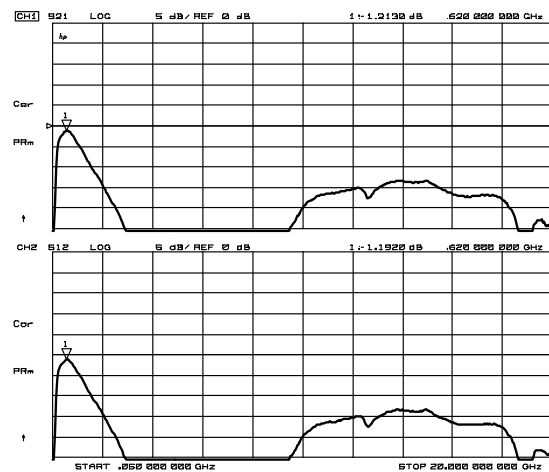

S21, S12 (50MHz~20GHz)

NJG1139UA2

APPLICATION CIRCUIT

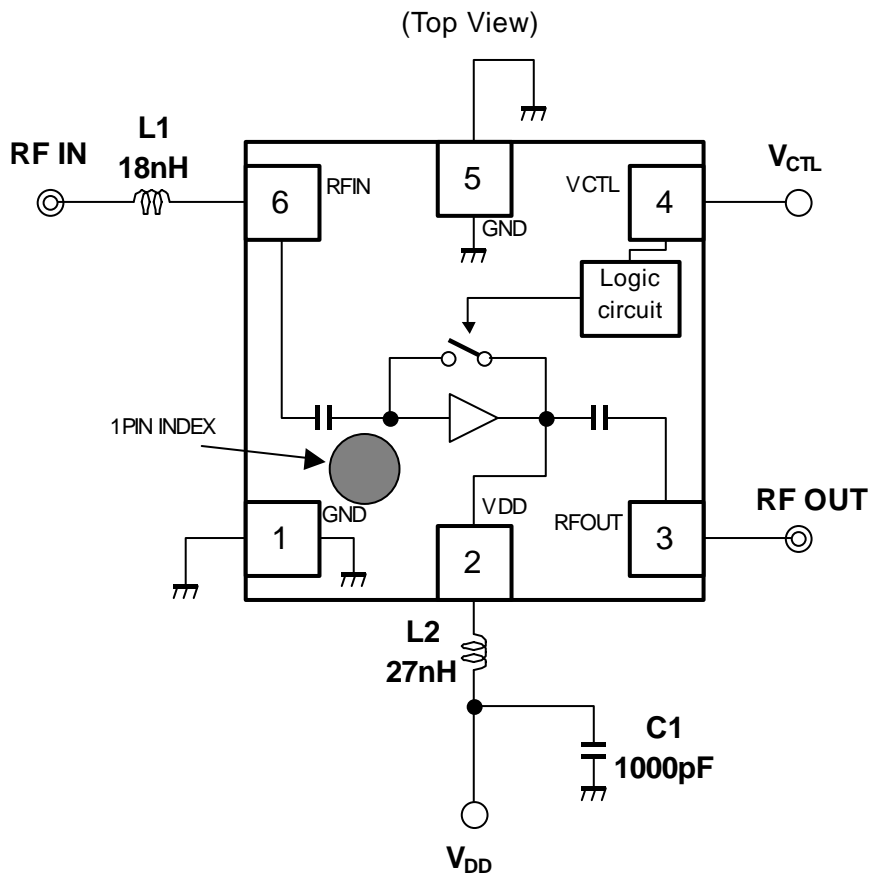

TEST PCB LAYOUT

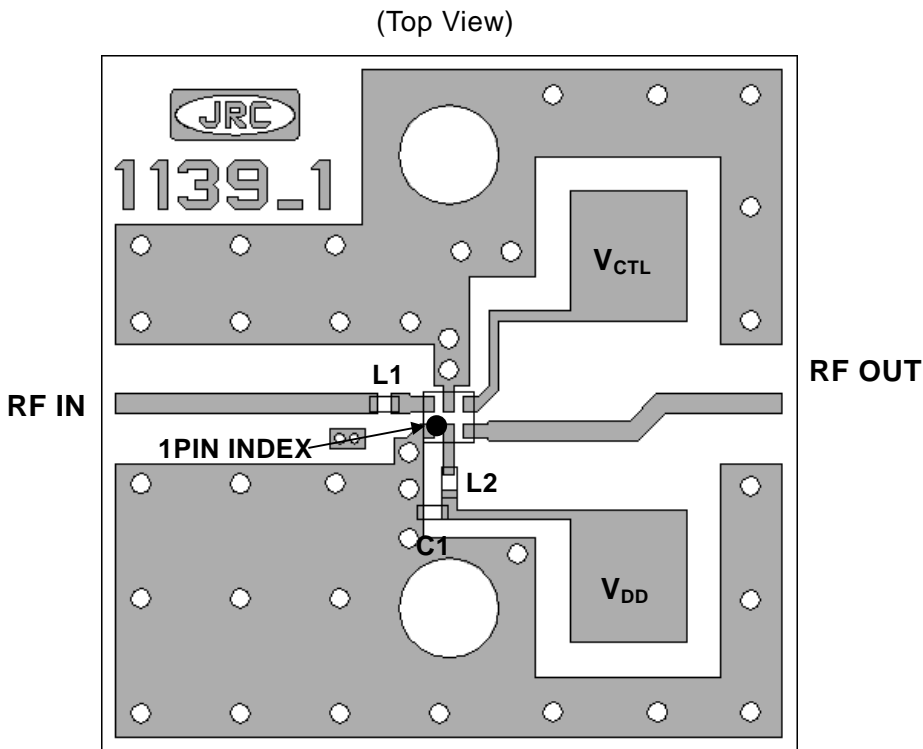

Parts List

Parts ID	Notes
L1, L2	MURATA LQP03T series
C1	MURATA GRM03 series

PCB (FR-4):
 t=0.2mm
 MICROSTRIP LINE WIDTH
 =0.4mm ($Z_0=50 \text{ ohm}$)
 PCB SIZE=14.0mm × 14.0mm

* Please place all external parts around the IC as close as possible.

PACKAGE OUTLINE (EPFFP6-A2)

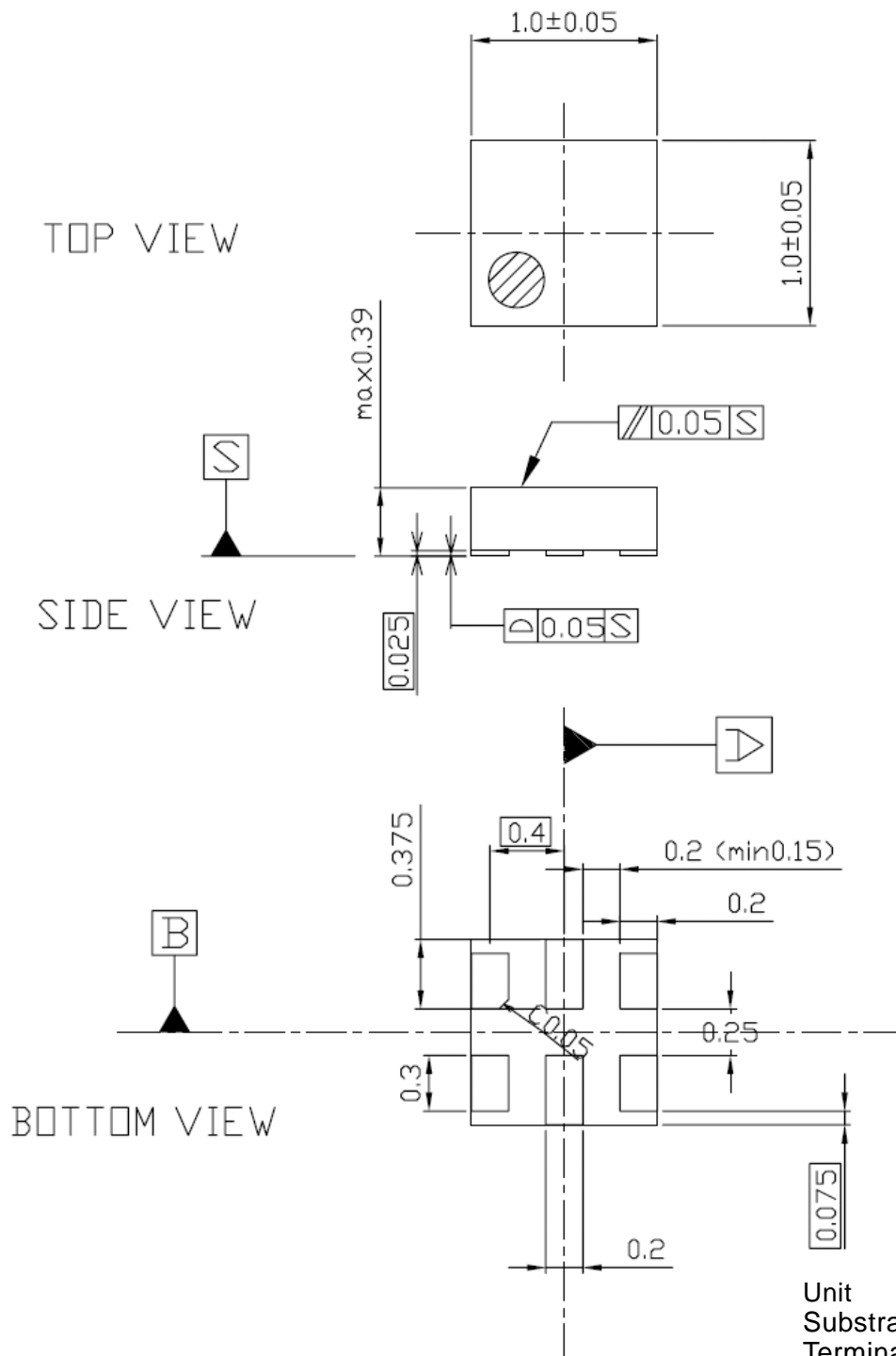

Unit	: mm
Substrate	: FR4
Terminal treat	: Au
Molding material	: Epoxy resin
Weight (typ.)	: 0.855mg

Cautions on using this product

- This product contains Gallium-Arsenide (GaAs) which is a harmful material.
- Do NOT eat or put into mouth.
 - Do NOT dispose in fire or break up this product.
 - Do NOT chemically make gas or powder with this product.
 - To waste this product, please obey the relating law of your country.

[CAUTION]

The specifications on this databook are only given for information, without any guarantee as regards either mistakes or omissions. The application circuits in this databook are described only to show representative usages of the product and not intended for the guarantee or permission of any right including the industrial rights.

This product may be damaged with electric static discharge (ESD) or spike voltage. Please handle with care to avoid these damages.