

Typical Specifications

Items		Specifications
Rating (max.)/(min.) (Resistive load)		0.15A 12V DC / 50μA 3V DC
Contact resistance (Initial / After operating life)		50mΩ max. / 100mΩ max.
Rotational torque		70±30mN·m
Operating life	Without load	10,000 cycles
	With load	10,000 cycles (0.15A 12V DC)

Product Line

Number of wafers	Poles	Positions	Changeover angle	Changeover timing	Actuator configuration	Actuator length (mm)	Minimum order unit (pcs.)		Product No.	Drawing No.
							Japan	Export		
1	2	5	30±3°	Non shorting	Round	20	60	240	SRRN151800	1
		Flat			15	SRRN152000				
	6	18-tooth serration			20	SRRN161100				
	3	Round				SRRN142100			2	
	4	3			18-tooth serration	15			SRRN134300	

Note

All the axis are cutting shafts.

Packing Specifications

Tray

Number of packages (pcs.)		Export package measurements (mm)
1 case /Japan	1 case /export packing	
60	240	400×270×270

Dimensions

Unit:mm

No.	Style
1	

Refer to P.147 for shaft configurations.
Refer to P.148 for soldering conditions.

SRRN 6-position Vertical Type

Detector

Slide

Push

Rotary

Power

Dual-in-line
Package Type

Dimensions

Unit:mm

No.	Style
2	<p>Technical drawing of SRRN style 2. It includes three views: a top view showing terminal positions 1-6, a side view showing a total length of 16 max. with segments of 11.3, 8, 5, and 6, and a mounting hole of $M7 \times 0.75$ at a distance of $L \pm 0.5$ from the end. The front view shows a diameter of $\phi 24$ and a central hole of $\phi 19.2$. Other dimensions include 8.4, 8, 23.6, 5.8, and a hole diameter of $\phi 3_{-0.2}^0$.</p>
3	<p>Technical drawing of SRRN style 3. It includes three views: a top view showing terminal positions 1-6, a side view showing a total length of 16 max. with segments of 11.3, 8, 5, and 6, and a mounting hole of $M7 \times 0.75$ at a distance of $L \pm 0.5$ from the end. The front view shows a diameter of $\phi 24$ and a central hole of $\phi 19.2$. Other dimensions include 8.4, 8, 23.6, 5.8, and a hole diameter of $\phi 3_{-0.2}^0$.</p>

Terminal Configuration

Unit:mm

Common terminal	Terminal
<p>Diagram of a common terminal with dimensions: 2.4 mm width, 1.8 mm offset, 0.8x1.6 mm hole, 0.5 mm height, and 2.4 mm total height.</p>	<p>Diagram of a terminal with dimensions: 1.8 mm width, 0.8x1.6 mm hole, 0.5 mm height, and 2.4 mm total height.</p>

Standard Circuit Diagram (Standard Poles Per Step)

Number of poles	2		3		4	
Circuit diagram						
Dummy terminals	5-position	17 8	4-position	—	3-position	—
	6-position	—				

Note

The mark in the above table indicate a stopper with the shaft turned fully counterclockwise when viewed from direction A of the diagrams.

18-tooth Serration Shaft

The shaft shows the position in which it is turned fully counterclockwise.

Cutting Shaft

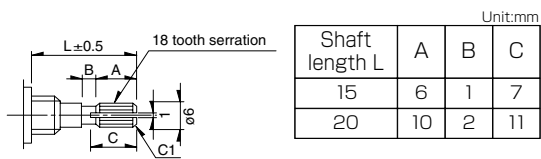

Details About Serration

- (1) The mold dimensions of standard serration and the dimensions of test jigs are as shown in the figure at left.
- (2) Position of the serration bottom
When the shaft is turned fully counterclockwise, the position of the serration bottom is on the AA line.
- (3) Slitting angle
The slitting angle (position) is not specified.

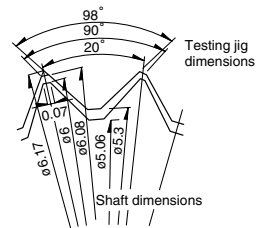

Round Shaft

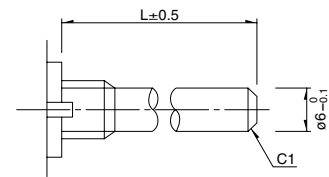

Flat Shaft

The shaft shows the position in which it is turned fully counterclockwise.

Cutting Shaft

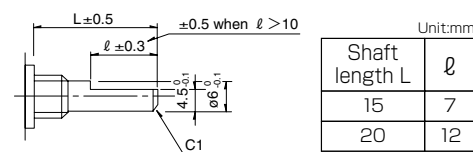

Shaft flatten angle	

Note





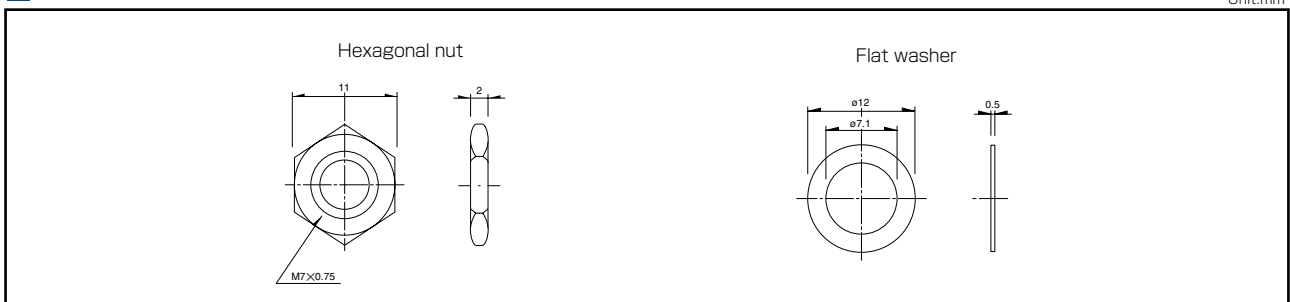







SRRM Series are based on (panel lug).

Attached Parts



Rotary Switches

List of Varieties

Series	SRBD	SRBQ		SRBM		SRBV	SRRM	SRRN																																								
		Insertion	Reflow type	Rotary	Pulse																																											
Photo																																																
Angle of throw	36°	40±3°		30±3°	18±3°	30±3°																																										
Number of poles	1		1, 2		1	1, 2, 3, 4	2, 3, 4																																									
Rotational torque	13±5mN·m	6±3mN·m 13±5mN·m		40±20mN·m 15±7mN·m		30±15mN·m	80±30mN·m (Shorting) 70±30mN·m (Non shorting)	70±30mN·m																																								
Dimensions (mm)	W	10		10		16.2	—	—																																								
	D	11.4		12.4		18.5																																										
	H	12.4		11		7.5																																										
Operating temperature range	-25°C to +85°C	-10°C to +60°C		-30°C to +85°C		-10°C to +85°C	-10°C to +60°C	-30°C to +65°C																																								
Automotive use	—	—		—		—	—	—																																								
Life cycle																																																
Rating (max.)/(min.) (Resistive load)	1mA 5V DC 50µA 3V DC	0.1A 16V DC 50µA 3V DC				0.3A 16V DC 50µA 3V DC	0.25A 30V DC 50µA 3V DC	0.15A 12V DC 50µA 3V DC																																								
Durability	Operating life without load	10,000 cycles 250mΩ max.	10,000 cycles 100mΩ max.		30,000 cycles 100mΩ max.	10,000 cycles 100mΩ max.	10,000 cycles 40mΩ max.	10,000 cycles 70mΩ max.																																								
	Operating life with load Load: as rating	10,000 cycles 250mΩ max.	10,000 cycles 100mΩ max.	10,000 cycles 150mΩ max.		10,000 cycles 60mΩ max.	10,000 cycles 100mΩ max.																																									
Electrical performance	Initial contact resistance	200mΩ max.	50mΩ max.				20mΩ max.	50mΩ max.																																								
	Insulation resistance	100MΩ min. 100V DC					100MΩ min. 500V DC																																									
	Voltage proof	100V AC for 1minute					500V AC for 1minute																																									
Mechanical performance	Terminal strength	3N for 1minute	5N for 1minute				10N for 1minute	5N for 1minute																																								
	Actuator strength	Operating direction	—	—	0.5N·m	—	0.6N·m	1N·m																																								
		Pulling direction	50N	20N	100N																																											
	Wobble of actuator	Load at the tip of shaft SRRM, SRBM, SRRN: 5N, SRBQ, SRBV: 1N																																														
The below table shows for SRRM, SRBM, SRRN			The below table shows for SRBQ			The below table shows for SRBV																																										
<table border="1"> <thead> <tr> <th>Measuring position from mounting surface</th> <th>Shaft wobble (max. value)</th> <th>Applicable mounting dimension</th> </tr> </thead> <tbody> <tr> <td>10</td> <td>0.17</td> <td>15</td> </tr> <tr> <td>15</td> <td>0.25</td> <td>20</td> </tr> <tr> <td>20</td> <td>0.35</td> <td>25</td> </tr> <tr> <td>25</td> <td>0.42</td> <td>30</td> </tr> <tr> <td>30</td> <td>0.5</td> <td>above 35</td> </tr> </tbody> </table>			Measuring position from mounting surface	Shaft wobble (max. value)	Applicable mounting dimension	10	0.17	15	15	0.25	20	20	0.35	25	25	0.42	30	30	0.5	above 35	<table border="1"> <thead> <tr> <th>Distance from mounting surface to the tip of shaft</th> <th>Shaft wobble (max. value)</th> </tr> </thead> <tbody> <tr> <td>below 5</td> <td>0.5</td> </tr> <tr> <td>above 5 and below 10</td> <td>0.9</td> </tr> <tr> <td>above 10 and below 15</td> <td>1.2</td> </tr> </tbody> </table>			Distance from mounting surface to the tip of shaft	Shaft wobble (max. value)	below 5	0.5	above 5 and below 10	0.9	above 10 and below 15	1.2	<table border="1"> <thead> <tr> <th>Measuring position from mounting surface</th> <th>Shaft wobble (max. value)</th> <th>Applicable mounting dimension</th> </tr> </thead> <tbody> <tr> <td>10</td> <td>0.2</td> <td>15</td> </tr> <tr> <td>15</td> <td>0.3</td> <td>20</td> </tr> <tr> <td>20</td> <td>0.4</td> <td>25</td> </tr> </tbody> </table>			Measuring position from mounting surface	Shaft wobble (max. value)	Applicable mounting dimension	10	0.2	15	15	0.3	20	20	0.4	25	Unit:mm	
Measuring position from mounting surface	Shaft wobble (max. value)	Applicable mounting dimension																																														
10	0.17	15																																														
15	0.25	20																																														
20	0.35	25																																														
25	0.42	30																																														
30	0.5	above 35																																														
Distance from mounting surface to the tip of shaft	Shaft wobble (max. value)																																															
below 5	0.5																																															
above 5 and below 10	0.9																																															
above 10 and below 15	1.2																																															
Measuring position from mounting surface	Shaft wobble (max. value)	Applicable mounting dimension																																														
10	0.2	15																																														
15	0.3	20																																														
20	0.4	25																																														
Environmental performance	Cold	-40°C 500h	-20°C 96h	-40°C 96h	-20°C 96h		-40°C 96h																																									
	Dry heat	85°C 500h	85°C 96h																																													
	Damp heat	60°C, 90 to 95%RH 500h	40°C, 90 to 95%RH 96h																																													
Page	133	135	137	140	142	145																																										

Rotary Switches Soldering Conditions 148
 Rotary Switches Cautions 149

Example of Reflow Soldering Condition

1. Heating method: Double heating method with infrared heater.
2. Temperature measurement: Thermocouple $\phi 0.1$ to 0.2 CA (K) or CC (T) at soldering portion (copper foil surface). A heat resisting tape should be used for fixed measurement.
3. Temperature profile

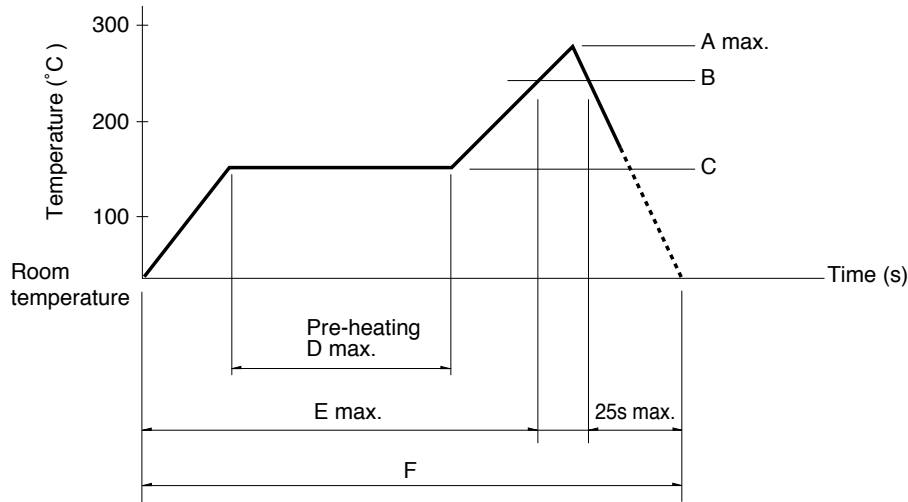

Series (Reflow type)	A (°C) 3s max.	B (°C)	C (°C)	D (s)	E (s)	F (s)
SRBQ	250	200	150±5	80 to 100	—	—

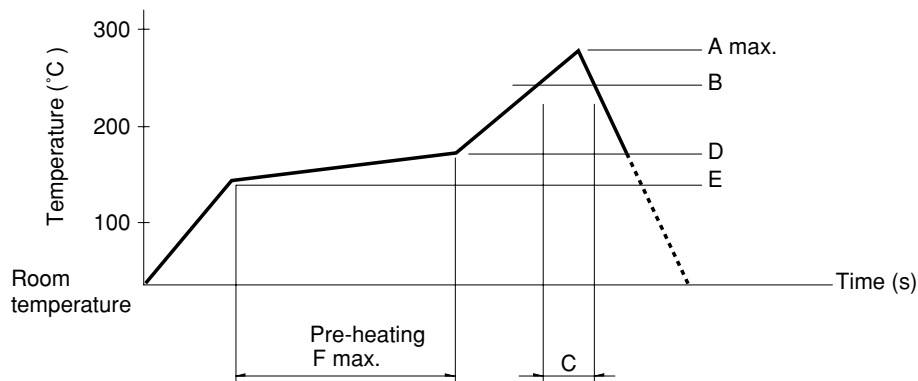

Series (Reflow type)	A (°C) 3s max.	B (°C)	C (s)	D (°C)	E (°C)	F (s)
SRBD	260	230	40	180	150	120

- Notes**
1. The condition mentioned above is the temperature on the mounting surface of a PC board. There are cases where the PC board's temperature greatly differs from that of the switch, depending on the PC board's material, size, thickness, etc. The above-stated conditions shall also apply to switch surface temperatures.
 2. Soldering conditions differ depending on reflow soldering machines. Prior verification of soldering condition is highly recommended.

Reference for Hand Soldering

Series	Soldering temperature	Soldering time
SRBQ, SRBM, SRBV, SRRM, SRRN	350±10°C	3+1/0s
SRBQ (Reflow type)	350±5°C	3s max.

Reference for Dip Soldering

(For PC board terminal types)

Series	Items		Dip soldering	
	Preheating temperature	Preheating time	Soldering temperature	Duration of immersion
SRBM	100°C max.	60s max.	260±5°C	5s max.
SRBV, SRRM, SRRN	—	—	260±5°C	10±1s
SRBQ	—	—	260±5°C	5±1s