

BFP420F

Low Noise Silicon Bipolar RF Transistor

Data Sheet

Revision 1.1, 2012-11-07

Edition 2012-11-07

**Published by
Infineon Technologies AG
81726 Munich, Germany**

**© 2013 Infineon Technologies AG
All Rights Reserved.**

Legal Disclaimer

The information given in this document shall in no event be regarded as a guarantee of conditions or characteristics. With respect to any examples or hints given herein, any typical values stated herein and/or any information regarding the application of the device, Infineon Technologies hereby disclaims any and all warranties and liabilities of any kind, including without limitation, warranties of non-infringement of intellectual property rights of any third party.

Information

For further information on technology, delivery terms and conditions and prices, please contact the nearest Infineon Technologies Office (www.infineon.com).

Warnings

Due to technical requirements, components may contain dangerous substances. For information on the types in question, please contact the nearest Infineon Technologies Office.

Infineon Technologies components may be used in life-support devices or systems only with the express written approval of Infineon Technologies, if a failure of such components can reasonably be expected to cause the failure of that life-support device or system or to affect the safety or effectiveness of that device or system. Life support devices or systems are intended to be implanted in the human body or to support and/or maintain and sustain and/or protect human life. If they fail, it is reasonable to assume that the health of the user or other persons may be endangered.

BFP420F, Low Noise Silicon Bipolar RF Transistor
Revision History: 2012-11-07, Revision 1.1
Previous Revision: Rev. 1.0

Page	Subjects (major changes since last revision)
	This datasheet replaces the revision from 2012-01-30. The product itself has not been changed and the device characteristics remain unchanged. Only the product description and information available in the datasheet has been expanded and updated.

Trademarks of Infineon Technologies AG

AURIX™, C166™, CanPAK™, CIPOS™, CIPURSE™, EconoPACK™, CoolMOS™, CoolSET™, CORECONTROL™, CROSSAVE™, DAVE™, DI-POL™, EasyPIM™, EconoBRIDGE™, EconoDUAL™, EconoPIM™, EconoPACK™, EiceDRIVER™, eupec™, FCOS™, HITFET™, HybridPACK™, I²RF™, ISOFACE™, IsoPACK™, MIPAQ™, ModSTACK™, my-d™, NovalithIC™, OptiMOS™, ORIGA™, POWERCODE™, PRIMARION™, PrimePACK™, PrimeSTACK™, PRO-SIL™, PROFET™, RASIC™, ReverSave™, SatRIC™, SIEGET™, SINDRION™, SIPMOS™, SmartLEWIS™, SOLID FLASH™, TEMPFET™, thinQ!™, TRENCHSTOP™, TriCore™.

Other Trademarks

Advance Design System™ (ADS) of Agilent Technologies, AMBA™, ARM™, MULTI-ICE™, KEIL™, PRIMECELL™, REALVIEW™, THUMB™, μVision™ of ARM Limited, UK. AUTOSAR™ is licensed by AUTOSAR development partnership. Bluetooth™ of Bluetooth SIG Inc. CAT-iq™ of DECT Forum. COLOSSUS™, FirstGPS™ of Trimble Navigation Ltd. EMV™ of EMVCo, LLC (Visa Holdings Inc.). EPCOS™ of Epcos AG. FLEXGO™ of Microsoft Corporation. FlexRay™ is licensed by FlexRay Consortium. HYPERTERMINAL™ of Hilgraeve Incorporated. IEC™ of Commission Electrotechnique Internationale. IrDA™ of Infrared Data Association Corporation. ISO™ of INTERNATIONAL ORGANIZATION FOR STANDARDIZATION. MATLAB™ of MathWorks, Inc. MAXIM™ of Maxim Integrated Products, Inc. MICROTEC™, NUCLEUS™ of Mentor Graphics Corporation. MIPI™ of MIPI Alliance, Inc. MIPS™ of MIPS Technologies, Inc., USA. muRata™ of MURATA MANUFACTURING CO., MICROWAVE OFFICE™ (MWO) of Applied Wave Research Inc., OmniVision™ of OmniVision Technologies, Inc. Openwave™ Openwave Systems Inc. RED HAT™ Red Hat, Inc. RFMD™ RF Micro Devices, Inc. SIRIUS™ of Sirius Satellite Radio Inc. SOLARIS™ of Sun Microsystems, Inc. SPANSION™ of Spansion LLC Ltd. Symbian™ of Symbian Software Limited. TAIYO YUDEN™ of Taiyo Yuden Co. TEAKLITE™ of CEVA, Inc. TEKTRONIX™ of Tektronix Inc. TOKO™ of TOKO KABUSHIKI KAISHA TA. UNIX™ of X/Open Company Limited. VERILOG™, PALLADIUM™ of Cadence Design Systems, Inc. VLYNQ™ of Texas Instruments Incorporated. VXWORKS™, WIND RIVER™ of WIND RIVER SYSTEMS, INC. ZETEX™ of Diodes Zetex Limited.

Last Trademarks Update 2011-11-11

Table of Contents

	Table of Contents	4
	List of Figures	5
	List of Tables	6
1	Product Brief	7
2	Features	8
3	Maximum Ratings	9
4	Thermal Characteristics	10
5	Electrical Characteristics	11
5.1	DC Characteristics	11
5.2	General AC Characteristics	11
5.3	Frequency Dependent AC Characteristics	12
5.4	Characteristic DC Diagrams	18
5.5	Characteristic AC Diagrams	21
6	Simulation Data	28
7	Package Information TSFP-4-1	29

List of Figures

Figure 4-1	Total Power Dissipation $P_{tot} = f(T_s)$	10
Figure 5-1	BFP420F Testing Circuit.	12
Figure 5-2	Collector Current vs. Collector Emitter Voltage $I_C = f(V_{CE})$, $I_B = \text{Parameter in } \mu\text{A}$	18
Figure 5-3	DC Current Gain $h_{FE} = f(I_C)$, $V_{CE} = 3 \text{ V}$	18
Figure 5-4	Collector Current vs. Base Emitter Voltage $I_C = f(V_{BE})$, $V_{CE} = 3 \text{ V}$	19
Figure 5-5	Base Current vs. Base Emitter Forward Voltage $I_B = f(V_{BE})$, $V_{CE} = 3 \text{ V}$	19
Figure 5-6	Base Current vs. Base Emitter Reverse Voltage $I_B = f(V_{EB})$, $V_{CE} = 3 \text{ V}$	20
Figure 5-7	Collector Emitter Breakdown Voltage $V_{CER} = f(R_{BE})$, $I_C = 1 \text{ mA}$	20
Figure 5-8	Transition Frequency $f_T = f(I_C)$, $f = 2 \text{ GHz}$, $V_{CE} = \text{Parameter in V}$	21
Figure 5-9	3rd Order Intercept Point $OIP_3 = f(I_C)$, $Z_S = Z_L = 50 \Omega$, V_{CE} , $f = \text{Parameters}$	21
Figure 5-10	3rd Order Intercept Point at output $OIP_3 \text{ [dBm]} = f(I_C, V_{CE})$, $Z_S = Z_L = 50 \Omega$, $f = 1900 \text{ MHz}$	22
Figure 5-11	Compression Point at output $OP_{1dB} \text{ [dBm]} = f(I_C, V_{CE})$, $Z_S = Z_L = 50 \Omega$, $f = 1900 \text{ MHz}$	22
Figure 5-12	Collector Base Capacitance $C_{CB} = f(V_{CB})$, $f = 1 \text{ MHz}$	23
Figure 5-13	Gain G_{ma} , G_{ms} , $ S_{21} ^2 = f(f)$, $V_{CE} = 3 \text{ V}$, $I_C = 15 \text{ mA}$	23
Figure 5-14	Maximum Power Gain $G_{max} = f(I_C)$, $V_{CE} = 3 \text{ V}$, $f = \text{Parameter in GHz}$	24
Figure 5-15	Maximum Power Gain $G_{max} = f(V_{CE})$, $I_C = 15 \text{ mA}$, $f = \text{Parameter in GHz}$	24
Figure 5-16	Input Matching $S_{11} = f(f)$, $V_{CE} = 3 \text{ V}$, $I_C = 4 / 15 / 40 \text{ mA}$	25
Figure 5-17	Source Impedance for Minimum Noise Figure $Z_{opt} = f(f)$, $V_{CE} = 3 \text{ V}$, $I_C = 4 / 15 \text{ mA}$	25
Figure 5-18	Output Matching $S_{22} = f(f)$, $V_{CE} = 3 \text{ V}$, $I_C = 4 / 15 / 40 \text{ mA}$	26
Figure 5-19	Noise Figure $NF_{min} = f(f)$, $V_{CE} = 3 \text{ V}$, $I_C = 4 / 16 \text{ mA}$, $Z_S = Z_{opt}$	26
Figure 5-20	Noise Figure $NF_{min} = f(I_C)$, $V_{CE} = 3 \text{ V}$, $Z_S = Z_{opt}$, $f = \text{Parameter in GHz}$	27
Figure 5-21	Noise Figure $NF_{50} = f(I_C)$, $V_{CE} = 3 \text{ V}$, $Z_S = 50 \Omega$, $f = \text{Parameter in GHz}$	27
Figure 7-1	Package Outline	29
Figure 7-2	Package Footprint	29
Figure 7-3	Marking Description (Marking BFP420F: AMs)	29
Figure 7-4	Tape Dimensions	29

List of Tables

Table 3-1	Maximum Ratings at $T_A = 25\text{ °C}$ (unless otherwise specified)	9
Table 4-1	Thermal Resistance	10
Table 5-1	DC Characteristics at $T_A = 25\text{ °C}$	11
Table 5-2	General AC Characteristics at $T_A = 25\text{ °C}$	11
Table 5-3	AC Characteristics, $f = 150\text{ MHz}$	12
Table 5-4	AC Characteristics, $f = 450\text{ MHz}$	13
Table 5-5	AC Characteristics, $f = 900\text{ MHz}$	13
Table 5-6	AC Characteristics, $f = 1500\text{ MHz}$	14
Table 5-7	AC Characteristics, $f = 1900\text{ MHz}$	15
Table 5-8	AC Characteristics, $f = 2400\text{ MHz}$	15
Table 5-9	AC Characteristics, $f = 3500\text{ MHz}$	16
Table 5-10	AC Characteristics, $f = 5500\text{ MHz}$	17

1 Product Brief

The BFP420F is a low noise wideband NPN bipolar RF transistor. The collector design supports voltages up to $V_{\text{CEO}} = 4.5 \text{ V}$ and currents up to $I_{\text{C}} = 60 \text{ mA}$. The device is especially suited for mobile applications in which low power consumption is a key requirement. The typical transition frequency is approximately 25 GHz, hence the device offers high power gain at frequencies up to 4.5 GHz in amplifier applications. The device is housed in a thin small flat plastic package with visible leads.

2 Features

- General purpose low noise NPN bipolar RF transistor
- Based on Infineon’s reliable very high volume 25 GHz silicon bipolar technology
- 0.95 dB minimum noise figure typical at 900 MHz, 3 V, 4 mA
- 16.5 dB maximum gain (G_{ma}) typical at 2.4 GHz, 3 V, 15 mA
- 28 dBm OIP_3 typical at 2.4 GHz, 4 V, 40 mA
- 16.5 dBm OP_{1dB} typical at 2.4 GHz, 4 V, 40 mA
- Popular in discrete oscillators
- Thin, small, flat, Pb-free (RoHS compliant) and Halogen-free package with visible leads
- Qualification report according to AEC-Q101 available

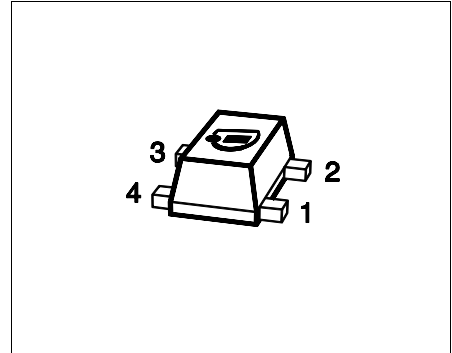

Applications

As Low Noise Amplifier (LNA) in

- Satellite communication systems: Navigation systems (GPS, Glonass), satellite radio (SDARs, DAB)
- Multimedia applications such as mobile/portable TV, CATV, FM Radio
- ISM applications like RKE, AMR and Zigbee, as well as for emerging wireless applications

As discrete active mixer in RF Frontends

As active device in discrete oscillators

Attention: ESD (Electrostatic discharge) sensitive device, observe handling precautions

Product Name	Package	Pin Configuration				Marking
BFP420F	TSFP-4-1	1 = B	2 = E	3 = C	4 = E	AMs

3 Maximum Ratings

Table 3-1 Maximum Ratings at $T_A = 25\text{ °C}$ (unless otherwise specified)

Parameter	Symbol	Values		Unit	Note / Test Condition
		Min.	Max.		
Collector emitter voltage	V_{CEO}	– –	4.5 4.1	V	Open base $T_A = 25\text{ °C}$ $T_A = -55\text{ °C}$
Collector base voltage	V_{CBO}	–	15	V	Open emitter
Collector emitter voltage	V_{CES}	–	15	V	E-B short circuited
Emitter base voltage	V_{EBO}	–	1.5	V	Open collector
Base current	I_B	–	9	mA	–
Collector current	I_C	–	60	mA	–
Total power dissipation ¹⁾	P_{tot}	–	210	mW	$T_S \leq 100\text{ °C}$
Junction temperature	T_J	–	150	°C	–
Storage temperature	T_{Stg}	-55	150	°C	–

1) T_S is the soldering point temperature. T_S is measured on the emitter lead at the soldering point of the pcb.

Attention: Stresses above the max. values listed here may cause permanent damage to the device. Exposure to absolute maximum rating conditions for extended periods may affect device reliability. Maximum ratings are absolute ratings; exceeding only one of these values may cause irreversible damage to the integrated circuit.

4 Thermal Characteristics

Table 4-1 Thermal Resistance

Parameter	Symbol	Values			Unit	Note / Test Condition
		Min.	Typ.	Max.		
Junction - soldering point ¹⁾	R_{thJS}	–	240	–	K/W	–

1) For the definition of R_{thJS} please refer to Application Note AN077 (Thermal Resistance Calculation)

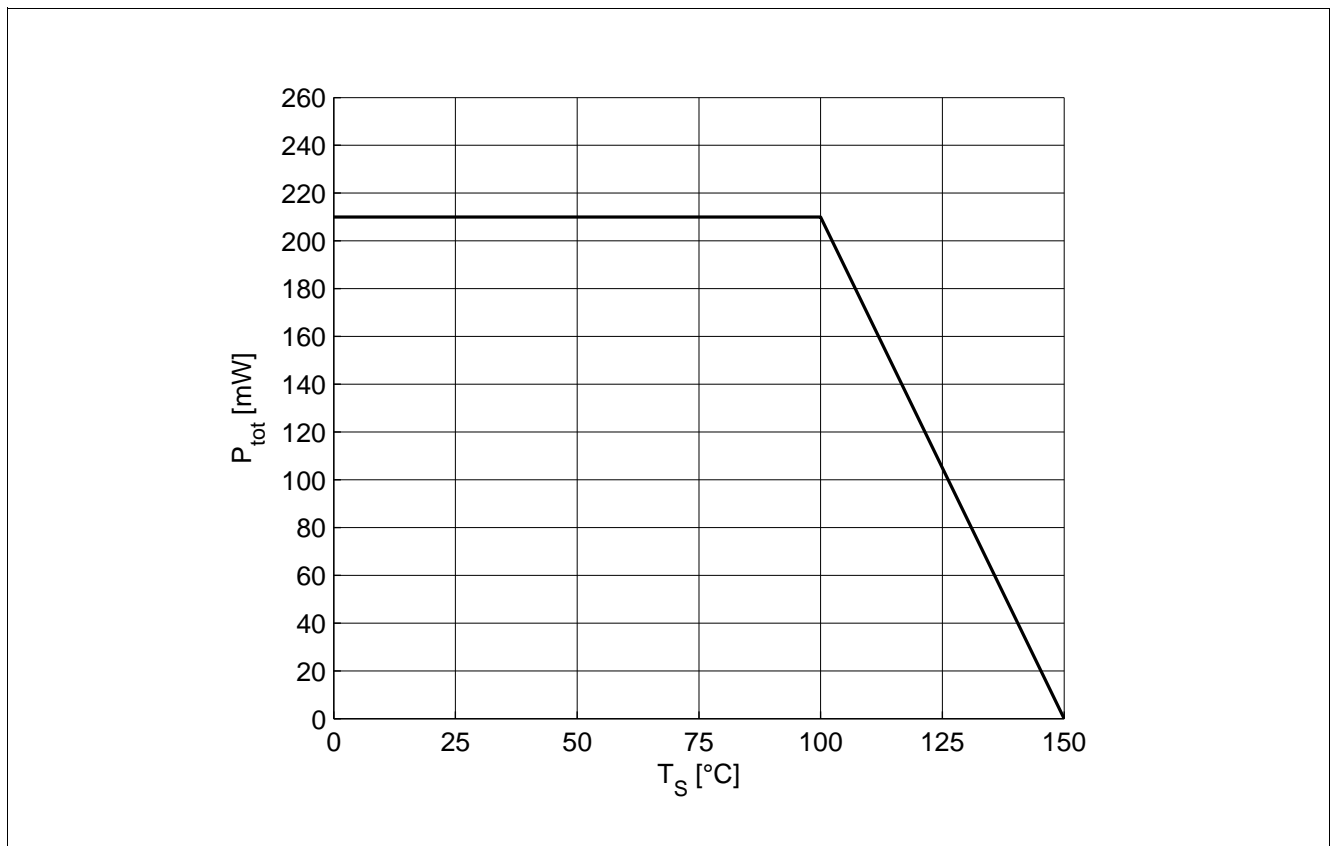

Figure 4-1 Total Power Dissipation $P_{tot} = f(T_s)$

5 Electrical Characteristics

5.1 DC Characteristics

Table 5-1 DC Characteristics at $T_A = 25\text{ °C}$

Parameter	Symbol	Values			Unit	Note / Test Condition
		Min.	Typ.	Max.		
Collector emitter breakdown voltage	$V_{(BR)CEO}$	4.5	5.5	–	V	$I_C = 1\text{ mA}$, $I_B = 0$ Open base
Collector emitter leakage current	I_{CES}	–	–	10	μA	$V_{CE} = 15\text{ V}$, $V_{BE} = 0$ $V_{CE} = 3\text{ V}$, $V_{BE} = 0$ E-B short circuited
		–	1	30	nA	
Collector base leakage current	I_{CBO}	–	1	30	nA	$V_{CB} = 3\text{ V}$, $I_E = 0$ Open emitter
Emitter base leakage current	I_{EBO}	–	10	100	nA	$V_{EB} = 0.5\text{ V}$, $I_C = 0$ Open collector
DC current gain	h_{FE}	60	95	130		$V_{CE} = 4\text{ V}$, $I_C = 5\text{ mA}$ Pulse measured

5.2 General AC Characteristics

Table 5-2 General AC Characteristics at $T_A = 25\text{ °C}$

Parameter	Symbol	Values			Unit	Note / Test Condition
		Min.	Typ.	Max.		
Transition frequency	f_T	18	25	–	GHz	$V_{CE} = 3\text{ V}$, $I_C = 30\text{ mA}$ $f = 2\text{ GHz}$
Collector base capacitance	C_{CB}	–	0.15	0.3	pF	$V_{CB} = 2\text{ V}$, $V_{BE} = 0$ $f = 1\text{ MHz}$ Emitter grounded
Collector emitter capacitance	C_{CE}	–	0.46	–	pF	$V_{CE} = 2\text{ V}$, $V_{BE} = 0$ $f = 1\text{ MHz}$ Base grounded
Emitter base capacitance	C_{EB}	–	0.55	–	pF	$V_{EB} = 0.5\text{ V}$, $V_{CB} = 0$ $f = 1\text{ MHz}$ Collector grounded

5.3 Frequency Dependent AC Characteristics

Measurement setup is a test fixture with Bias T's in a 50 Ω system, $T_A = 25\text{ °C}$

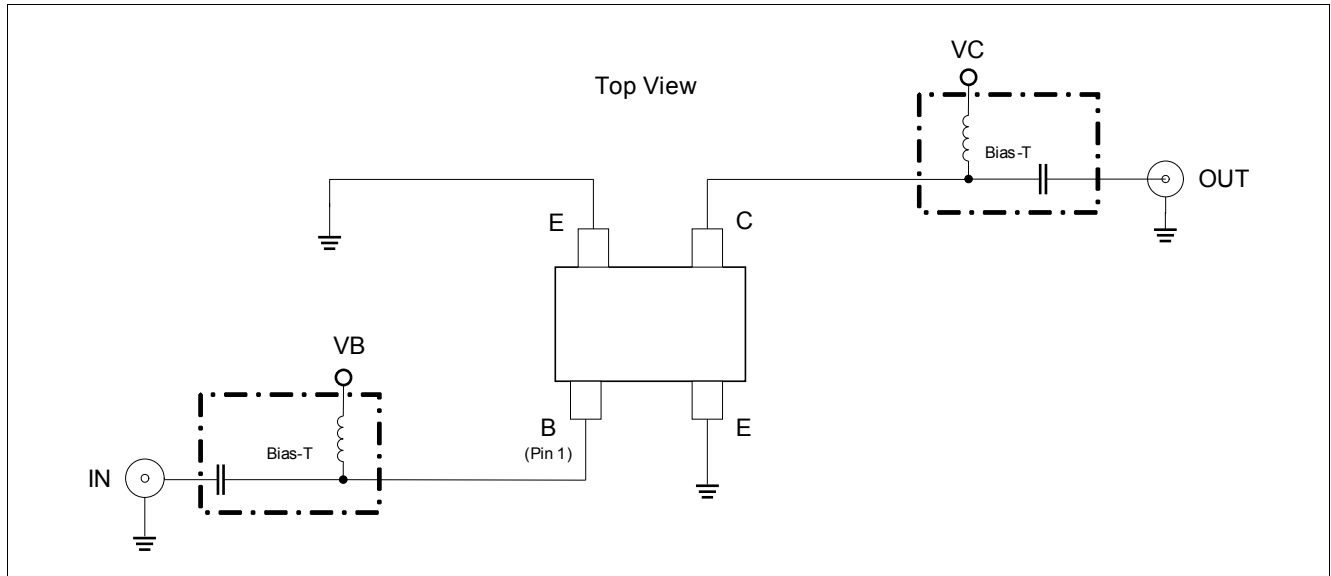

Figure 5-1 BFP420F Testing Circuit

Table 5-3 AC Characteristics, $f = 150\text{ MHz}$

Parameter	Symbol	Values			Unit	Note / Test Condition
		Min.	Typ.	Max.		
Maximum Power Gain					dB	$Z_S = Z_{SoptG}$, $Z_L = Z_{LoptG}$
@ low noise operating point	G_{ms}	–	30	–		$V_{CE} = 3\text{ V}$, $I_C = 4\text{ mA}$
@ recommended trade off oper. point	G_{ms}	–	34.5	–		$V_{CE} = 3\text{ V}$, $I_C = 15\text{ mA}$
@ max. linearity operating point	G_{ms}	–	37	–		$V_{CE} = 4\text{ V}$, $I_C = 40\text{ mA}$
Transducer Gain					dB	$Z_S = Z_L = 50\text{ }\Omega$
@ low noise operating point	S_{21}	–	22	–		$V_{CE} = 3\text{ V}$, $I_C = 4\text{ mA}$
@ recommended trade off oper. point	S_{21}	–	30	–		$V_{CE} = 3\text{ V}$, $I_C = 15\text{ mA}$
@ max. linearity operating point	S_{21}	–	33	–		$V_{CE} = 4\text{ V}$, $I_C = 40\text{ mA}$
Noise Figure					dB	$Z_S = Z_{SoptN}$
@ low noise operating point						$V_{CE} = 3\text{ V}$, $I_C = 4\text{ mA}$
Minimum noise figure	NF_{min}	–	0.9	–		
Associated gain	G_{ass}	–	24	–		
@ recommended trade off oper. point						$V_{CE} = 3\text{ V}$, $I_C = 15\text{ mA}$
Minimum noise figure	NF_{min}	–	1.4	–		
Associated gain	G_{ass}	–	29	–		
Linearity					dB	$Z_S = Z_L = 50\text{ }\Omega$
@ recommended trade off oper. point						$V_{CE} = 3\text{ V}$, $I_C = 15\text{ mA}$
3rd order intercept point at output	OIP_3	–	21	–		
1 dB gain compression point at output	OP_{1dB}	–	7	–		
@ max. linearity operating point						$V_{CE} = 4\text{ V}$, $I_C = 40\text{ mA}$
3rd order intercept point at output	OIP_3	–	25	–		
1 dB gain compression point at output	OP_{1dB}	–	15.5	–		

Electrical Characteristics
Table 5-4 AC Characteristics, $f = 450$ MHz

Parameter	Symbol	Values			Unit	Note / Test Condition
		Min.	Typ.	Max.		
Maximum Power Gain					dB	$Z_S = Z_{SoptG}, Z_L = Z_{LoptG}$ $V_{CE} = 3\text{ V}, I_C = 4\text{ mA}$ $V_{CE} = 3\text{ V}, I_C = 15\text{ mA}$ $V_{CE} = 4\text{ V}, I_C = 40\text{ mA}$
@ low noise operating point	G_{ms}	–	25	–		
@ recommended trade off oper. point	G_{ms}	–	29	–		
@ max. linearity operating point	G_{ms}	–	31	–		
Transducer Gain					dB	$Z_S = Z_L = 50\ \Omega$ $V_{CE} = 3\text{ V}, I_C = 4\text{ mA}$ $V_{CE} = 3\text{ V}, I_C = 15\text{ mA}$ $V_{CE} = 4\text{ V}, I_C = 40\text{ mA}$
@ low noise operating point	S_{21}	–	21	–		
@ recommended trade off oper. point	S_{21}	–	27	–		
@ max. linearity operating point	S_{21}	–	28.5	–		
Noise Figure					dB	$Z_S = Z_{SoptN}$ $V_{CE} = 3\text{ V}, I_C = 4\text{ mA}$ $V_{CE} = 3\text{ V}, I_C = 15\text{ mA}$
@ low noise operating point						
Minimum noise figure	NF_{min}	–	0.9	–		
Associated gain	G_{ass}	–	22.5	–		
@ recommended trade off oper. point						
Minimum noise figure	NF_{min}	–	1.4	–		
Associated gain	G_{ass}	–	27	–		
Linearity					dB	$Z_S = Z_L = 50\ \Omega$ $V_{CE} = 3\text{ V}, I_C = 15\text{ mA}$ $V_{CE} = 4\text{ V}, I_C = 40\text{ mA}$
@ recommended trade off oper. point						
3rd order intercept point at output	OIP_3	–	21.5	–		
1 dB gain compression point at output	OP_{1dB}	–	8	–		
@ max. linearity operating point						
3rd order intercept point at output	OIP_3	–	26.5	–		
1 dB gain compression point at output	OP_{1dB}	–	16.5	–		

Table 5-5 AC Characteristics, $f = 900$ MHz

Parameter	Symbol	Values			Unit	Note / Test Condition
		Min.	Typ.	Max.		
Maximum Power Gain					dB	$Z_S = Z_{SoptG}, Z_L = Z_{LoptG}$ $V_{CE} = 3\text{ V}, I_C = 4\text{ mA}$ $V_{CE} = 3\text{ V}, I_C = 15\text{ mA}$ $V_{CE} = 4\text{ V}, I_C = 40\text{ mA}$
@ low noise operating point	G_{ms}	–	22	–		
@ recommended trade off oper. point	G_{ms}	–	25	–		
@ max. linearity operating point	G_{ms}	–	26.5	–		
Transducer Gain					dB	$Z_S = Z_L = 50\ \Omega$ $V_{CE} = 3\text{ V}, I_C = 4\text{ mA}$ $V_{CE} = 3\text{ V}, I_C = 15\text{ mA}$ $V_{CE} = 4\text{ V}, I_C = 40\text{ mA}$
@ low noise operating point	S_{21}	–	19	–		
@ recommended trade off oper. point	S_{21}	–	23	–		
@ max. linearity operating point	S_{21}	–	24	–		

Electrical Characteristics
Table 5-5 AC Characteristics, $f = 900$ MHz (cont'd)

Parameter	Symbol	Values			Unit	Note / Test Condition
		Min.	Typ.	Max.		
Noise Figure					dB	$Z_S = Z_{SoptN}$ $V_{CE} = 3$ V, $I_C = 4$ mA $V_{CE} = 3$ V, $I_C = 15$ mA
@ low noise operating point						
Minimum noise figure	NF_{min}	–	0.95	–		
Associated gain	G_{ass}	–	20	–		
@ recommended trade off oper. point						
Minimum noise figure	NF_{min}	–	1.4	–		
Associated gain	G_{ass}	–	23	–		
Linearity					dB	$Z_S = Z_L = 50$ Ω $V_{CE} = 3$ V, $I_C = 15$ mA $V_{CE} = 4$ V, $I_C = 40$ mA
@ recommended trade off oper. point						
3rd order intercept point at output	OIP_3	–	23.5	–		
1 dB gain compression point at output	OP_{1dB}	–	8	–		
@ max. linearity operating point						
3rd order intercept point at output	OIP_3	–	27.5	–		
1 dB gain compression point at output	OP_{1dB}	–	17	–		

Table 5-6 AC Characteristics, $f = 1500$ MHz

Parameter	Symbol	Values			Unit	Note / Test Condition
		Min.	Typ.	Max.		
Maximum Power Gain					dB	$Z_S = Z_{SoptG}$, $Z_L = Z_{LoptG}$ $V_{CE} = 3$ V, $I_C = 4$ mA $V_{CE} = 3$ V, $I_C = 15$ mA $V_{CE} = 4$ V, $I_C = 40$ mA
@ low noise operating point	G_{ms}	–	19	–		
@ recommended trade off oper. point	G_{ms}	–	22	–		
@ max. linearity operating point	G_{ma}	–	22	–		
Transducer Gain					dB	$Z_S = Z_L = 50$ Ω $V_{CE} = 3$ V, $I_C = 4$ mA $V_{CE} = 3$ V, $I_C = 15$ mA $V_{CE} = 4$ V, $I_C = 40$ mA
@ low noise operating point	S_{21}	–	16	–		
@ recommended trade off oper. point	S_{21}	–	19	–		
@ max. linearity operating point	S_{21}	–	19,5	–		
Noise Figure					dB	$Z_S = Z_{SoptN}$ $V_{CE} = 3$ V, $I_C = 4$ mA $V_{CE} = 3$ V, $I_C = 15$ mA
@ low noise operating point						
Minimum noise figure	NF_{min}	–	1	–		
Associated gain	G_{ass}	–	16.5	–		
@ recommended trade off oper. point						
Minimum noise figure	NF_{min}	–	1.5	–		
Associated gain	G_{ass}	–	19	–		
Linearity					dB	$Z_S = Z_L = 50$ Ω $V_{CE} = 3$ V, $I_C = 15$ mA $V_{CE} = 4$ V, $I_C = 40$ mA
@ recommended trade off oper. point						
3rd order intercept point at output	OIP_3	–	22.5	–		
1 dB gain compression point at output	OP_{1dB}	–	7	–		
@ max. linearity operating point						
3rd order intercept point at output	OIP_3	–	27.5	–		
1 dB gain compression point at output	OP_{1dB}	–	16	–		

Electrical Characteristics
Table 5-7 AC Characteristics, $f = 1900$ MHz

Parameter	Symbol	Values			Unit	Note / Test Condition
		Min.	Typ.	Max.		
Maximum Power Gain					dB	$Z_S = Z_{SoptG}, Z_L = Z_{LoptG}$ $V_{CE} = 3\text{ V}, I_C = 4\text{ mA}$ $V_{CE} = 3\text{ V}, I_C = 15\text{ mA}$ $V_{CE} = 4\text{ V}, I_C = 40\text{ mA}$
@ low noise operating point	G_{ms}	–	18	–		
@ recommended trade off oper. point	G_{ma}	–	19.5	–		
@ max. linearity operating point	G_{ma}	–	19	–		
Transducer Gain					dB	$Z_S = Z_L = 50\ \Omega$ $V_{CE} = 3\text{ V}, I_C = 4\text{ mA}$ $V_{CE} = 3\text{ V}, I_C = 15\text{ mA}$ $V_{CE} = 4\text{ V}, I_C = 40\text{ mA}$
@ low noise operating point	S_{21}	–	14	–		
@ recommended trade off oper. point	S_{21}	–	16.5	–		
@ max. linearity operating point	S_{21}	–	17	–		
Noise Figure					dB	$Z_S = Z_{SoptN}$ $V_{CE} = 3\text{ V}, I_C = 4\text{ mA}$ $V_{CE} = 3\text{ V}, I_C = 15\text{ mA}$
@ low noise operating point						
Minimum noise figure	NF_{min}	–	1.1	–		
Associated gain	G_{ass}	–	15	–		
@ recommended trade off oper. point						
Minimum noise figure	NF_{min}	–	1.5	–		
Associated gain	G_{ass}	–	17	–		
Linearity					dB	$Z_S = Z_L = 50\ \Omega$ $V_{CE} = 3\text{ V}, I_C = 15\text{ mA}$ $V_{CE} = 4\text{ V}, I_C = 40\text{ mA}$
@ recommended trade off oper. point						
3rd order intercept point at output	OIP_3	–	24	–		
1 dB gain compression point at output	OP_{1dB}	–	9	–		
@ max. linearity operating point						
3rd order intercept point at output	OIP_3	–	28	–		
1 dB gain compression point at output	OP_{1dB}	–	17	–		

Table 5-8 AC Characteristics, $f = 2400$ MHz

Parameter	Symbol	Values			Unit	Note / Test Condition
		Min.	Typ.	Max.		
Maximum Power Gain					dB	$Z_S = Z_{SoptG}, Z_L = Z_{LoptG}$ $V_{CE} = 3\text{ V}, I_C = 4\text{ mA}$ $V_{CE} = 3\text{ V}, I_C = 15\text{ mA}$ $V_{CE} = 4\text{ V}, I_C = 40\text{ mA}$
@ low noise operating point	G_{ms}	–	16.5	–		
@ recommended trade off oper. point	G_{ma}	–	16.5	–		
@ max. linearity operating point	G_{ma}	–	16.5	–		
Transducer Gain					dB	$Z_S = Z_L = 50\ \Omega$ $V_{CE} = 3\text{ V}, I_C = 4\text{ mA}$ $V_{CE} = 3\text{ V}, I_C = 15\text{ mA}$ $V_{CE} = 4\text{ V}, I_C = 40\text{ mA}$
@ low noise operating point	S_{21}	–	12	–		
@ recommended trade off oper. point	S_{21}	–	14.5	–		
@ max. linearity operating point	S_{21}	–	15	–		

Electrical Characteristics
Table 5-8 AC Characteristics, $f = 2400$ MHz (cont'd)

Parameter	Symbol	Values			Unit	Note / Test Condition
		Min.	Typ.	Max.		
Noise Figure					dB	$Z_S = Z_{SoptN}$ $V_{CE} = 3\text{ V}, I_C = 4\text{ mA}$ $V_{CE} = 3\text{ V}, I_C = 15\text{ mA}$
@ low noise operating point						
Minimum noise figure	NF_{min}	–	1.2	–		
Associated gain	G_{ass}	–	12.5	–		
@ recommended trade off oper. point						
Minimum noise figure	NF_{min}	–	1.6	–		
Associated gain	G_{ass}	–	15	–		
Linearity					dB	$Z_S = Z_L = 50\ \Omega$ $V_{CE} = 3\text{ V}, I_C = 15\text{ mA}$ $V_{CE} = 4\text{ V}, I_C = 40\text{ mA}$
@ recommended trade off oper. point						
3rd order intercept point at output	OIP_3	–	24.5	–		
1 dB gain compression point at output	OP_{1dB}	–	8.5	–		
@ max. linearity operating point						
3rd order intercept point at output	OIP_3	–	28	–		
1 dB gain compression point at output	OP_{1dB}	–	16.5	–		

Table 5-9 AC Characteristics, $f = 3500$ MHz

Parameter	Symbol	Values			Unit	Note / Test Condition
		Min.	Typ.	Max.		
Maximum Power Gain					dB	$Z_S = Z_{SoptG}, Z_L = Z_{LoptG}$ $V_{CE} = 3\text{ V}, I_C = 4\text{ mA}$ $V_{CE} = 3\text{ V}, I_C = 15\text{ mA}$ $V_{CE} = 4\text{ V}, I_C = 40\text{ mA}$
@ low noise operating point	G_{ma}	–	11.5	–		
@ recommended trade off oper. point	G_{ma}	–	12.5	–		
@ max. linearity operating point	G_{ma}	–	13	–		
Transducer Gain					dB	$Z_S = Z_L = 50\ \Omega$ $V_{CE} = 3\text{ V}, I_C = 4\text{ mA}$ $V_{CE} = 3\text{ V}, I_C = 15\text{ mA}$ $V_{CE} = 4\text{ V}, I_C = 40\text{ mA}$
@ low noise operating point	S_{21}	–	9	–		
@ recommended trade off oper. point	S_{21}	–	11	–		
@ max. linearity operating point	S_{21}	–	11.5	–		
Noise Figure					dB	$Z_S = Z_{SoptN}$ $V_{CE} = 3\text{ V}, I_C = 4\text{ mA}$ $V_{CE} = 3\text{ V}, I_C = 15\text{ mA}$
@ low noise operating point						
Minimum noise figure	NF_{min}	–	1.6	–		
Associated gain	G_{ass}	–	10	–		
@ recommended trade off oper. point						
Minimum noise figure	NF_{min}	–	1.8	–		
Associated gain	G_{ass}	–	11.5	–		
Linearity					dB	$Z_S = Z_L = 50\ \Omega$ $V_{CE} = 3\text{ V}, I_C = 15\text{ mA}$ $V_{CE} = 4\text{ V}, I_C = 40\text{ mA}$
@ recommended trade off oper. point						
3rd order intercept point at output	OIP_3	–	22	–		
1 dB gain compression point at output	OP_{1dB}	–	8	–		
@ max. linearity operating point						
3rd order intercept point at output	OIP_3	–	26	–		
1 dB gain compression point at output	OP_{1dB}	–	17	–		

Table 5-10 AC Characteristics, $f = 5500$ MHz

Parameter	Symbol	Values			Unit	Note / Test Condition
		Min.	Typ.	Max.		
Maximum Power Gain					dB	$Z_S = Z_{SoptG}, Z_L = Z_{LoptG}$ $V_{CE} = 3$ V, $I_C = 4$ mA $V_{CE} = 3$ V, $I_C = 15$ mA $V_{CE} = 4$ V, $I_C = 40$ mA
@ low noise operating point	G_{ma}	–	7.5	–		
@ recommended trade off oper. point	G_{ma}	–	8.5	–		
@ max. linearity operating point	G_{ma}	–	9	–		
Transducer Gain					dB	$Z_S = Z_L = 50$ Ω $V_{CE} = 3$ V, $I_C = 4$ mA $V_{CE} = 3$ V, $I_C = 15$ mA $V_{CE} = 4$ V, $I_C = 40$ mA
@ low noise operating point	S_{21}	–	5.5	–		
@ recommended trade off oper. point	S_{21}	–	7	–		
@ max. linearity operating point	S_{21}	–	8	–		
Noise Figure					dB	$Z_S = Z_{SoptN}$ $V_{CE} = 3$ V, $I_C = 4$ mA $V_{CE} = 3$ V, $I_C = 15$ mA
@ low noise operating point						
Minimum noise figure	NF_{min}	–	2.2	–		
Associated gain	G_{ass}	–	5	–		
@ recommended trade off oper. point						
Minimum noise figure	NF_{min}	–	2.3	–		
Associated gain	G_{ass}	–	8	–		
Linearity					dB	$Z_S = Z_L = 50$ Ω $V_{CE} = 3$ V, $I_C = 15$ mA $V_{CE} = 4$ V, $I_C = 40$ mA
@ recommended trade off oper. point						
3rd order intercept point at output	OIP_3	–	22	–		
1 dB gain compression point at output	OP_{1dB}	–	8.5	–		
@ max. linearity operating point						
3rd order intercept point at output	OIP_3	–	26	–		
1 dB gain compression point at output	OP_{1dB}	–	17	–		

Notes

- $G_{ms} = |S_{21} / S_{12}|$ for $k < 1$; $G_{ma} = |S_{21} / S_{12}|(k - (k^2 - 1)^{1/2})$ for $k > 1$
- In order to get the NF_{min} values stated in this chapter the test fixture losses have been subtracted from all measured results.
- OIP_3 value depends on termination of all intermodulation frequency components. Termination used for this measurement is 50 Ω from 0.2 MHz to 12 GHz.

5.4 Characteristic DC Diagrams

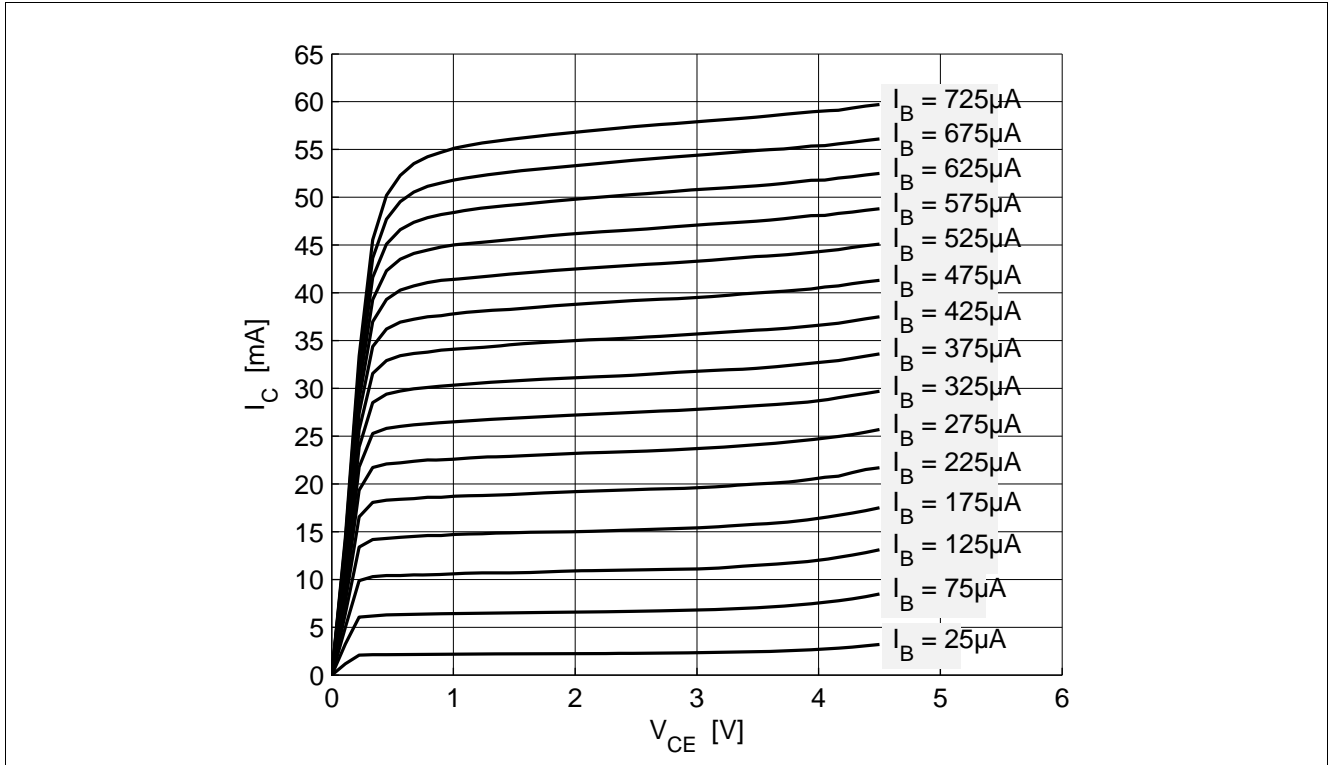

Figure 5-2 Collector Current vs. Collector Emitter Voltage $I_C = f(V_{CE})$, $I_B = \text{Parameter in } \mu\text{A}$

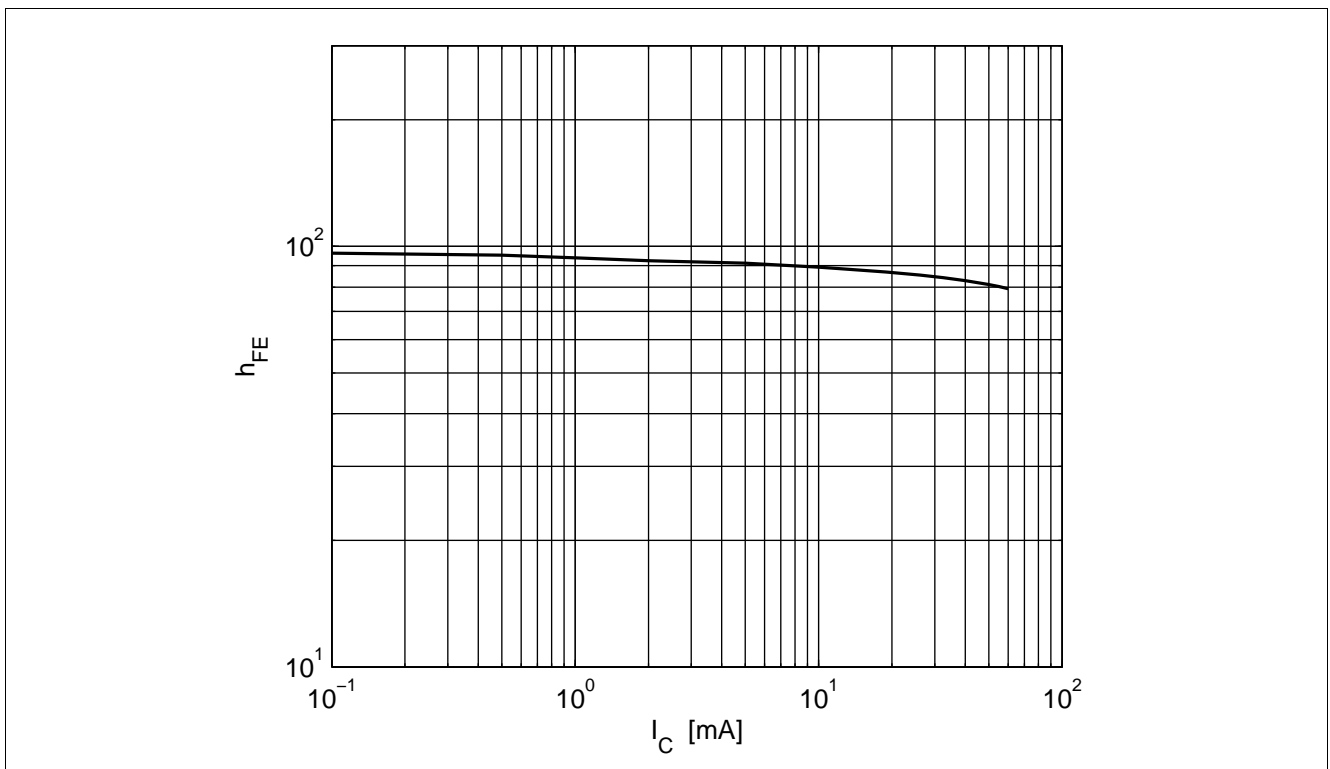

Figure 5-3 DC Current Gain $h_{FE} = f(I_C)$, $V_{CE} = 3 \text{ V}$

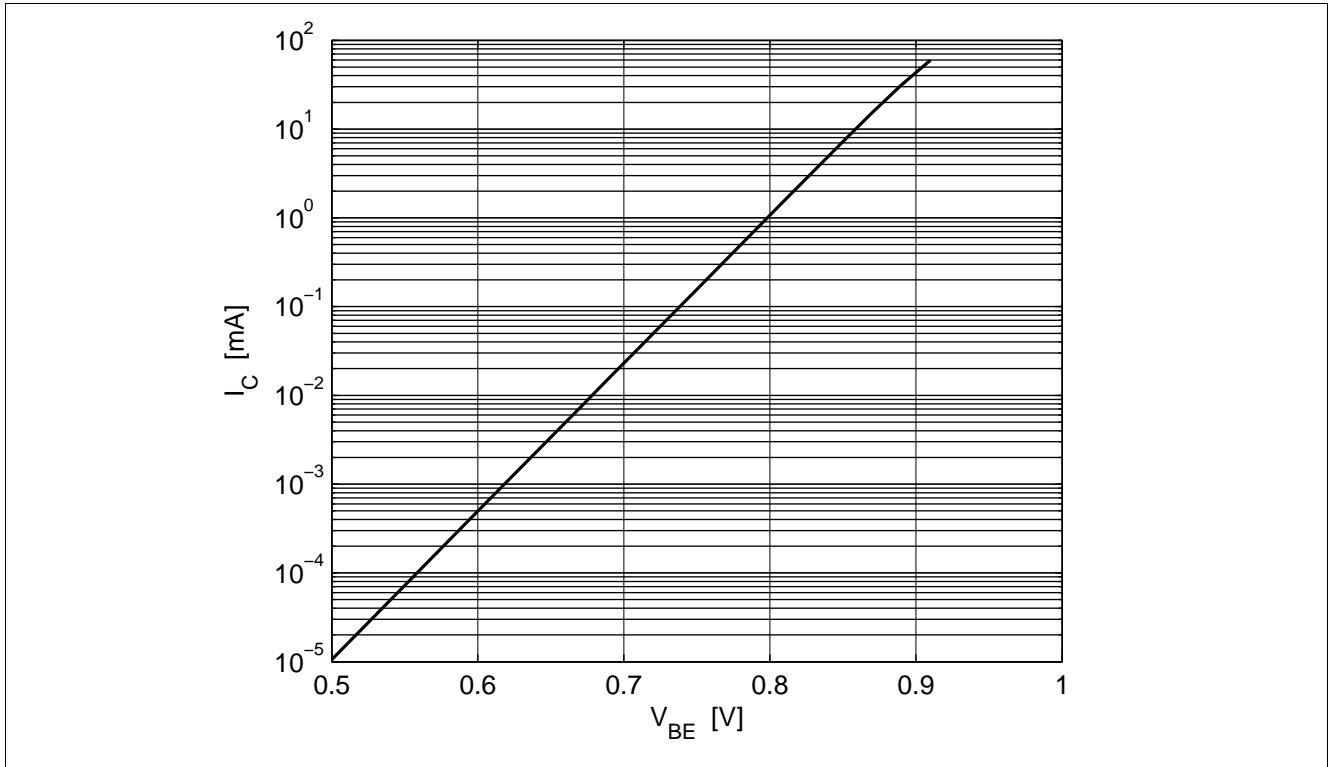

Figure 5-4 Collector Current vs. Base Emitter Voltage $I_C = f(V_{BE})$, $V_{CE} = 3\text{ V}$

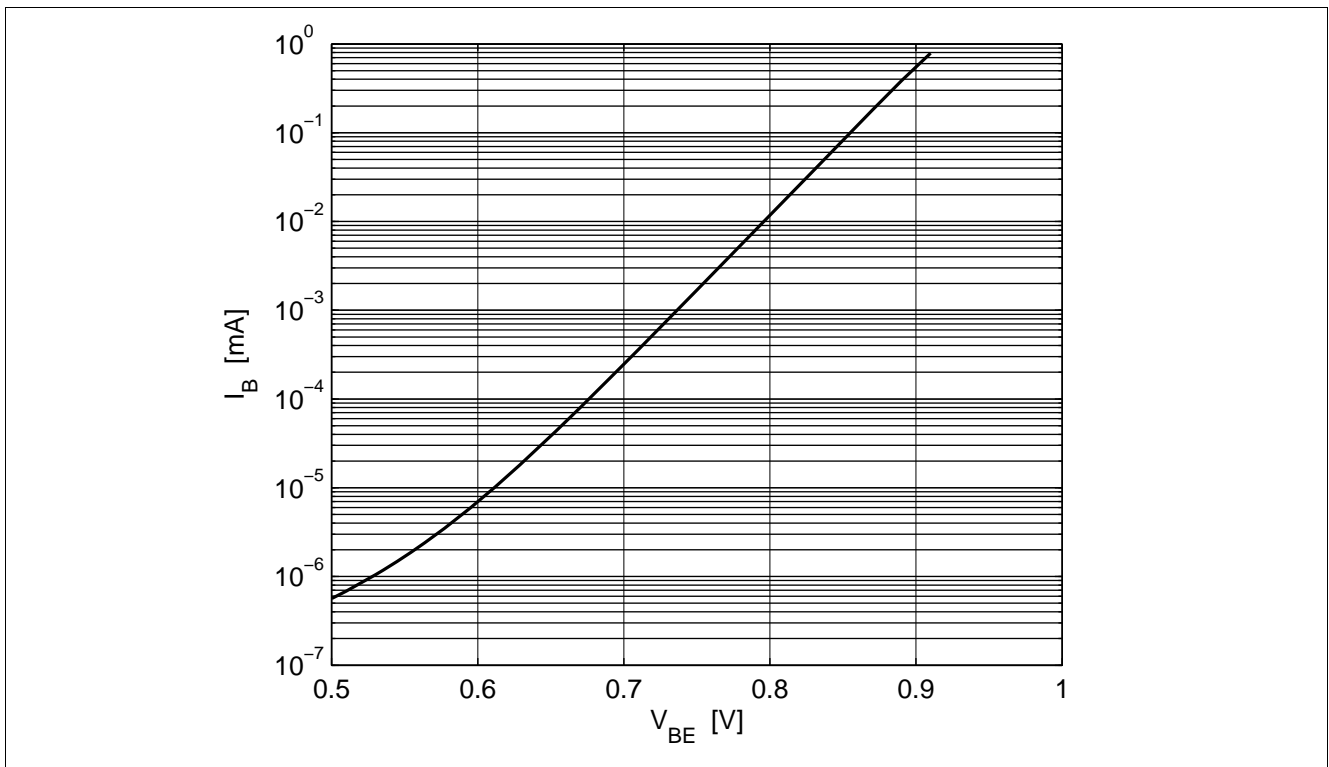

Figure 5-5 Base Current vs. Base Emitter Forward Voltage $I_B = f(V_{BE})$, $V_{CE} = 3\text{ V}$

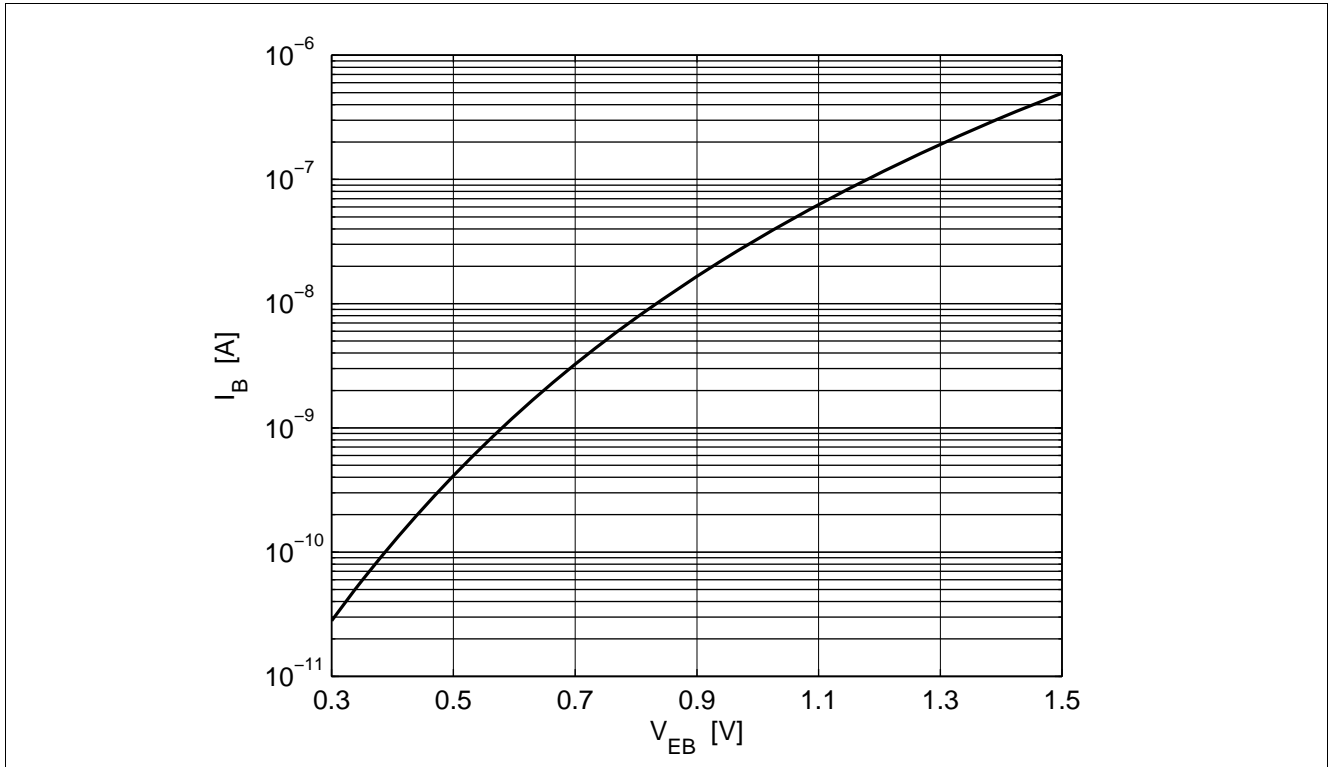

Figure 5-6 Base Current vs. Base Emitter Reverse Voltage $I_B = f(V_{EB})$, $V_{CE} = 3\text{ V}$

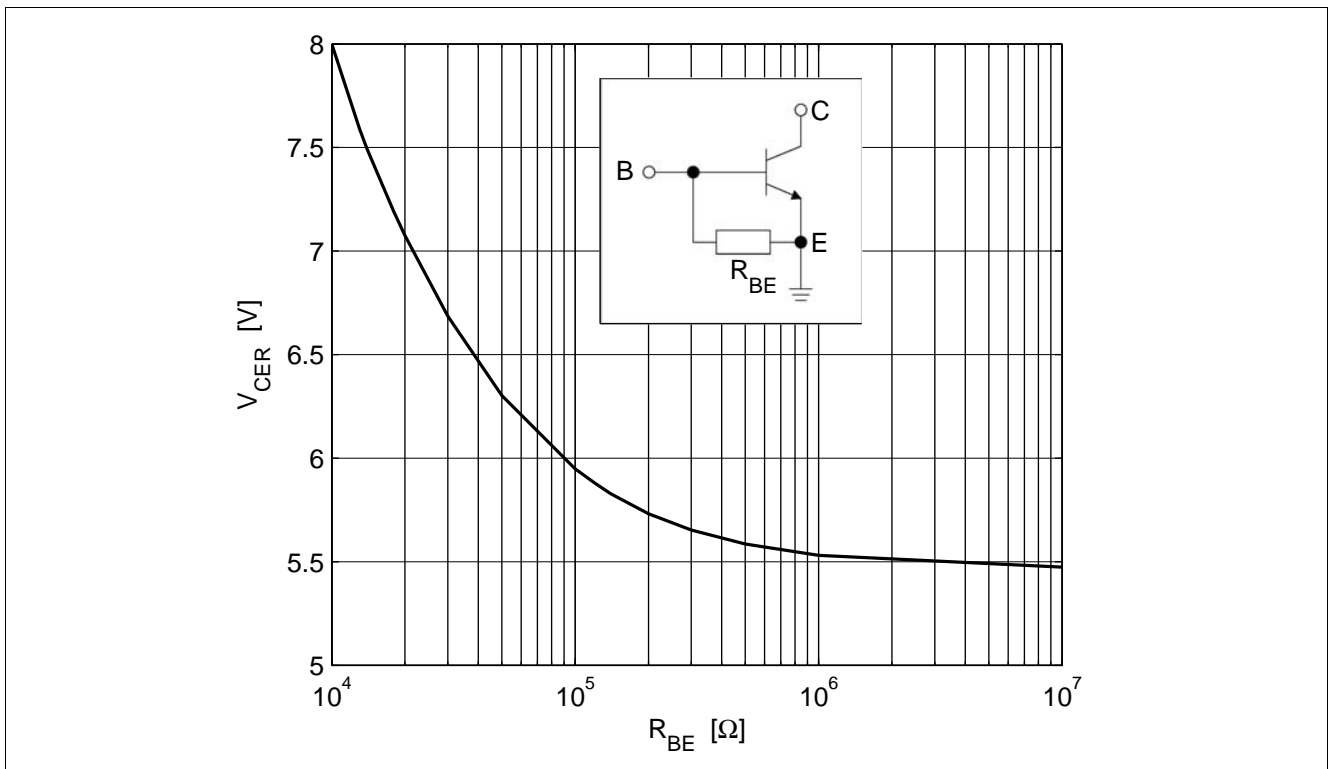

Figure 5-7 Collector Emitter Breakdown Voltage $V_{CER} = f(R_{BE})$, $I_C = 1\text{ mA}$

5.5 Characteristic AC Diagrams

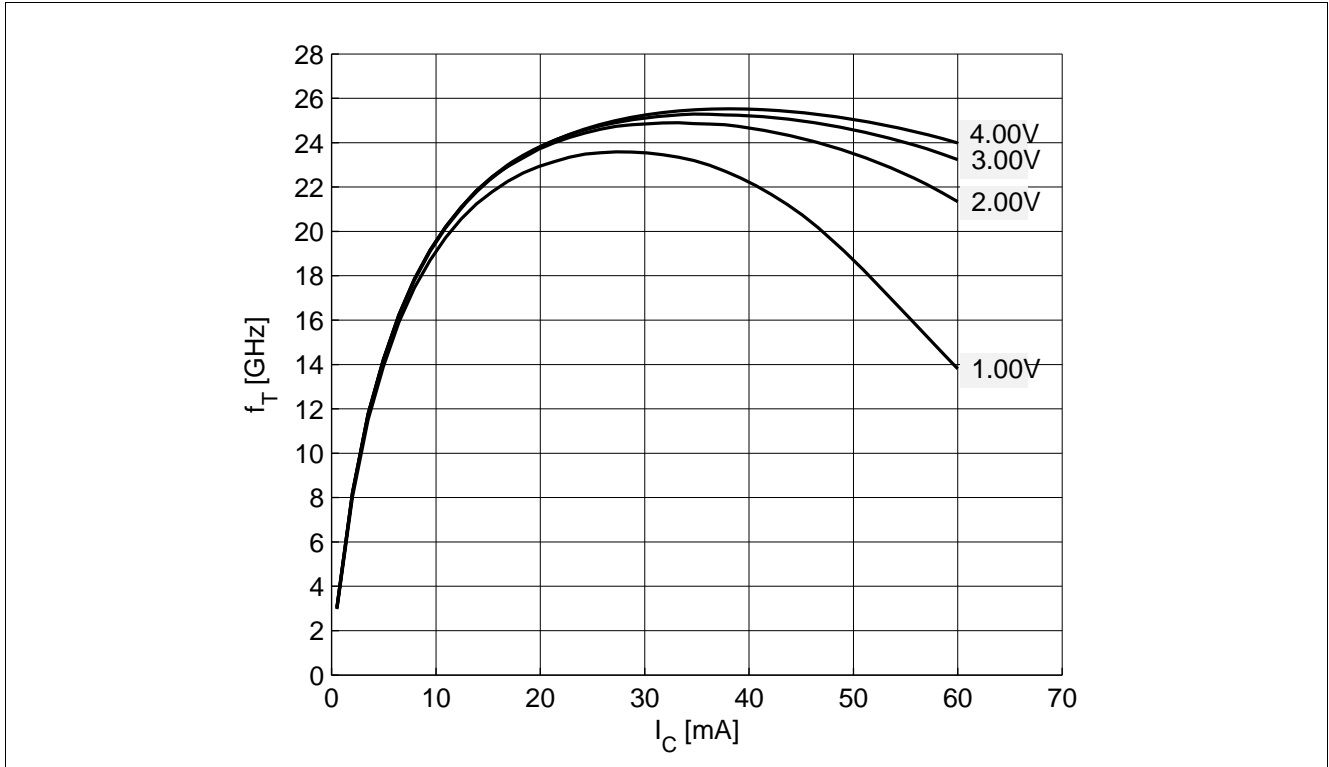

Figure 5-8 Transition Frequency $f_T = f(I_C)$, $f = 2$ GHz, $V_{CE} =$ Parameter in V

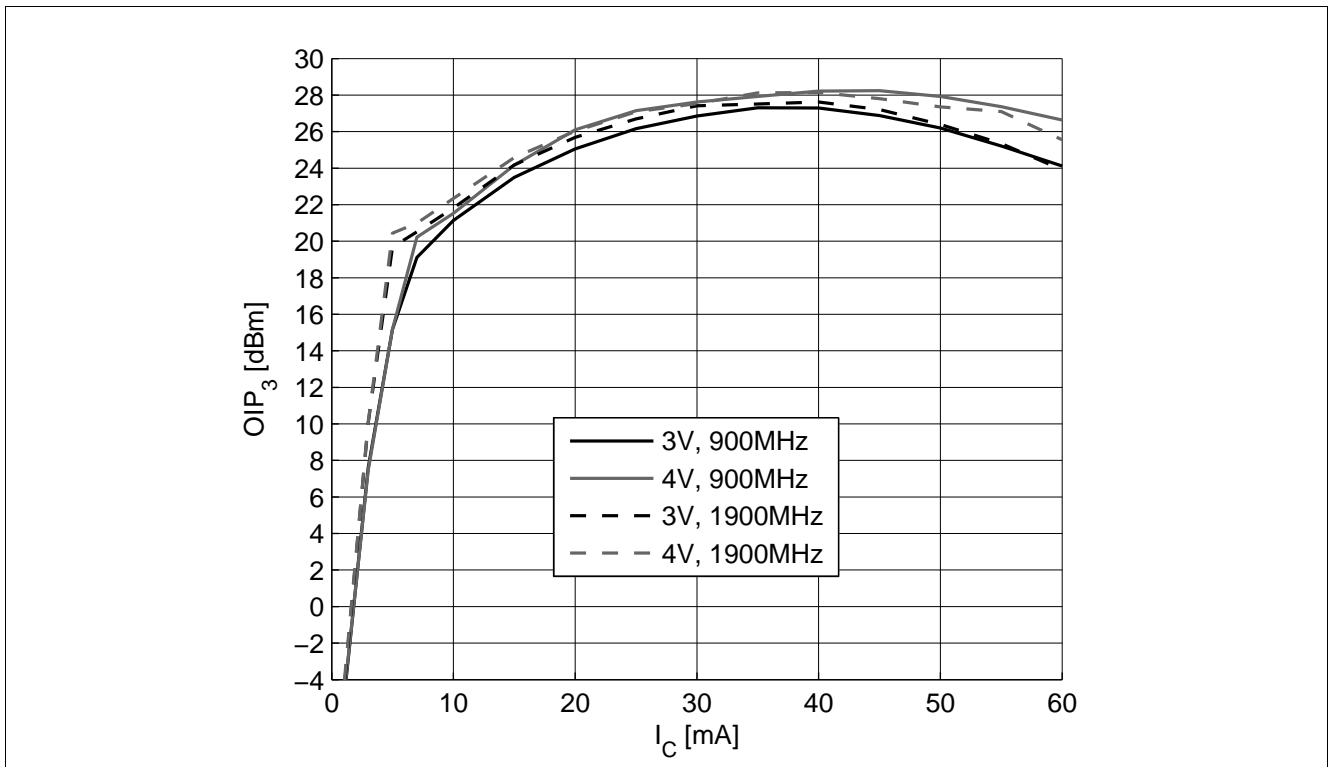

Figure 5-9 3rd Order Intercept Point $OIP_3 = f(I_C)$, $Z_S = Z_L = 50 \Omega$, $V_{CE}, f =$ Parameters

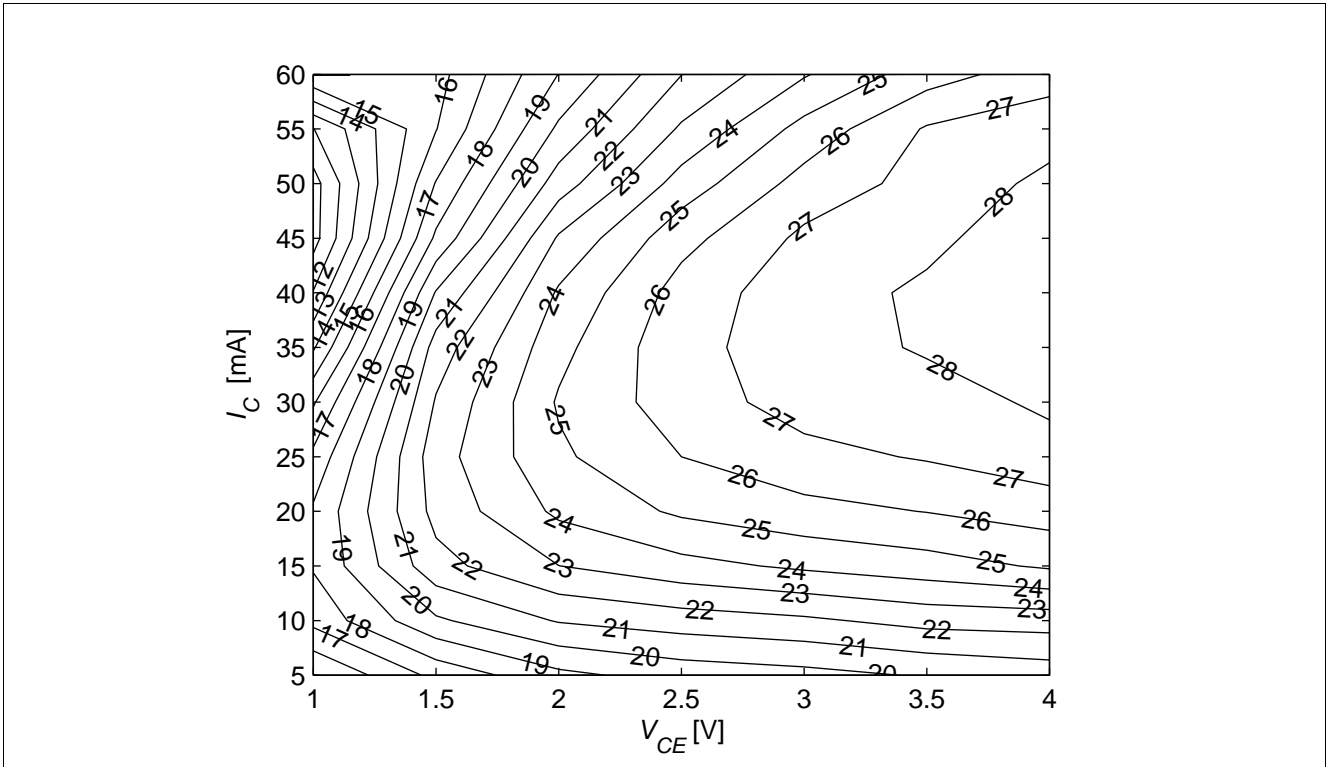

Figure 5-10 3rd Order Intercept Point at output OIP_3 [dBm] = $f(I_C, V_{CE})$, $Z_S = Z_L = 50 \Omega$, $f = 1900$ MHz

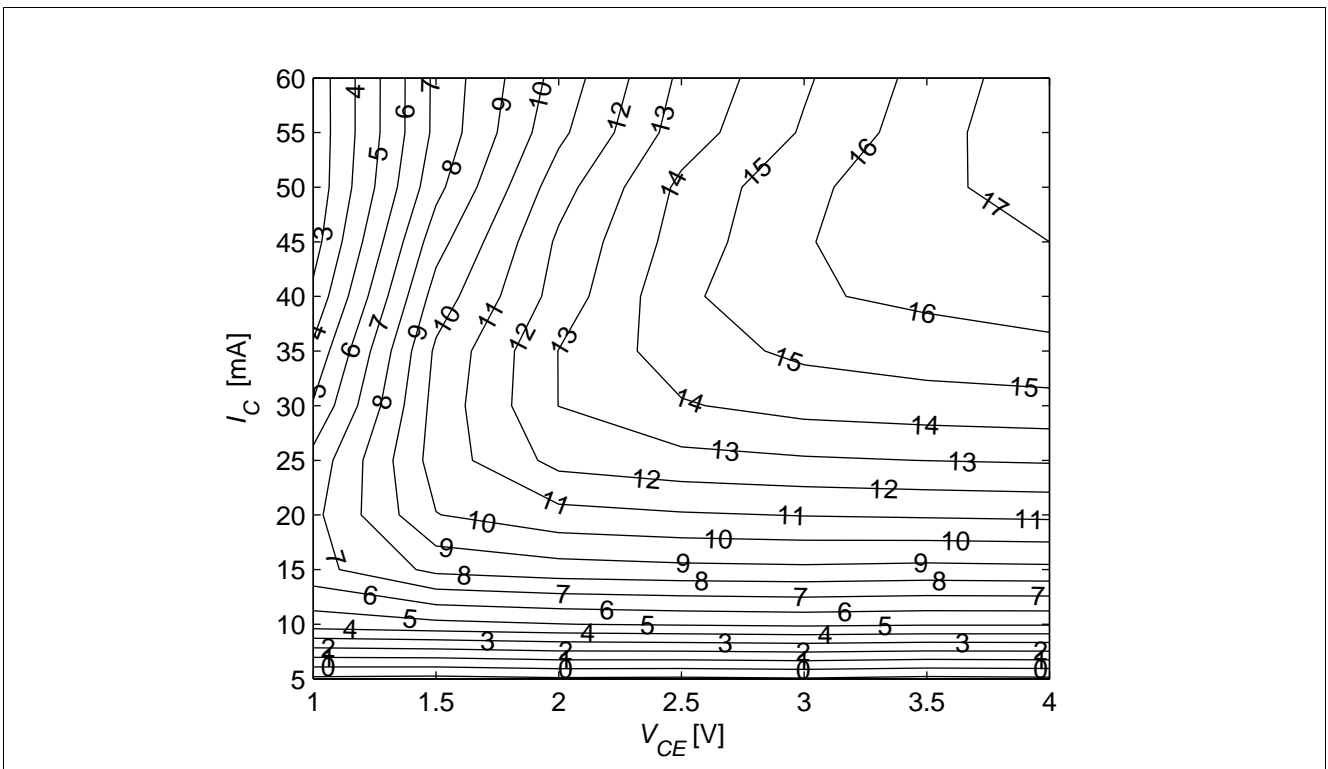

Figure 5-11 Compression Point at output OP_{1dB} [dBm] = $f(I_C, V_{CE})$, $Z_S = Z_L = 50 \Omega$, $f = 1900$ MHz

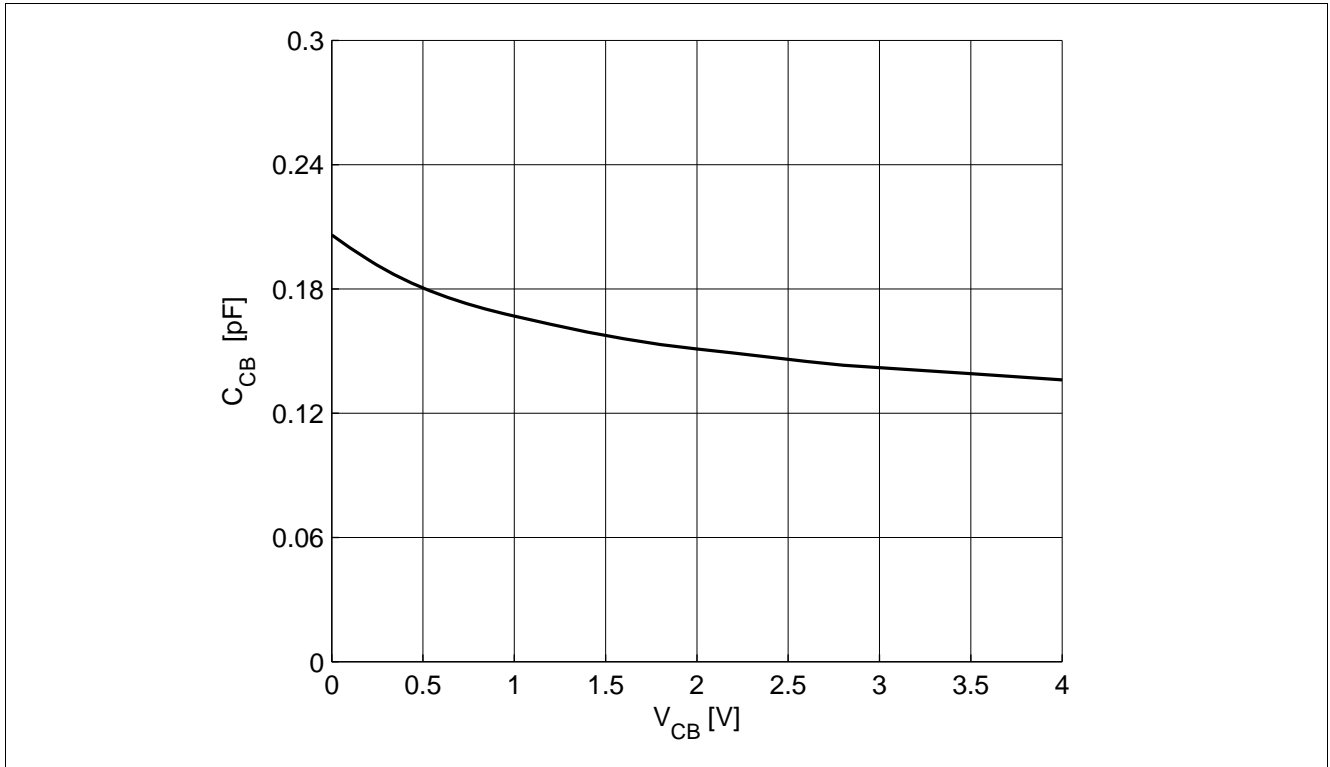

Figure 5-12 Collector Base Capacitance $C_{CB} = f(V_{CB}), f = 1 \text{ MHz}$

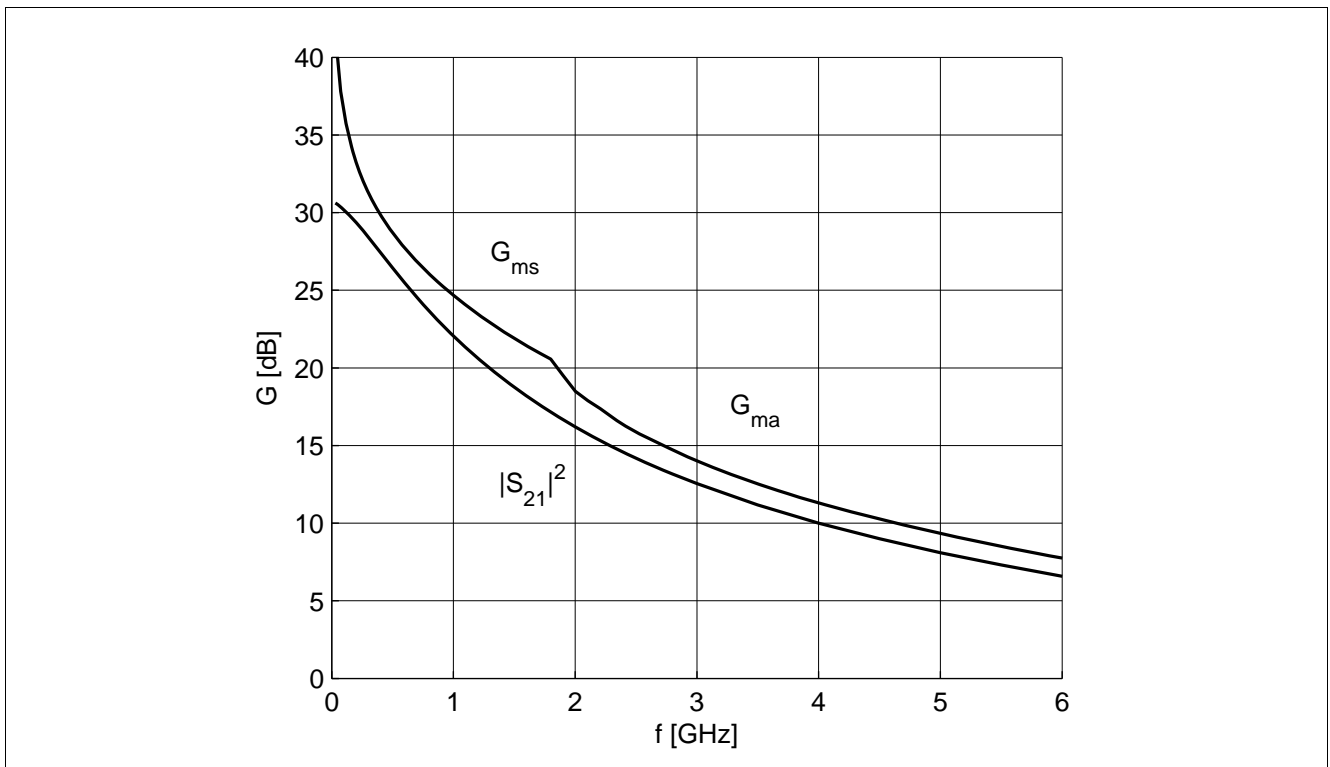

Figure 5-13 Gain $G_{ma}, G_{ms}, |S_{21}|^2 = f(f), V_{CE} = 3 \text{ V}, I_C = 15 \text{ mA}$

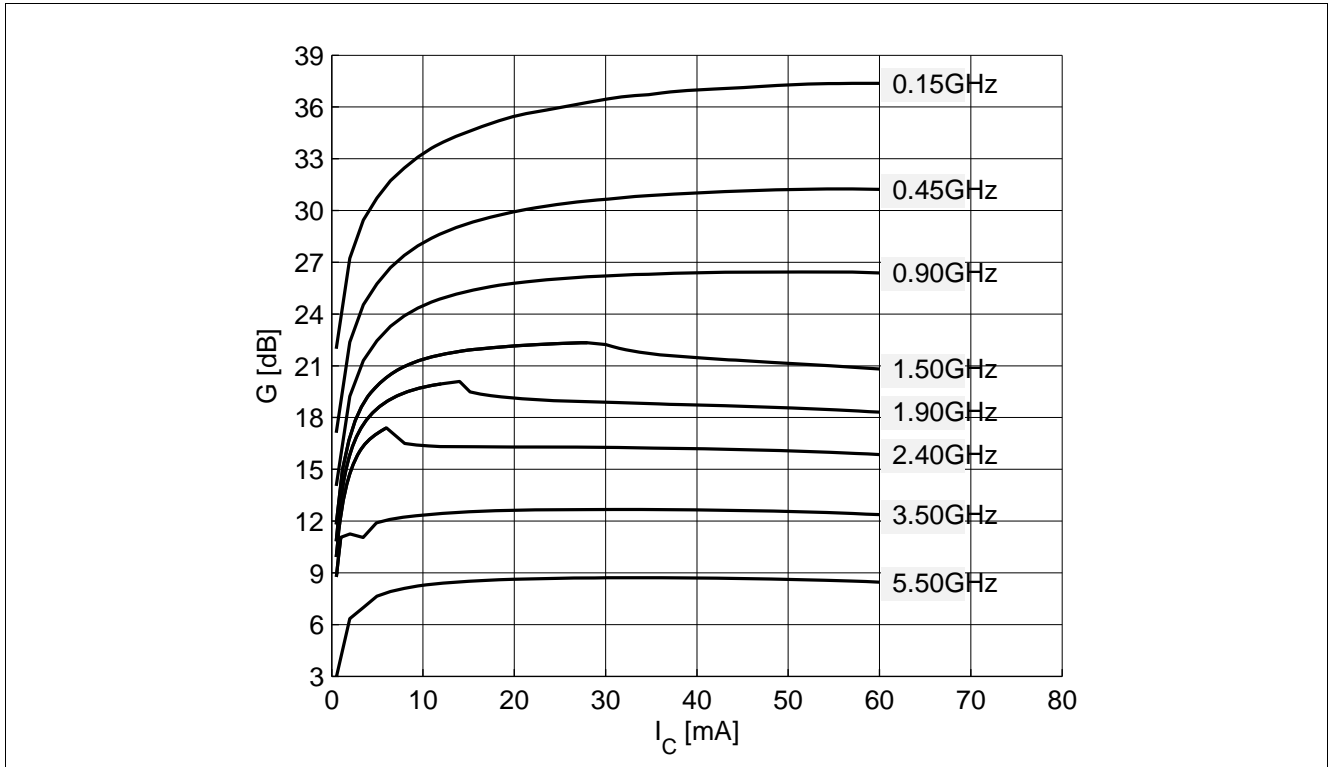

Figure 5-14 Maximum Power Gain $G_{max} = f(I_C)$, $V_{CE} = 3\text{ V}$, $f = \text{Parameter in GHz}$

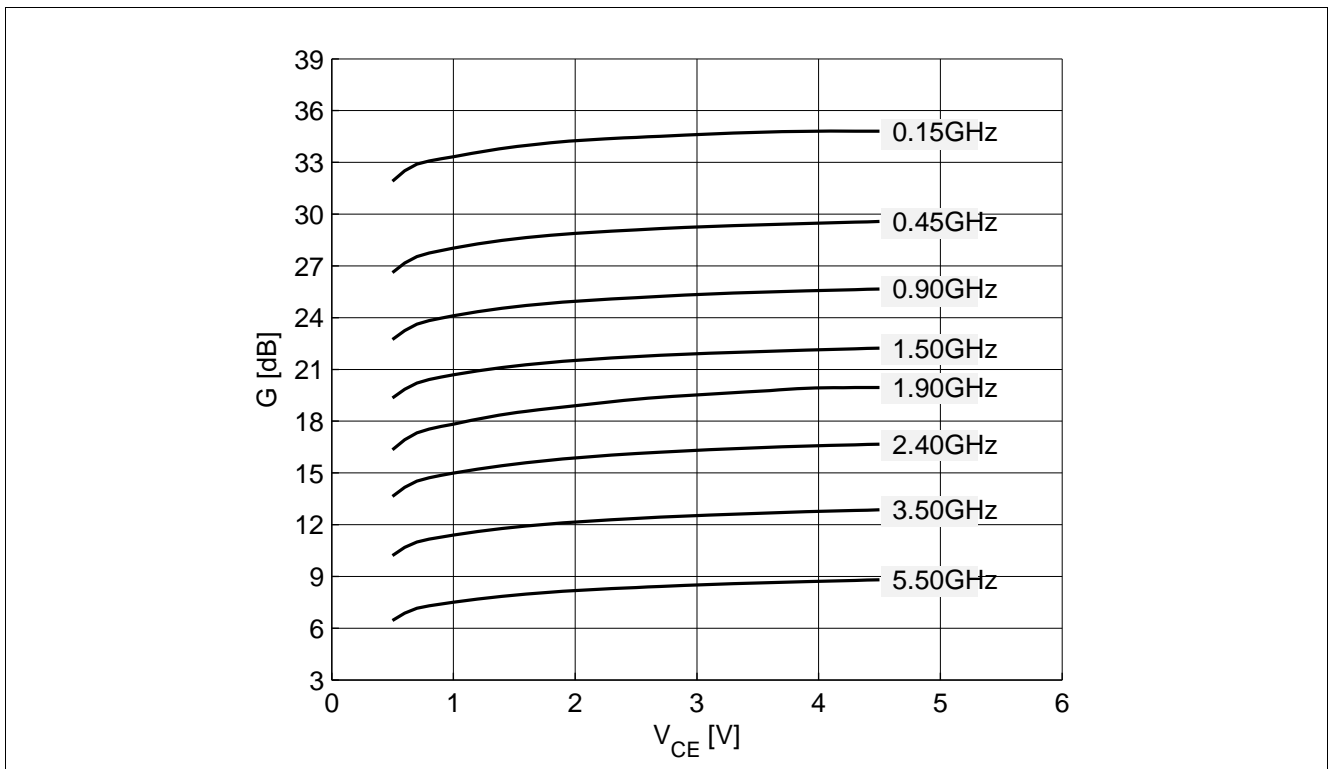

Figure 5-15 Maximum Power Gain $G_{max} = f(V_{CE})$, $I_C = 15\text{ mA}$, $f = \text{Parameter in GHz}$

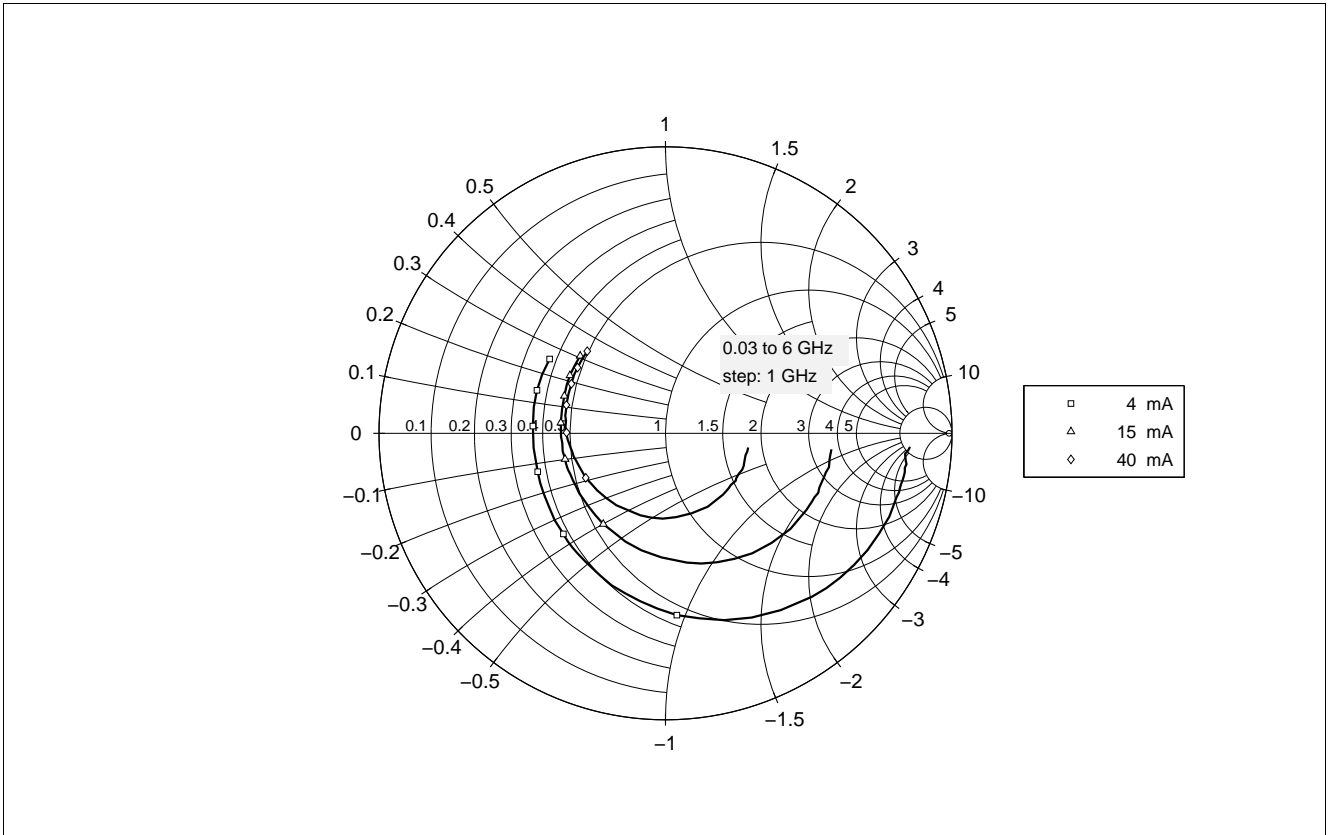

Figure 5-16 Input Matching $S_{11} = f(f)$, $V_{CE} = 3\text{ V}$, $I_C = 4 / 15 / 40\text{ mA}$

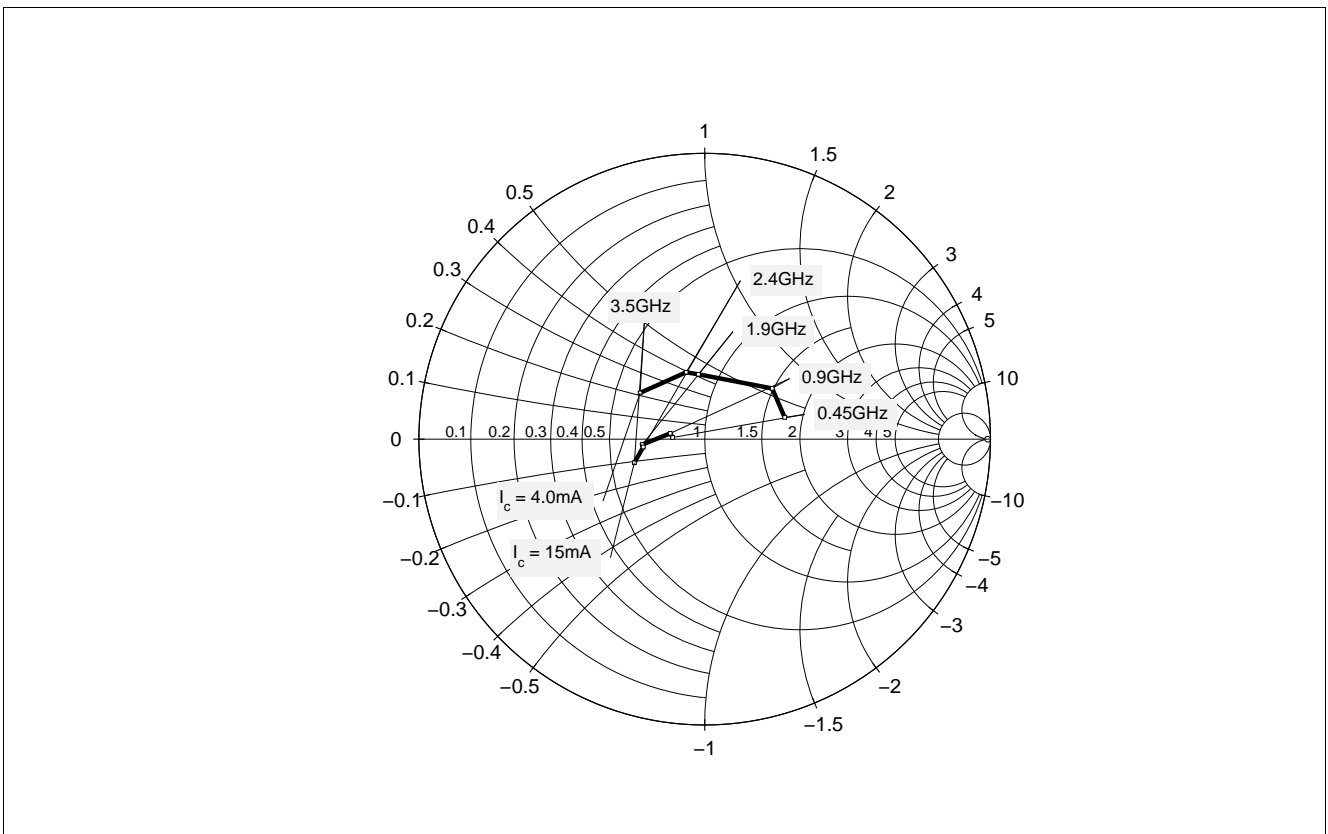

Figure 5-17 Source Impedance for Minimum Noise Figure $Z_{opt} = f(f)$, $V_{CE} = 3\text{ V}$, $I_C = 4 / 15\text{ mA}$

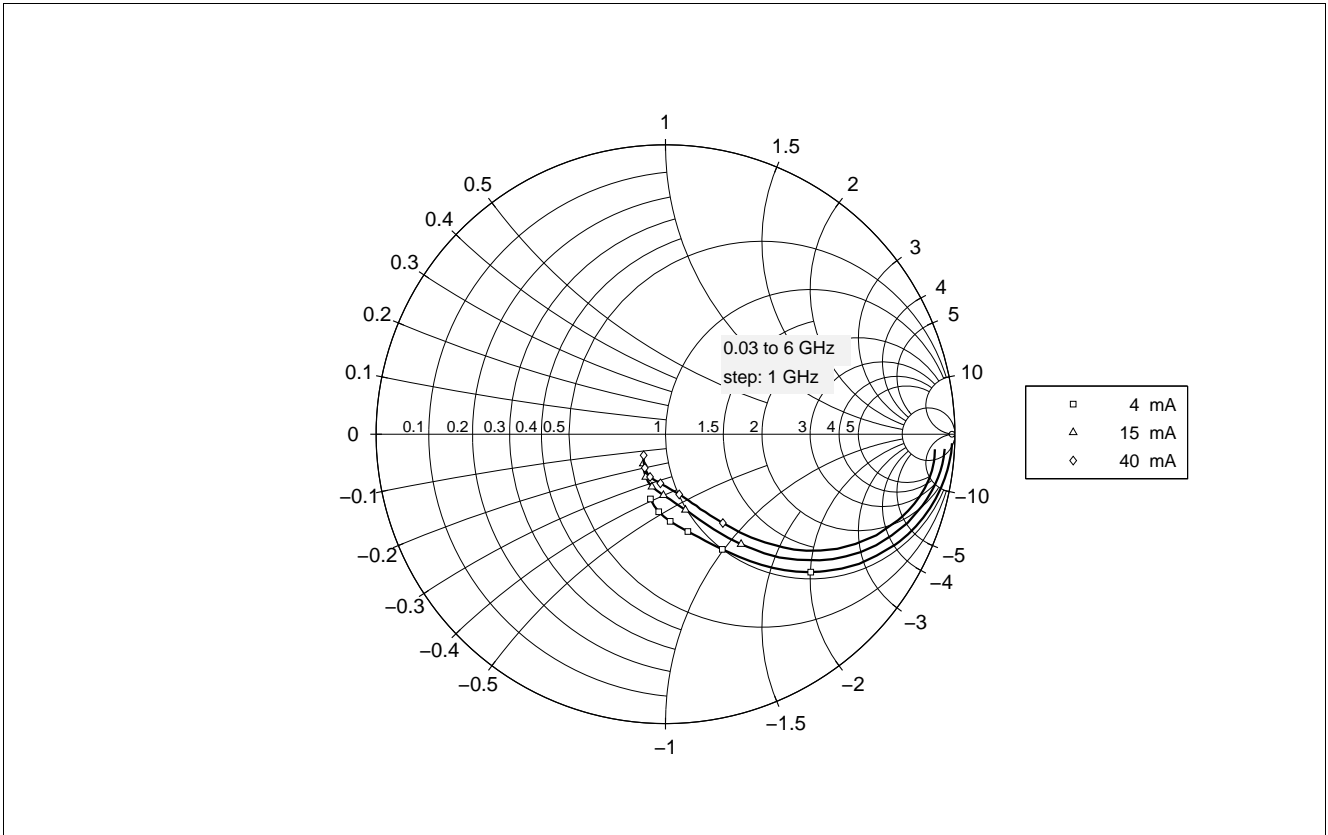

Figure 5-18 Output Matching $S_{22} = f(f)$, $V_{CE} = 3\text{ V}$, $I_C = 4 / 15 / 40\text{ mA}$

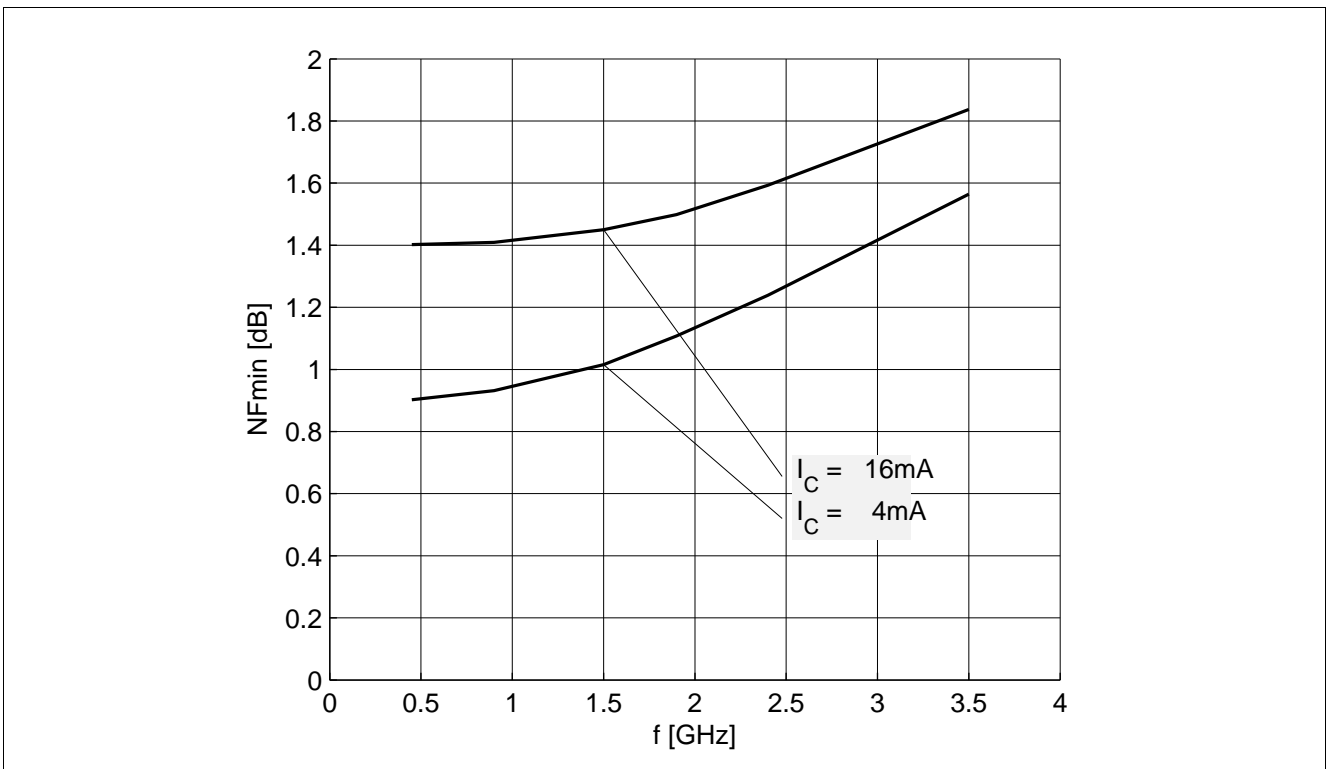

Figure 5-19 Noise Figure $NF_{min} = f(f)$, $V_{CE} = 3\text{ V}$, $I_C = 4 / 16\text{ mA}$, $Z_S = Z_{opt}$

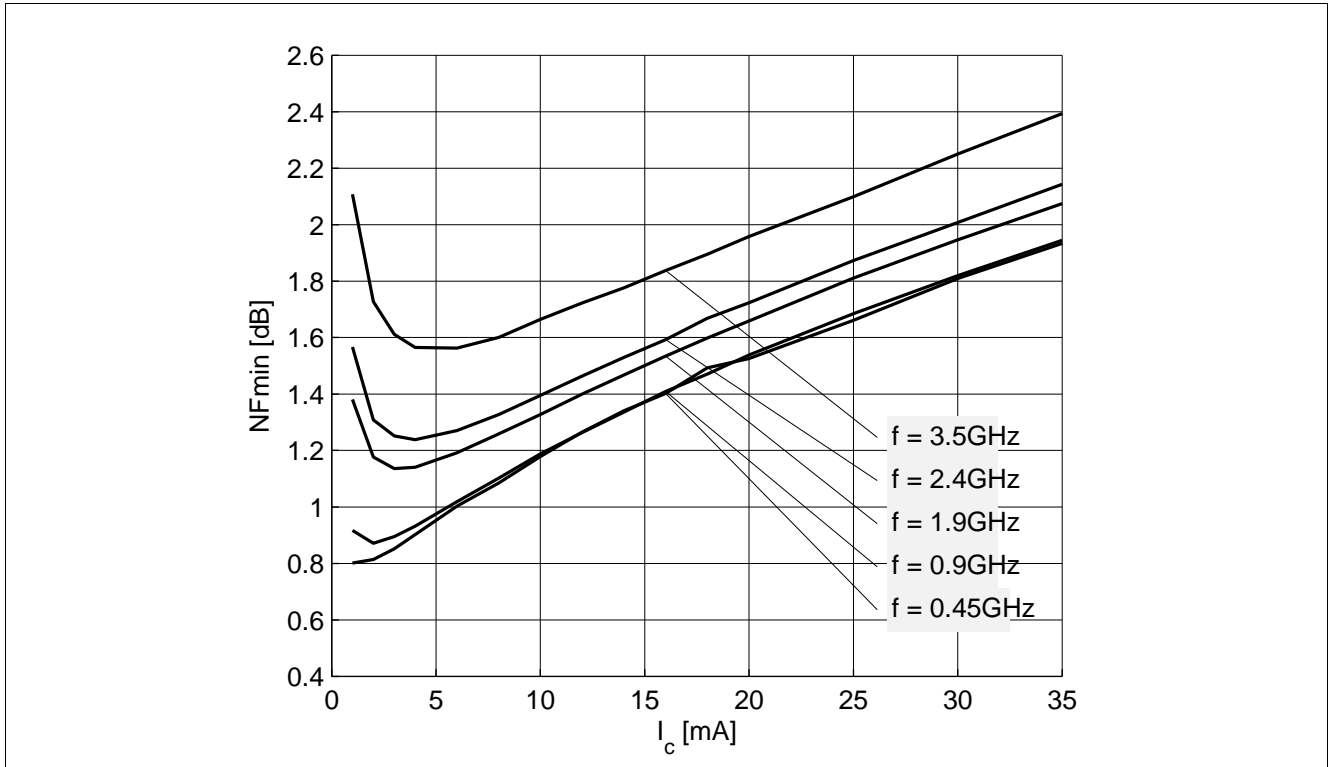

Figure 5-20 Noise Figure $NF_{min} = f(I_c)$, $V_{CE} = 3\text{ V}$, $Z_S = Z_{opt}$, $f = \text{Parameter in GHz}$

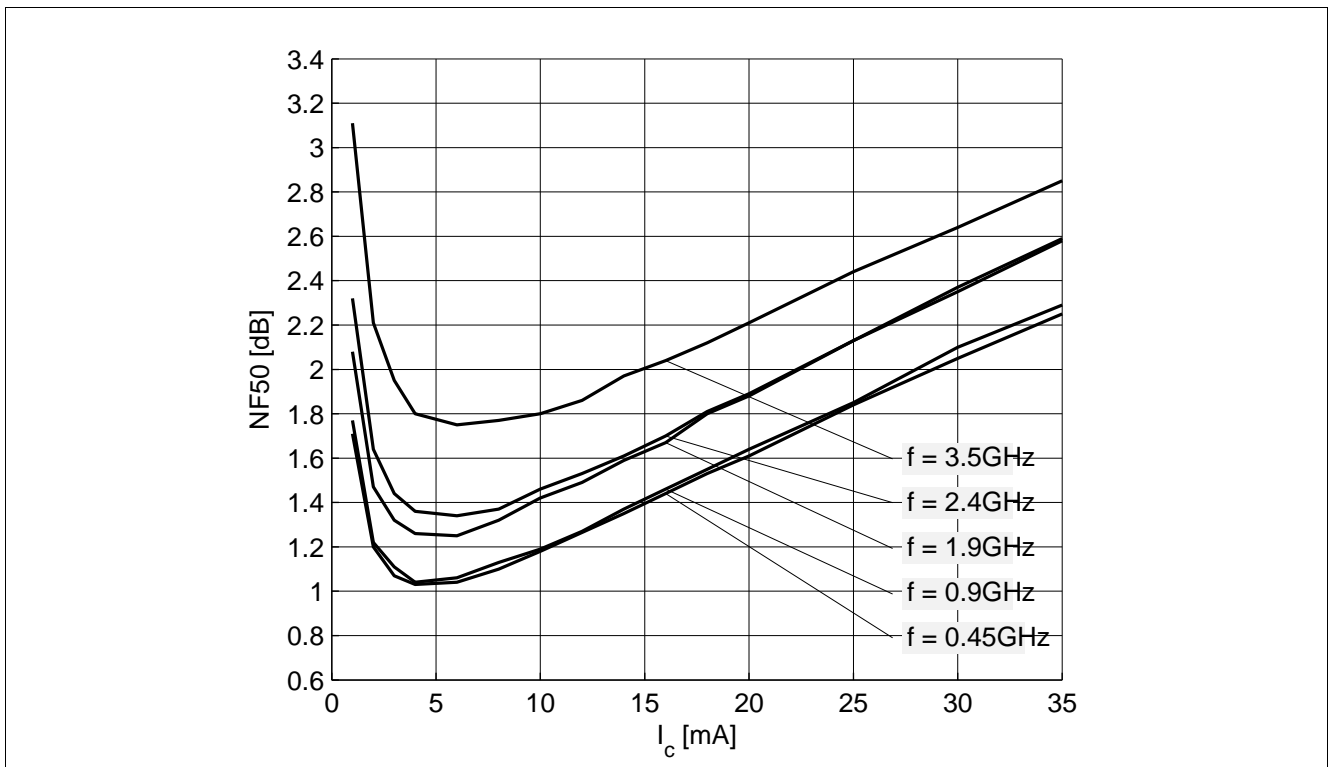

Figure 5-21 Noise Figure $NF_{50} = f(I_c)$, $V_{CE} = 3\text{ V}$, $Z_S = 50\ \Omega$, $f = \text{Parameter in GHz}$

Note: The curves shown in this chapter have been generated using typical devices but shall not be considered as a guarantee that all devices have identical characteristic curves. $T_A = 25\text{ }^\circ\text{C}$.

6 Simulation Data

For the SPICE Gummel Poon (GP) model as well as for the S-parameters (including noise parameters) please consult our website and download the latest versions before actually starting your design.

You find the BFP420F SPICE GP model on the official homepage of Infineon RF transistors in MWO- and ADS-format, which you can import into these circuit simulation tools very quickly and conveniently. The model already contains the package parasitics and is ready to use for DC- and high frequency simulations. The terminals of the model circuit correspond to the pin configuration of the device.

The model parameters have been extracted and verified up to 10 GHz using typical devices. The BFP420F SPICE GP model reflects the typical DC- and RF-performance within the limitations which are given by the SPICE GP model itself. Besides the DC characteristics all S-parameters in magnitude and phase, as well as noise figure (including optimum source impedance, equivalent noise resistance and flicker noise) and intermodulation have been extracted.

7 Package Information TSFP-4-1

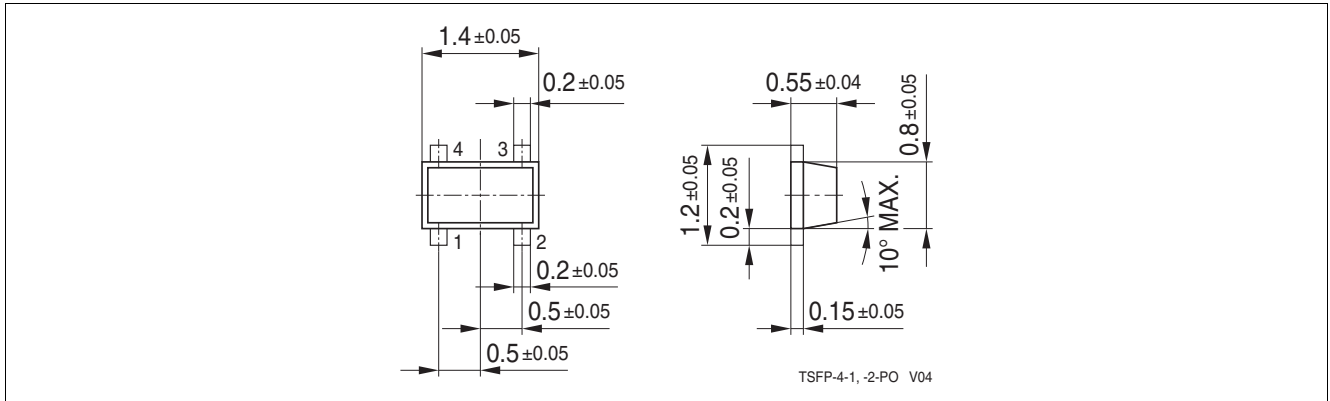

Figure 7-1 Package Outline

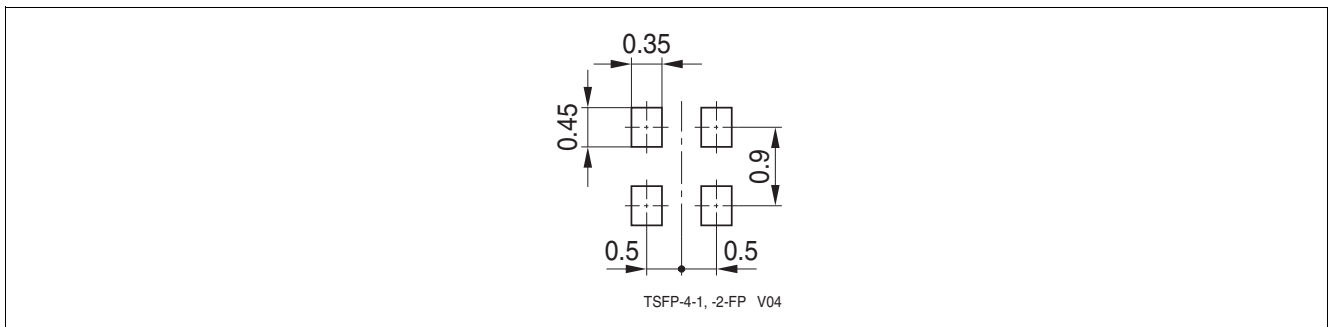

Figure 7-2 Package Footprint

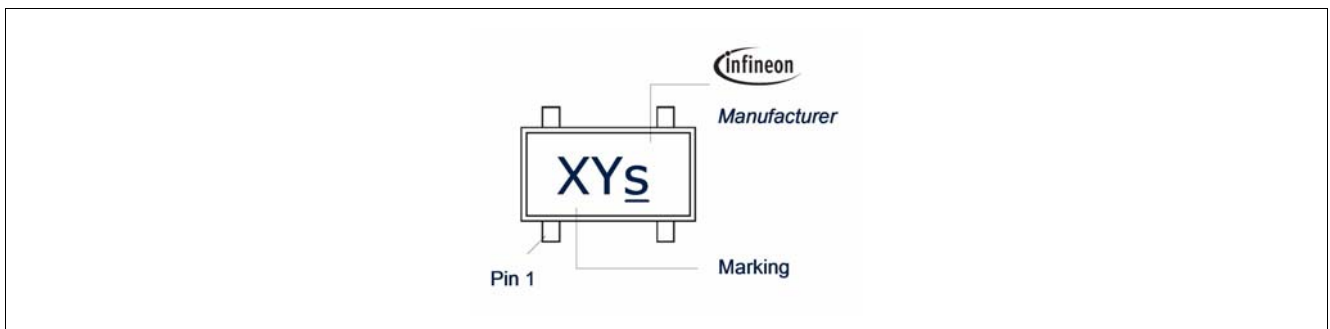

Figure 7-3 Marking Description (Marking BFP420F: AMs)

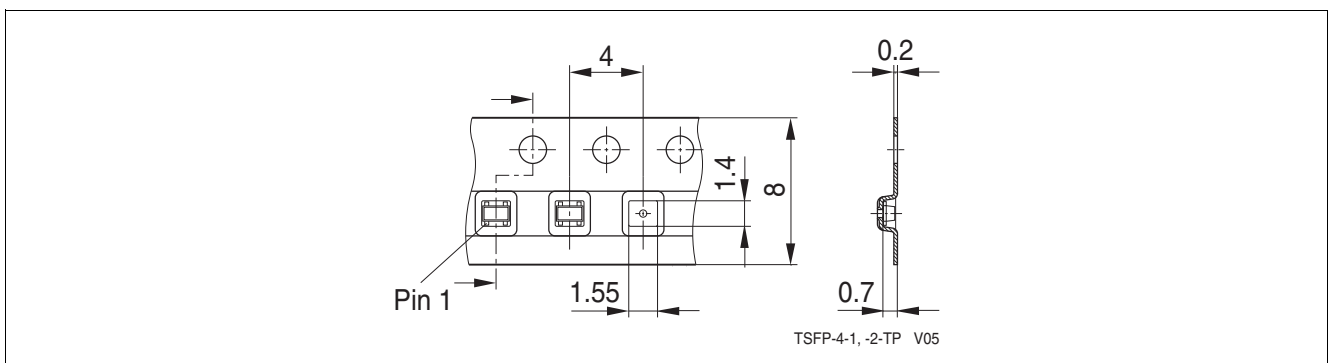

Figure 7-4 Tape Dimensions

www.infineon.com

Published by Infineon Technologies AG