



# 1.2A, Current-Limited, High-Side P-Channel Switch with Thermal Shutdown

## ABSOLUTE MAXIMUM RATINGS

IN to GND .....	-0.3V to +6V	Operating Temperature Range	
$\overline{\text{ON}}$ , FAULT to GND .....	-0.3V to +6V	MAX893LESA .....	-40°C to +85°C
SET, OUT to GND .....	-0.3V to ( $V_{\text{IN}} + 0.3\text{V}$ )	Storage Temperature Range .....	-65°C to +150°C
Maximum Continuous Short-Circuit Switch Current .....	2.0A	Lead Temperature (soldering, 10sec) .....	+300°C
Continuous Power Dissipation ( $T_{\text{A}} = +70^{\circ}\text{C}$ )			
SO (derate 5.88mW/°C above +70°C) .....	471mW		

Stresses beyond those listed under "Absolute Maximum Ratings" may cause permanent damage to the device. These are stress ratings only, and functional operation of the device at these or any other conditions beyond those indicated in the operational sections of the specifications is not implied. Exposure to absolute maximum rating conditions for extended periods may affect device reliability.

## ELECTRICAL CHARACTERISTICS

( $V_{\text{IN}} = 3\text{V}$ ,  $T_{\text{A}} = 0^{\circ}\text{C}$  to  $+85^{\circ}\text{C}$ , unless otherwise noted. Typical values are at  $T_{\text{A}} = +25^{\circ}\text{C}$ .)

PARAMETER	CONDITIONS	MIN	TYP	MAX	UNITS
Operating Voltage		2.7		5.5	V
Quiescent Current	$V_{\text{IN}} = 5\text{V}$ , $\overline{\text{ON}} = \text{GND}$ , $I_{\text{OUT}} = 0$		13	20	$\mu\text{A}$
Off-Supply Current	$\overline{\text{ON}} = \text{IN}$ , $V_{\text{IN}} = V_{\text{OUT}} = 5.5\text{V}$		0.03	1	$\mu\text{A}$
Off-Switch Current	$\overline{\text{ON}} = \text{IN}$ , $V_{\text{IN}} = 5.5\text{V}$ , $V_{\text{OUT}} = 0$		0.04	15	$\mu\text{A}$
Undervoltage Lockout	Rising edge, 1% hysteresis	2.0	2.4	2.6	V
On-Resistance	$V_{\text{IN}} = 4.5\text{V}$		70	125	$\text{m}\Omega$
	$V_{\text{IN}} = 3.0\text{V}$		88	160	
Current-Limit-Amplifier Threshold	$V_{\text{SET}}$ required to turn the switch off (Note 1)	1.178	1.240	1.302	V
Maximum Programmable Continuous Output Current Limit			1.2		A
Short-Circuit Current			1.8		A
$I_{\text{OUT}}$ to $I_{\text{SET}}$ Current Ratio	$I_{\text{OUT}} = 500\text{mA}$ , $V_{\text{OUT}} > 1.6\text{V}$	920	1080	1250	A/A
$\overline{\text{ON}}$ Input Voltage Low	$V_{\text{IN}} = 2.7\text{V}$ to $5.5\text{V}$			0.8	V
$\overline{\text{ON}}$ Input Voltage High	$V_{\text{IN}} = 2.7\text{V}$ to $3.6\text{V}$	2.0			V
	$V_{\text{IN}} = 4.5\text{V}$ to $5.5\text{V}$	2.4			
$\overline{\text{ON}}$ Input Leakage Current	$V_{\overline{\text{ON}}} = 5.5\text{V}$		0.01	1	$\mu\text{A}$
$I_{\text{SET}}$ Bias Current	$V_{\text{SET}} = 1.24\text{V}$ , $I_{\text{OUT}} = 0$ ; $V_{\text{IN}} = V_{\text{OUT}}$		0.5	3	$\mu\text{A}$
FAULT Logic Output Voltage Low	$I_{\text{SINK}} = 1\text{mA}$ , $V_{\text{SET}} = 1.4\text{V}$			0.4	V
FAULT Logic Output High Leakage Current	$V_{\text{FAULT}} = 5.5\text{V}$ , $V_{\text{SET}} = 1\text{V}$		0.05	1	$\mu\text{A}$
Slow Current-Loop Response Time	20% current overdrive, $V_{\text{IN}} = 5\text{V}$		5		$\mu\text{s}$
Fast Current-Loop Response Time			2		$\mu\text{s}$
Turn-On Time	$V_{\text{IN}} = 5\text{V}$ , $I_{\text{OUT}} = 500\text{mA}$		80	200	$\mu\text{s}$
	$V_{\text{IN}} = 3\text{V}$ , $I_{\text{OUT}} = 500\text{mA}$		115		
Turn-Off Time	$V_{\text{IN}} = 5\text{V}$ , $I_{\text{OUT}} = 500\text{mA}$	2	4		$\mu\text{s}$

# 1.2A, Current-Limited, High-Side P-Channel Switch with Thermal Shutdown

MAX893L

## ELECTRICAL CHARACTERISTICS

( $V_{IN} = 3V$ ,  $T_A = -40^{\circ}C$  to  $+85^{\circ}C$ , unless otherwise noted.) (Note 2)

PARAMETER	CONDITIONS	MIN	TYP	MAX	UNITS
Operating Voltage		3.0		5.5	V
Quiescent Current	$V_{IN} = 5V$ , $\overline{ON} = GND$ , $I_{OUT} = 0$			30	$\mu A$
Off-Supply Current	$\overline{ON} = IN$ , $V_{IN} = V_{OUT} = 5.5V$			2.2	$\mu A$
Off-Switch Current	$\overline{ON} = IN$ , $V_{IN} = 5.5V$ , $V_{OUT} = 0$			15	$\mu A$
Undervoltage Lockout	Rising edge, 1% hysteresis	2.0		2.9	V
On-Resistance	$V_{IN} = 4.5V$			125	m $\Omega$
	$V_{IN} = 3.0V$			160	
Current-Limit-Amplifier Threshold	$V_{SET}$ required to turn the switch off (Note 1)	1.14		1.34	V
$I_{OUT}$ to $I_{SET}$ Current Ratio	$I_{OUT} = 500mA$ , $V_{OUT} > 1.6V$	865		1300	A/A
$\overline{FAULT}$ Logic Output Voltage Low	$I_{SINK} = 1mA$ , $V_{SET} = 1.4V$			0.4	V
Turn-On Time	$V_{IN} = 5V$ , $I_{OUT} = 500mA$			200	$\mu s$
Turn-Off Time	$V_{IN} = 5V$ , $I_{OUT} = 500mA$	1		20	$\mu s$

**Note 1:** Tested with  $I_{OUT} = 100mA$  and  $V_{SET}$  raised until  $V_{IN} - V_{OUT} \geq 0.8V$ .

**Note 2:** Specifications to  $-40^{\circ}C$  are guaranteed by design, not production tested.

# 1.2A, Current-Limited, High-Side P-Channel Switch with Thermal Shutdown

## Typical Operating Characteristics

( $T_A = +25^\circ\text{C}$ , unless otherwise noted.)

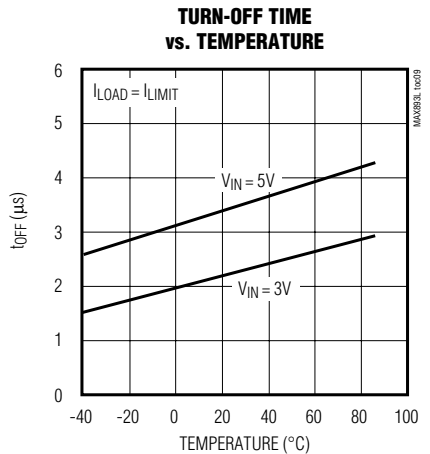
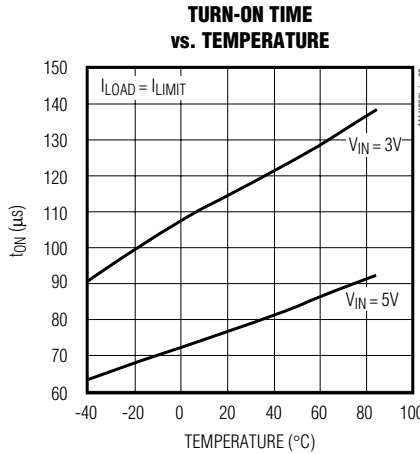
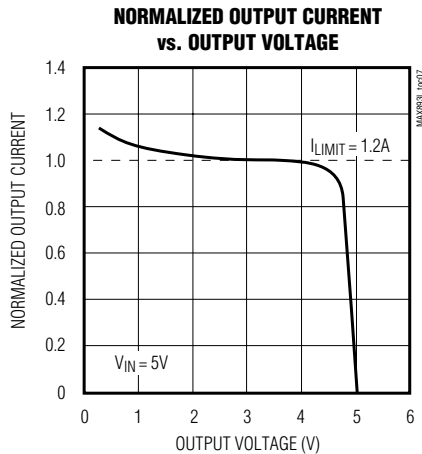
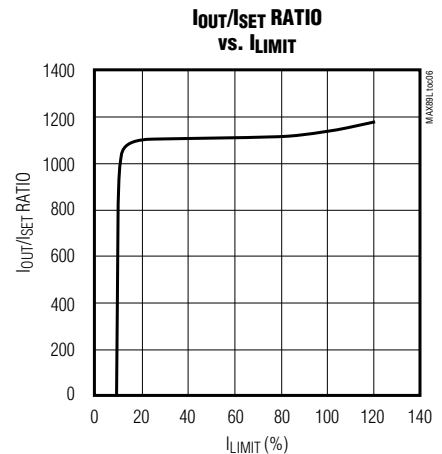
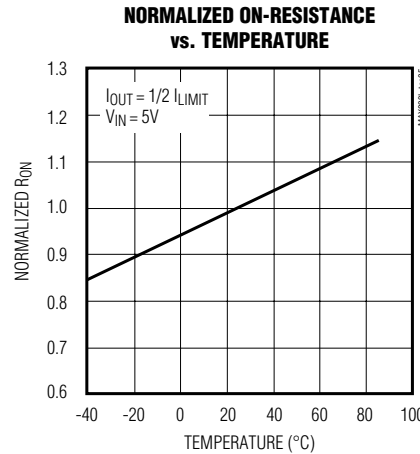
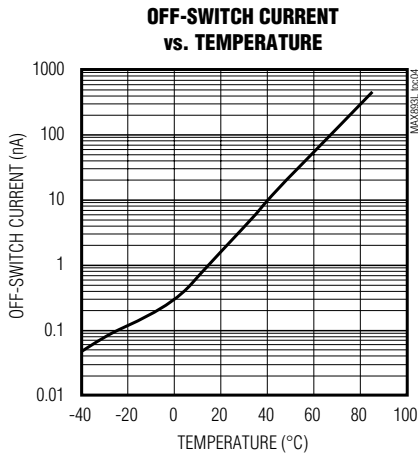
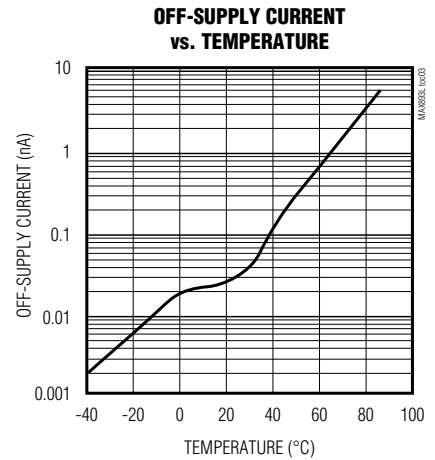
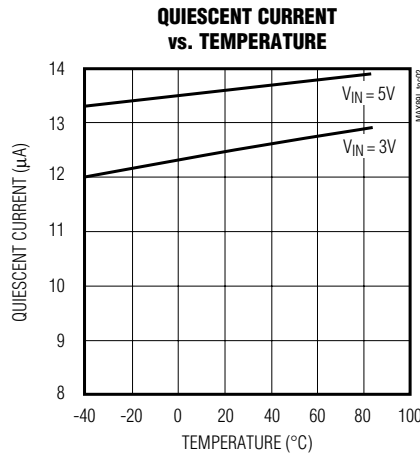
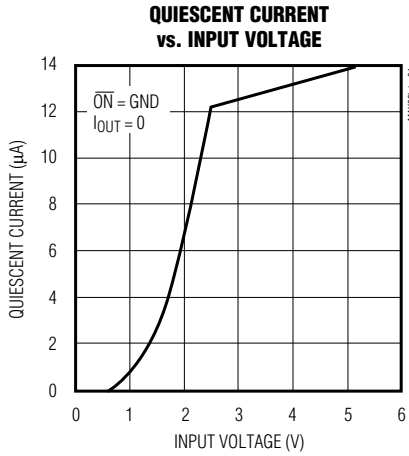

# 1.2A, Current-Limited, High-Side P-Channel Switch with Thermal Shutdown

**MAX893L**

## Typical Operating Characteristics (continued)

( $T_A = +25^\circ\text{C}$ , unless otherwise noted.)

**OUTPUT OVERLOAD  
(SLOW-LOOP RESPONSE)**

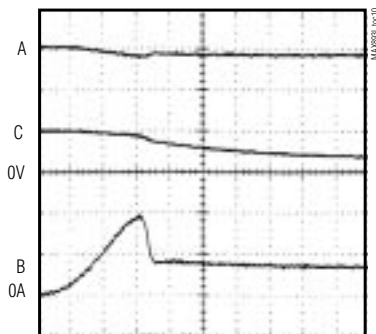

2 $\mu\text{s/div}$   
 $C_{IN} = 100\mu\text{F}$ ,  $C_{OUT} = 0.1\mu\text{F}$     B:  $I_{OUT}$ , 1A/div  
 A:  $V_{IN}$ , 1V/div, AC-COUPLED    C:  $V_{OUT}$ , 5V/div

**OUTPUT SHORT CIRCUIT  
(FAST-LOOP RESPONSE)**

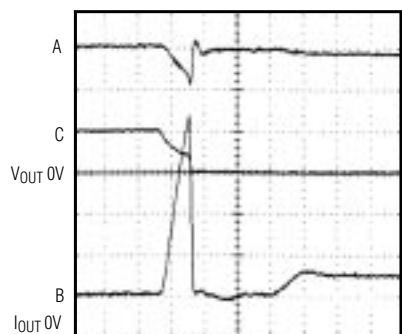

2 $\mu\text{s/div}$   
 $C_{IN} = 100\mu\text{F}$ ,  $C_{OUT} = 0.1\mu\text{F}$     B:  $I_{OUT}$ , 2A/div  
 A:  $V_{IN}$ , 1V/div, AC-COUPLED    C:  $V_{OUT}$ , 5V/div

**SWITCH TURN-ON TIME**

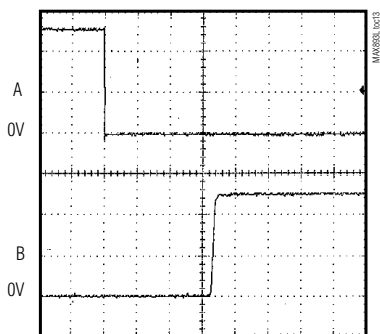

20 $\mu\text{s/div}$   
 $V_{IN} = 5\text{V}$ ,  $I_{OUT} = I_{LIMIT}/2$   
 A:  $V_{ON}$ , 2V/div  
 B:  $V_{OUT}$ , 2V/div

**SWITCH TURN-OFF TIME**

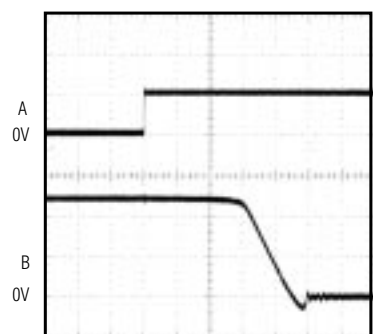

1 $\mu\text{s/div}$   
 $V_{IN} = 5\text{V}$ ,  $I_{OUT} = I_{LIMIT}/2$   
 A:  $V_{ON}$ , 2V/div  
 B:  $V_{OUT}$ , 2V/div

# 1.2A, Current-Limited, High-Side P-Channel Switch with Thermal Shutdown

## Pin Description

PIN	NAME	FUNCTION
1, 2	IN	Input. P-channel MOSFET source. Bypass IN with a 1µF capacitor to ground.
3	ON	Active-Low Switch On Input. A logic low turns the switch on.
4	GND	Ground
5	SET	Set Current-Limit Input. A resistor from SET to ground sets the current limit for the switch. $R_{SET} = 1.34 \cdot 10^3 / I_{LIMIT}$ , where $I_{LIMIT}$ is the desired current limit in amperes.
6, 7	OUT	Switch Output. P-channel MOSFET drain. Bypass OUT with a 0.1µF capacitor to ground.
8	FAULT	Fault-Indicator Output. This open-drain output goes low when in current limit or when the die temperature exceeds +165°C.

## Detailed Description

The MAX893L P-channel MOSFET power switch limits output current to a programmed level. When the output current is increased beyond the programmed current limit, or 1.2A ( $I_{MAX}$ ), the current also increases through the replica switch ( $I_{OUT} / 1080$ ) and through  $R_{SET}$  (Figure 1). The current-limit error amplifier compares the voltage across  $R_{SET}$  to the internal 1.24V reference, and regulates the current to the programmed current limit ( $I_{LIMIT}$ ).

This switch is not bidirectional; therefore, the input voltage must be higher than the output voltage.

### Setting the Current Limit

The MAX893L features internal current-limiting circuitry with a maximum programmable value ( $I_{MAX}$ ) of 1.2A. For best performance, set the current limit ( $I_{LIMIT}$ ) between  $0.2A \leq I_{LIMIT} \leq 1.2A$ . This current limit remains in effect throughout the input supply-voltage range.

Program the current limit with a resistor ( $R_{SET}$ ) from SET to ground (Figure 2) as follows:

$$I_{SET} = I_{LIMIT} / 1080$$

$$R_{SET} = 1.24V / I_{SET} = 1.34 \cdot 10^3 / I_{LIMIT}$$

where  $I_{LIMIT}$  is the desired current limit.

### Short-Circuit Protection

The MAX893L is a short-circuit protected switch. In the event of an output short circuit or a current overload condition, the current through the switch is limited by the internal current-limiting error amplifier to  $1.5 \cdot I_{LIMIT}$ . The short-circuit current is typically 1.8A for a programmed current limit of 1.2A. When the short-circuit condition is removed, the replica error amplifier will set the current limit back to  $I_{LIMIT}$ .

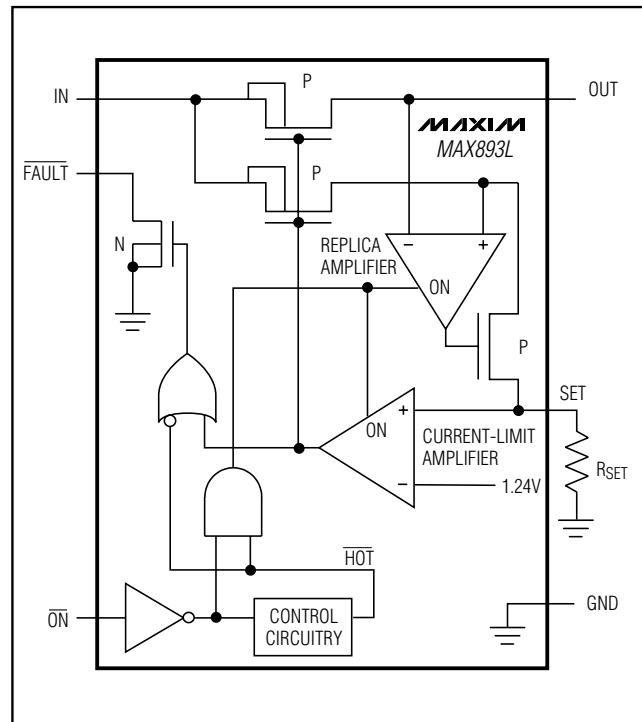

Figure 1. Functional Diagram

For a high  $\Delta V_{DS}/\Delta t$  during an output short-circuit condition, the switch turns off and disconnects the input supply from the output. The current-limiting amplifier then slowly turns the switch on with the output current limited to  $1.5 \cdot I_{LIMIT}$ . When the short-circuit condition is removed, the current limit is set back to  $I_{LIMIT}$ . See Output Short-Circuit (Fast-Loop Response) and Output Overload (Slow-Loop Response) in the *Typical Operating Characteristics*.

# 1.2A, Current-Limited, High-Side P-Channel Switch with Thermal Shutdown

MAX893L

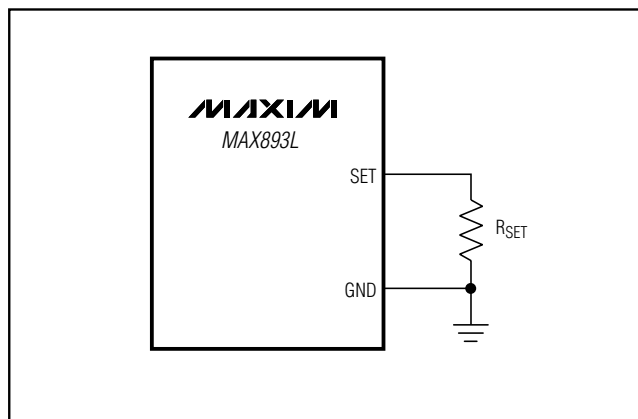

Figure 2. Setting the Current Limit

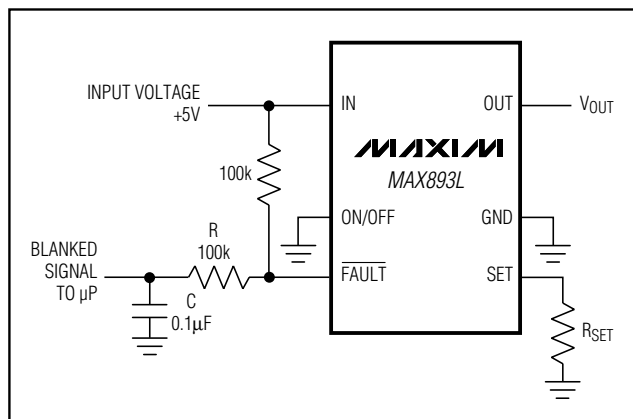

Figure 3. Fault-Blanking Circuit

### Thermal Shutdown

The MAX893L features thermal shutdown. The switch turns off when the junction temperature exceeds +165°C. Once the device cools by 10°C, the switch turns back on. If the fault condition is not removed, the switch will cycle on and off, resulting in a pulsed output.

### Fault Indicator

The MAX893L provides a fault output (FAULT). This open-drain output goes low when in current limit or when the die temperature exceeds +165°C. A 100kΩ pull-up resistor from FAULT to IN provides a logic-control signal.

### Fault Blanking

During start-up in USB applications, the MAX893L charges the relatively large USB capacitance. This may activate an unwanted fault signal if the charging current exceeds the programmed current limit. To “blank out” this start-up fault signal, add a simple lowpass RC delay circuit as shown in Figure 3. This circuit provides a 10ms delay.

## Applications Information

### Input Capacitor

To limit the input voltage drop during momentary output short-circuit conditions, connect a capacitor no more than 5mm from IN to GND. A 1μF ceramic capacitor will be adequate for most applications; however, higher capacitor values will further reduce the voltage drop at the input.

### Output Capacitor

Connect a 0.1μF capacitor from OUT to GND to prevent inductive parasitics from pulling OUT negative during turn-off.

### Layout and Thermal-Dissipation Considerations

To take full advantage of the switch-response time to output short-circuit conditions, it is very important to keep all traces as short as possible to reduce the effect of undesirable parasitic inductance. Place input and output capacitors as close to the device as possible (no more than 5mm).

Under normal operating conditions, the package can dissipate and channel heat away. Calculate the maximum power as follows:

$$P = (I_{LIMIT})^2 \cdot R_{ON}$$

where  $R_{ON}$  is the on-resistance of the switch.

When the output is short circuited, the voltage drop across the switch equals the input supply. Hence, the power dissipated across the switch increases, as does the die temperature. If the fault condition is not removed, the thermal-shutdown protection circuitry turns the switch off until the die temperature falls by 10°C. A ground plane in contact with the device will help dissipate additional heat.

## Chip Information

TRANSISTOR COUNT: 340

# 1.2A, Current-Limited, High-Side P-Channel Switch with Thermal Shutdown

## Package Information

	INCHES		MILLIMETERS	
	MIN	MAX	MIN	MAX
A	0.053	0.069	1.35	1.75
A1	0.004	0.010	0.10	0.25
B	0.014	0.019	0.35	0.49
C	0.007	0.010	0.19	0.25
e	0.050		1.27	
E	0.150	0.157	3.80	4.00
H	0.228	0.244	5.80	6.20
h	0.010	0.020	0.25	0.50
L	0.016	0.050	0.40	1.27

	INCHES		MILLIMETERS		N	MS012
	MIN	MAX	MIN	MAX		
D	0.189	0.197	4.80	5.00	8	A
D	0.337	0.344	8.55	8.75	14	B
D	0.386	0.394	9.80	10.00	16	C

NOTES:  
 1. D&E DO NOT INCLUDE MOLD FLASH  
 2. MOLD FLASH OR PROTRUSIONS NOT TO EXCEED .15mm (.006")  
 3. LEADS TO BE COPLANAR WITHIN .102mm (.004")  
 4. CONTROLLING DIMENSION: MILLIMETER  
 5. MEETS JEDEC MS012-XX AS SHOWN IN ABOVE TABLE  
 6. N = NUMBER OF PINS

MAXIM  
 120 SAN GABRIEL DR. SUNNYVALE, CA 94086 FAX (415) 737-7600  
 PROPRIETARY INFORMATION

PACKAGE FAMILY OUTLINE: SOIC .150"

1/1

21-0041 A  
 DOCUMENT CONTROL NUMBER REV

Maxim cannot assume responsibility for use of any circuitry other than circuitry entirely embodied in a Maxim product. No circuit patent licenses are implied. Maxim reserves the right to change the circuitry and specifications without notice at any time.

8 Maxim Integrated Products, 120 San Gabriel Drive, Sunnyvale, CA 94086 408-737-7600