

HSDL-44xx IR Emitter Series

HSDL-54xx IR Detector Series

High-Performance IR Emitter and IR PIN Photodiode in Subminiature SMT Package



Data Sheet



Description

Flat Top Package

The HSDL-4400 Series of flat top IR emitters uses an untinted, nondiffused, truncated lens to provide a wide radiation pattern that is useful for short distance communication where alignment of the emitter and detector is not critical. The HSDL-5400 Series of flat top IR detectors uses the same truncated lens design as the HSDL-4400 Series of IR emitters with the added feature of a black tint that acts as an optical filter to reduce the effects of ambient light, such as sun, incandescent and fluorescent light from interfering with the IR signal.

Dome Package

The HSDL-4420 Series of dome IR emitters uses an untinted, nondiffused lens to provide a 24 degree viewing angle with high on-axis intensity. The HSDL-5420 Series of IR detectors uses the same lens design as the HSDL-4420 IR emitter and optical filter used in the HSDL-5400 IR detector.

Lead Configuration

All of these devices are made by encapsulating LED and PIN photodiode chips on axial lead frames to form molded epoxy subminiature packages. A variety of lead configurations is available and includes: surface mount gull wing, yoke lead, or Z-bend and through hole lead bends at 2.54 mm (0.100 inch) center spacing.

Technology

The subminiature solid state emitters utilize a highly optimized LED material, transparent substrate aluminum gallium arsenide, TS AlGaAs. This material has a very high radiant efficiency, capable of producing high light output over a wide range of drive currents and temperature.

Features

- **Subminiature flat top and dome package**
Size – 2x2 mm
- **IR emitter**
875 nm TS AlGaAs
Intensity – 17 mW/sr
Speed – 40 ns
- **Wide range of drive currents**
500 μ A to 500 mA
- **IR detector**
PIN photodiode
High sensitivity
Speed – 7.5 ns
- **Flexible lead configurations**
Surface mount or through hole

Applications

- **Short distance IR links**
- **IrDA compatible**
- **Small handheld devices**
Pagers
Industrial handhelds
- **Diffuse LANs**
- **Wireless audio**

Device Selection Guide

IR Emitters

Part Number	Device Description ^[1]	Device Outline Drawing
HSDL-4400	LED, Flat Top, 110 deg	A
HSDL-4420	LED, Dome, 24 deg	B

IR Detectors

Part Number	Device Description ^[1]	Device Outline Drawing
HSDL-5400	PIN Photodiode, Flat Top, 110 deg	C
HSDL-5420	PIN Photodiode, Dome, 28 deg	D

Package Configuration Options

Option Code	Package Configuration Description		Package Outline Drawing	
011	Gull Wing Lead, Tape and Reel ^[2]		E, J, M	
021	Yoke Lead, Tape and Reel ^[2]	Surface Mount Lead	F, K, M	
031	Z-Bend, Tape and Reel ^[2]		G, L, M	
1L1	2.54 mm (0.100 in) Center Lead Spacing	Long Leads; 10.4 mm (0.410 in)	Thru Hole Lead	H
1S1		Short Leads; 3.7 mm (0.145 in)		I
No Option	Straight Leads ^[3]		Prototyping	A, B, C, D

Notes:

1. IR Emitters have untinted, nondiffused lenses and IR Detectors have black tinted, nondiffused lenses.
2. Emitters and detectors are supplied in 12 mm embossed tape on 178 mm (7 inch) diameter reels, with 1500 units per reel. Minimum order quantity and order increment are in quantity of reels only.
3. Emitters and detectors are supplied in bulk form in bags of 50 units.
4. The HSDL-44xx and HSDL-54xx families are not designed to be used in medical devices with life support functions or in safety equipment (or similar applications where components failures would result in loss of life or physical harm), eg. in automotive, medical or airline industries.

Package Dimensions
(A) Flat Top Emitters

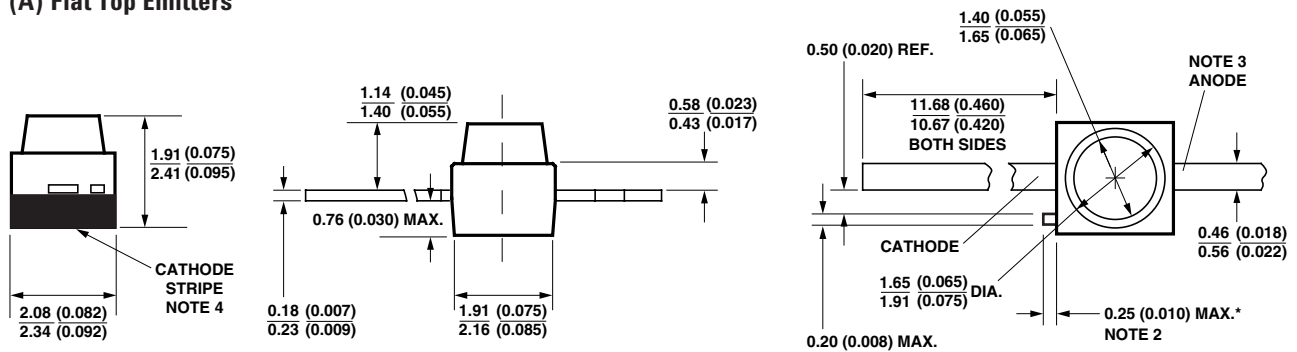

(B) Dome Emitters

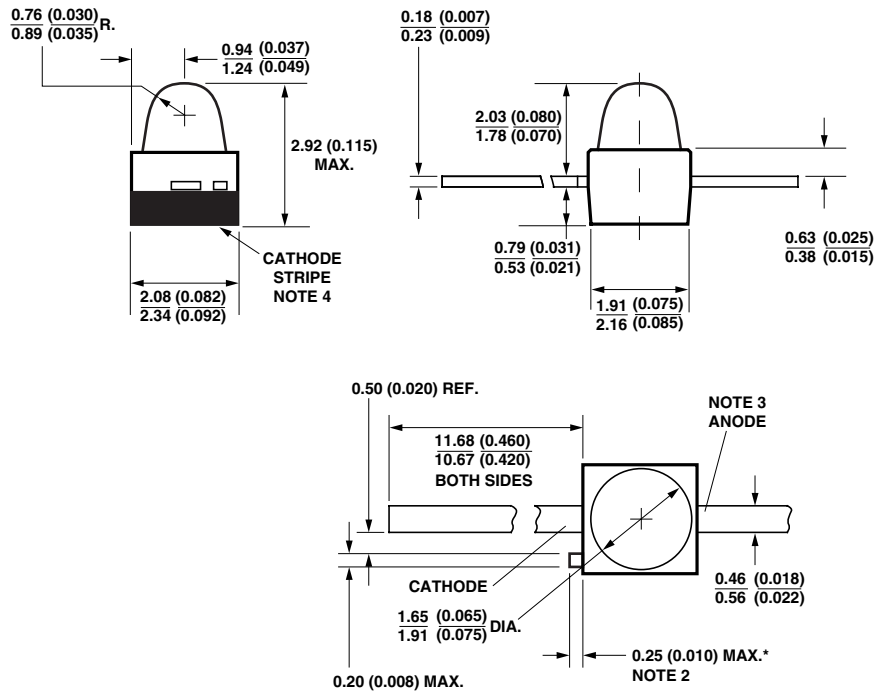

NOTES:

1. ALL DIMENSIONS ARE IN MILLIMETRES (INCHES).
2. PROTRUDING SUPPORT TAB IS CONNECTED TO ANODE LEAD.
3. LEAD POLARITY FOR THESE TS AlGaAs SUBMINIATURE LAMPS IS OPPOSITE TO THE LEAD POLARITY OF SUBMINIATURE LAMPS USING OTHER LED TECHNOLOGIES.
4. CATHODE STRIPE MARKING IS DARK BLUE.

(C) Flat Top Detectors

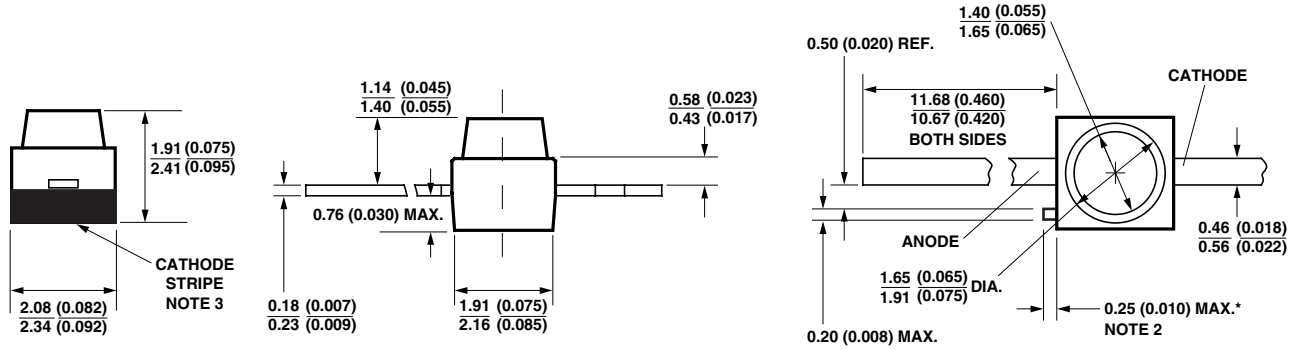

(D) Dome Detectors

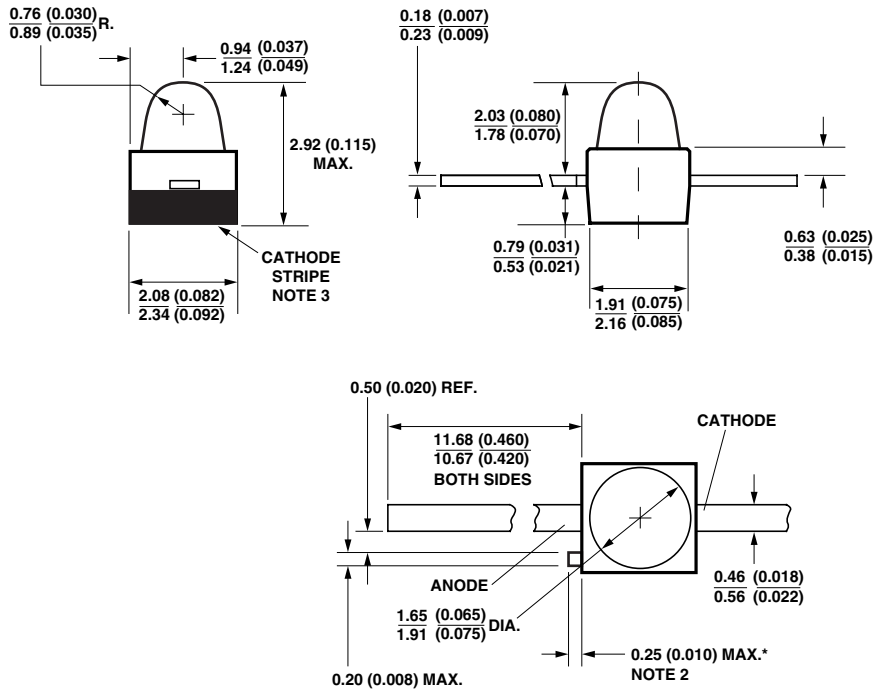

NOTES:

1. ALL DIMENSIONS ARE IN MILLIMETRES (INCHES).
2. PROTRUDING SUPPORT TAB IS CONNECTED TO CATHODE LEAD.
3. CATHODE STRIPE MARKING IS DARK BLUE.

Package Dimensions

The following notes affect the package outline drawings E through I.

reversed for the HSDL-44xx IR emitters where the protruding support tab is closest to the cathode lead.

1. The pinout represents the HSDL-54xx IR detectors where the protruding support tab is closest to the anode lead. While the pinout is
2. The protruding support tab of the HSDL-54xx is connected to the cathode lead. While the protruding support tab of the HSDL-44xx is connected to the anode lead.

(E) Gull Wing Lead, Option 011

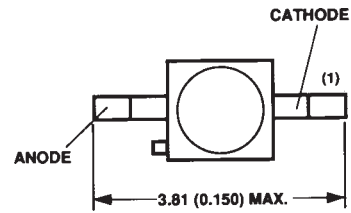
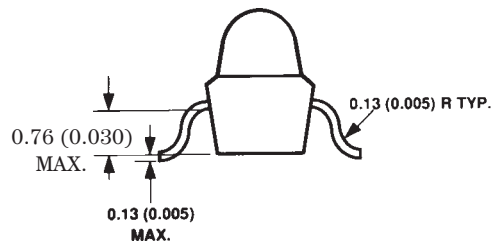
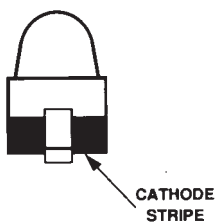

ALL DIMENSIONS ARE IN MILLIMETRES (INCHES)

(F) "Yoke" Lead, Options 021

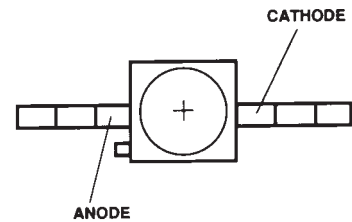
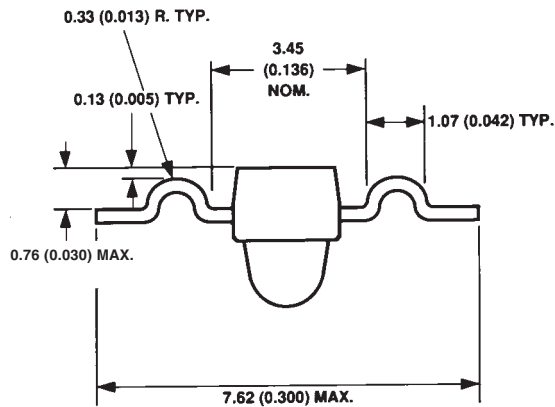
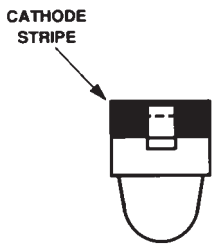

(0.013) R. TYP.

ALL DIMENSIONS ARE IN MILLIMETRES (INCHES)

(G) Z-Bend Lead, Options 031

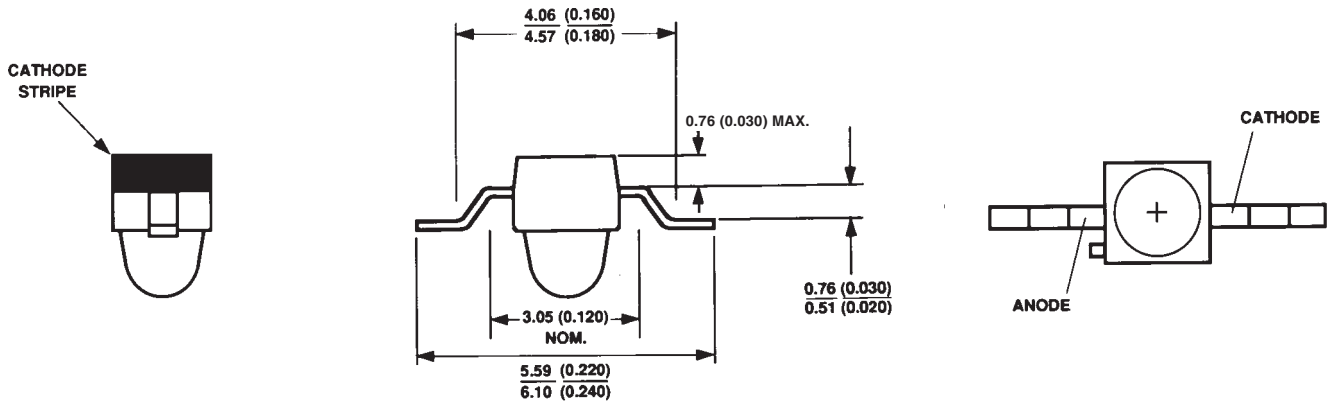

ALL DIMENSIONS ARE IN MILLIMETRES (INCHES)

(H) Thru Hole Lead Option 1L1

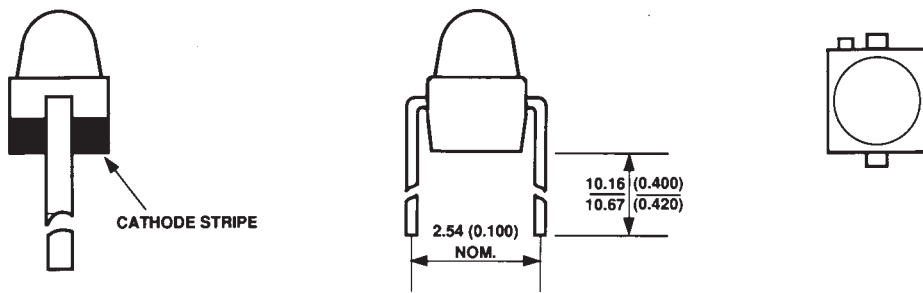

ALL DIMENSIONS ARE IN MILLIMETRES (INCHES)

(I) Thru Hole Lead Option 1S1

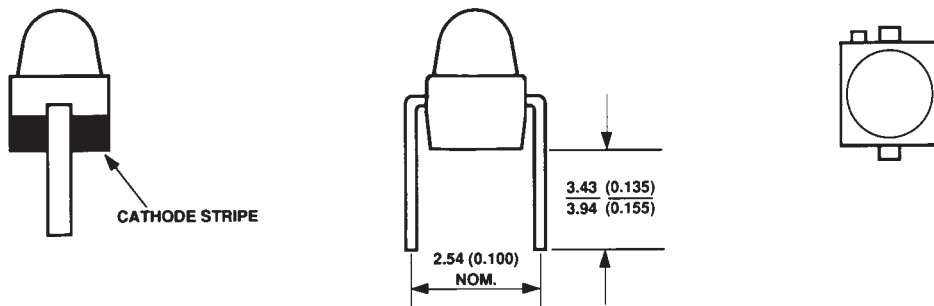

ALL DIMENSIONS ARE IN MILLIMETRES (INCHES)

Package Dimensions: Surface Mount Tape and Reel Options
(J) 12 mm Tape and Reel, Gull Wing Lead, Option 011

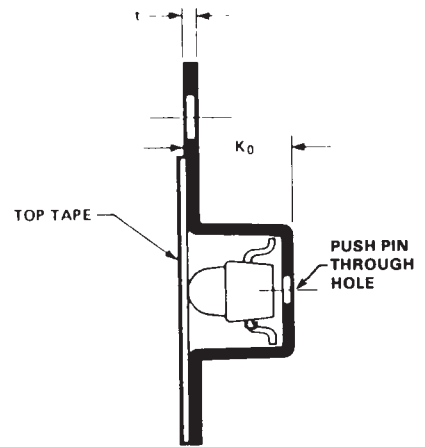
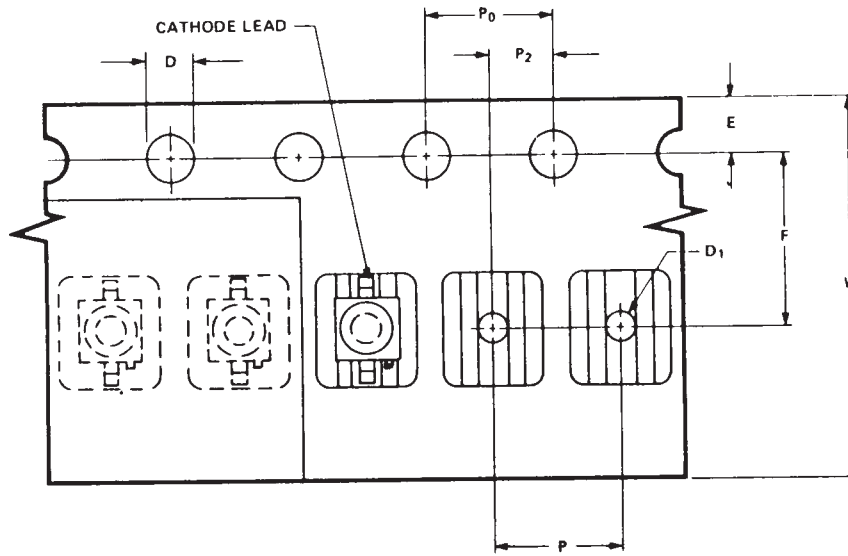

GULL WING LEAD
SUBMINIATURE PACKAGE

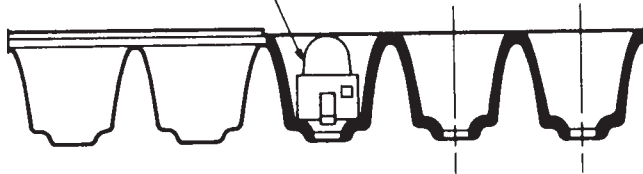

NOTES:

1. EMPTY COMPONENT POCKETS SEALED WITH TOP COVER TAPE.
2. 7 INCH REEL – 1500 PIECES PER REEL.
3. MINIMUM LEADER LENGTH AT EITHER END OF THE TAPE IS 500 mm.
4. THE MAXIMUM NUMBER OF CONSECUTIVE MISSING DEVICES IS TWO.
5. IN ACCORDANCE WITH ANSI/EIA RS-481 SPECIFICATIONS, THE CATHODE IS ORIENTED TOWARDS THE TAPE SPROCKETS HOLE.

(K) 12 mm Tape and Reel, "Yoke" Lead, Option 021

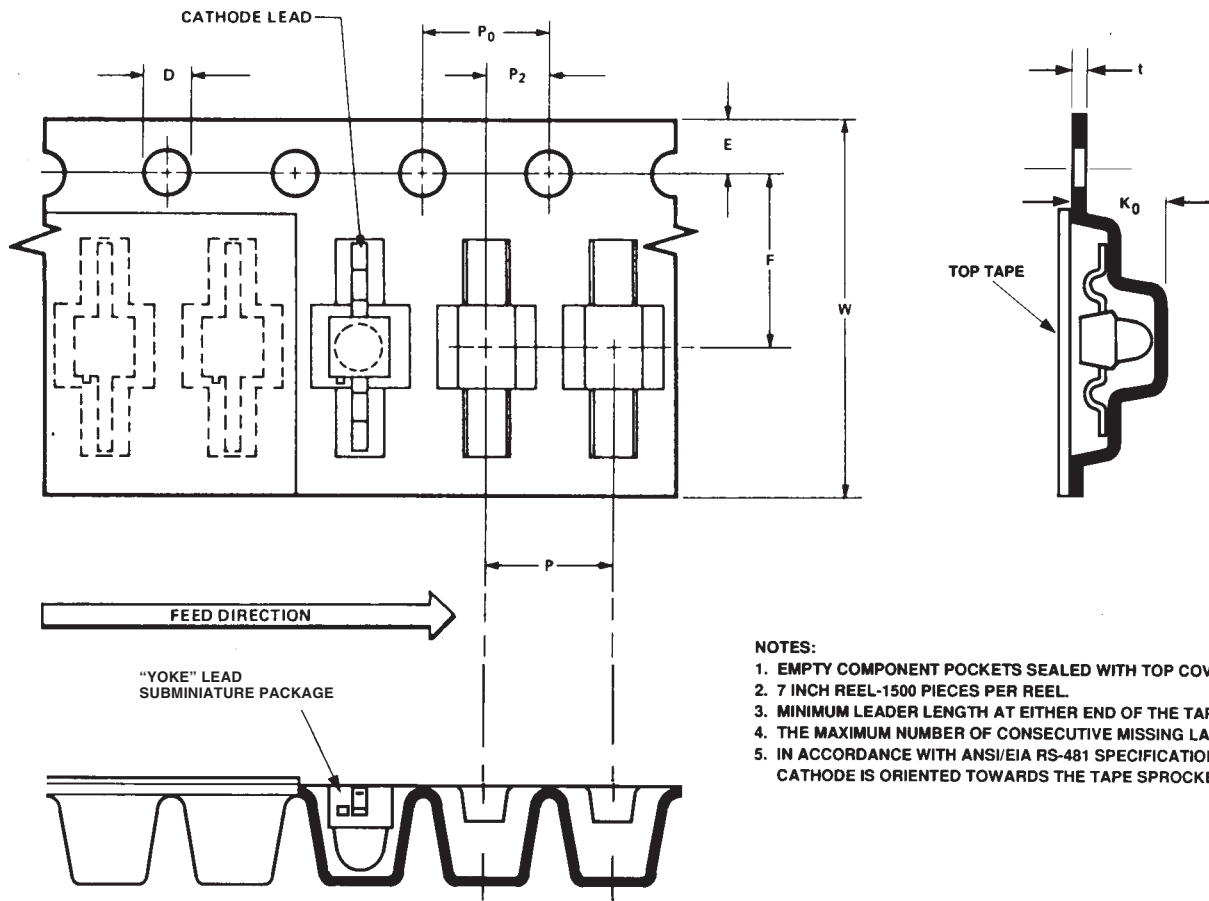

NOTES:

1. EMPTY COMPONENT POCKETS SEALED WITH TOP COVER TAPE.
2. 7 INCH REEL-1500 PIECES PER REEL.
3. MINIMUM LEADER LENGTH AT EITHER END OF THE TAPE IS 500 mm.
4. THE MAXIMUM NUMBER OF CONSECUTIVE MISSING LAMPS IS TWO.
5. IN ACCORDANCE WITH ANSI/EIA RS-481 SPECIFICATIONS, THE CATHODE IS ORIENTED TOWARDS THE TAPE SPROCKET HOLE.

(L) 12 mm Tape and Reel, Z-Bend Lead, Option 031

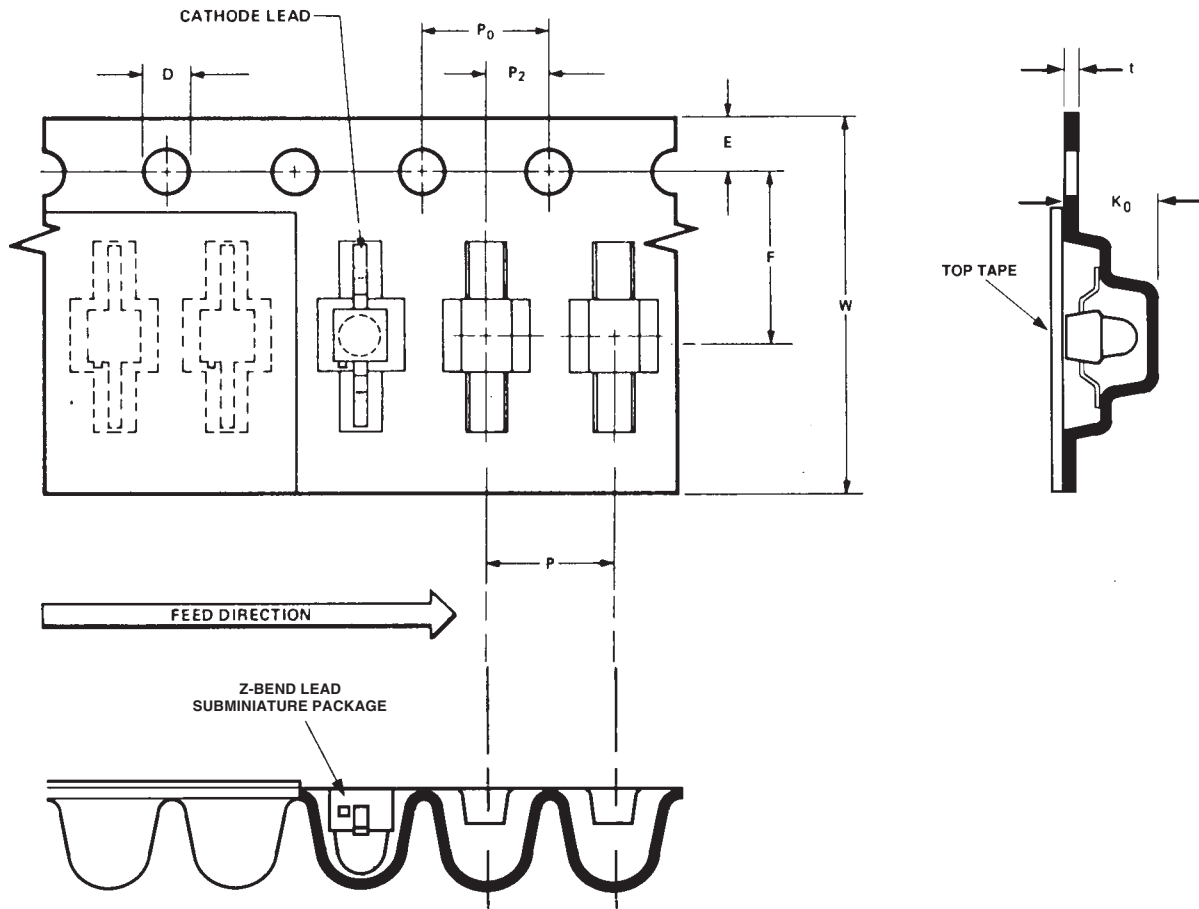

(M) 12 mm Tape and Reel

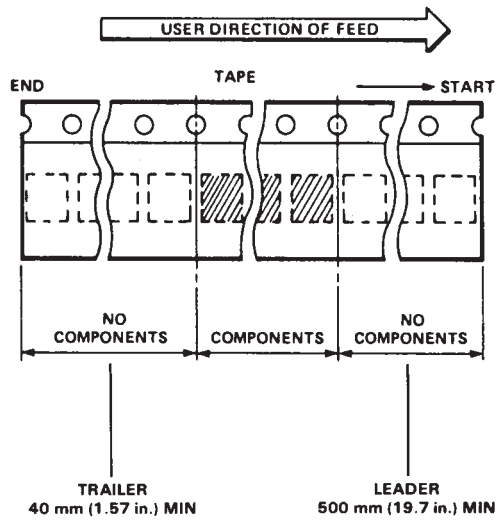

TOLERANCES (UNLESS OTHERWISE SPECIFIED):
 .X ± .1; .XX ± .05 (.XXX ± .004)

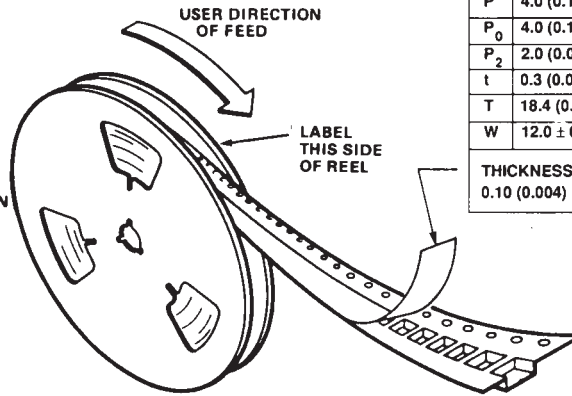

DIMENSIONS PER ANSI/EIA
 STANDARD RS-481.
 ALL DIMENSIONS ARE IN
 MILLIMETRES (INCHES).

A	178.0 ± 2.0 (7.0 ± 0.08) DIA.
C	13.0 (0.512) DIA. TYP.
D	1.55 (0.061 ± 0.002) DIA.
D ₁	1.0 (0.039) DIA. MIN.
D ₂	20.2 (0.795) DIA. MIN.
E	1.75 ± 0.1 (0.069)
F	5.50 (0.127 ± 0.002)
K ₀	3.05 ± 0.1 (0.120) TYP.
N	50.0 (1.970) MIN.
P	4.0 (0.157) TYP.
P ₀	4.0 (0.157) TYP.
P ₂	2.0 (0.079 ± 0.002) TYP.
t	0.3 (0.012) TYP.
T	18.4 (0.72) MAX.
W	12.0 ± 0.3 (0.472 ± 0.012)

THICKNESS OF TOP COVER TAPE
 0.10 (0.004) MAX.

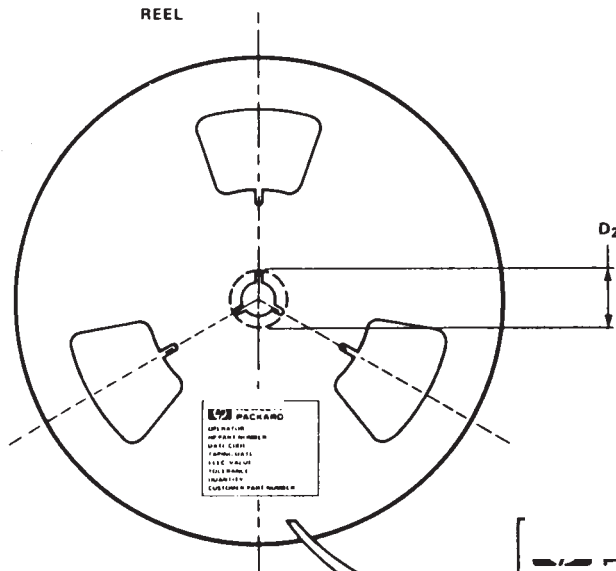

HP PACKARD

OPERATOR _____
 HP PART NUMBER _____
 DATE CODE _____
 TAPING DATE _____
 ELEC. VALUE _____
 TOLERANCE _____
 QUANTITY _____
 CUSTOMER PART NUMBER _____

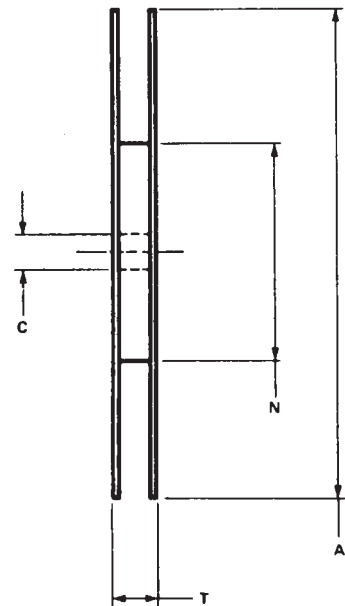

Convective IR Reflow Soldering

For information on IR reflow soldering, refer to Application Note 1060, Surface Mounting SMT LED Components.

HSDL-44xx Absolute Maximum Ratings

Parameter	Symbol	Min.	Max.	Unit	Ref.
Peak Forward Current (Duty Factor = 20%, Pulse Width = 100 μ s)	I_{FPK}		500	mA	Fig. 7, 8
DC Forward Current	I_{FDC}		100	mA	Fig. 6
Power Dissipation	P_{DISS}		100	mW	
Reverse Voltage ($I_R = 100 \mu$ A)	V_R	5		V	
Transient Forward Current (10 μ s Pulse)	I_{FTR}		1.0	A	[1]
Operating Temperature	T_O	-40	85	$^{\circ}$ C	
Storage Temperature	T_S	-55	100	$^{\circ}$ C	
Junction Temperature	T_J		110	$^{\circ}$ C	
Lead Solder Temperature [1.6 mm (0.063 in.) from body]			260/5 s	$^{\circ}$ C	
Reflow Soldering Temperatures					
Convection IR			235/90 s	$^{\circ}$ C	Fig. 20
Vapor Phase			215/180 s	$^{\circ}$ C	

Note:

1. The transient peak current in the maximum nonrecurring peak current the device can withstand without damaging the LED die and the wire bonds.

HSDL-44xx Electrical Characteristics at $T_A = 25^{\circ}$ C

Parameter	Symbol	Min.	Typ.	Max.	Unit	Condition	Ref.
Forward Voltage	V_F	1.30	1.50 2.15	1.70	V	$I_{FDC} = 50$ mA $I_{FPK} = 250$ mA	Fig. 2
Forward Voltage Temperature Coefficient	$\Delta V_F / \Delta T$		-2.1 -2.1		mV/ $^{\circ}$ C	$I_{FDC} = 50$ mA $I_{FDC} = 100$ mA	Fig. 3
Series Resistance	R_S		2		Ω	$I_{FDC} = 100$ mA	
Diode Capacitance	C_O		50		pF	0 V, 1 MHz	
Reverse Voltage	V_R	5	20		V	$I_R = 100 \mu$ A	
Thermal Resistance, Junction to Pin	$R\theta_{jp}$		170		$^{\circ}$ C/W		

HSDL-44XX Optical Characteristics at $T_A = 25^\circ\text{C}$

Parameter	Symbol	Min.	Typ.	Max.	Unit	Condition	Ref.
Radiant On-Axis Intensity							
HSDL-4400	I_E	1	3 6 15	8	mW/sr	$I_{FDC} = 50\text{ mA}$ $I_{FDC} = 100\text{ mA}$ $I_{FPK} = 250\text{ mA}$	Fig. 4, 5
HSDL-4420	I_E	9	17 32 85	30	mW/sr	$I_{FDC} = 50\text{ mA}$ $I_{FDC} = 100\text{ mA}$ $I_{FPK} = 250\text{ mA}$	Fig. 4, 5
Radiant On-Axis Intensity Temperature Coefficient	$\Delta I_E / \Delta T$		-0.35 -0.35		%/ $^\circ\text{C}$	$I_{FDC} = 50\text{ mA}$ $I_{FDC} = 100\text{ mA}$	
Viewing Angle							
HSDL-4400	$2\theta_{1/2}$		110		deg	$I_{FDC} = 50\text{ mA}$	Fig. 9
HSDL-4420	$2\theta_{1/2}$		24		deg	$I_{FDC} = 50\text{ mA}$	Fig. 10
Peak Wavelength	λ_{PK}	850	875	900	nm	$I_{FDC} = 50\text{ mA}$	Fig. 1
Peak Wavelength Temperature Coefficient	$\Delta\lambda / \Delta T$		0.25		nm/ $^\circ\text{C}$	$I_{FDC} = 50\text{ mA}$	
Spectral Width at FWHM	$\Delta\lambda$		37		nm	$I_{FDC} = 50\text{ mA}$	Fig. 1
Optical Rise and Fall Times, 10%-90%	t_r / t_f		40		ns	$I_{FPK} = 50\text{ mA}$	
Bandwidth	f_c		9		MHz	$I_{FDC} = 50\text{ mA}$ $\pm 10\text{ mA}$	Fig. 11

HSDL-54xx Absolute Maximum Ratings

Parameter	Symbol	Min.	Max.	Unit
Power Dissipation	P_{DISS}		150	mW
Reverse Voltage ($I_R = 100 \mu A$)	V_R		40	V
Operating Temperature	T_O	-40	85	°C
Storage Temperature	T_S	-55	100	°C
Junction Temperature	T_J		110	°C
Lead Solder Temperature [1.6 mm (0.063 in.) from body]			260/5 s	°C
Reflow Soldering Temperatures				
Convection IR			235/90 s	°C
Vapor Phase			215/180 s	°C

HSDL-54xx Electrical Characteristics at $T_A = 25^\circ C$

Parameter	Symbol	Min.	Typ.	Max.	Unit	Condition	Ref.
Forward Voltage	V_F		0.8		V	$I_{FDC} = 1 \text{ mA}$	
Breakdown Voltage	V_{BR}			40	V	$I_R = 100 \mu A$, $E_e = 0 \text{ mW/cm}^2$	
Reverse Dark Current	I_D		1	5	nA	$V_R = 5 \text{ V}$, $E_e = 0 \text{ mW/cm}^2$	Fig. 12
Series Resistance	R_S		2000		Ω	$V_R = 5 \text{ V}$, $E_e = 0 \text{ mW/cm}^2$	
Diode Capacitance	C_0		5		pF	$V_R = 0 \text{ V}$, $E_e = 0 \text{ mW/cm}^2$ $f = 1 \text{ MHz}$	Fig. 16
Open Circuit Voltage	V_{OC}		375		mV	$E_e = 1 \text{ mW/cm}^2$ $\lambda_{PK} = 875 \text{ nm}$	
Temperature Coefficient of V_{OC}	$\Delta V_{OC}/\Delta T$		-2.2		mV/K	$E_e = 1 \text{ mW/cm}^2$ $\lambda_{PK} = 875 \text{ nm}$	
Short Circuit Current	I_{SC}					$E_e = 1 \text{ mW/cm}^2$ $\lambda_{PK} = 875 \text{ nm}$	
HSDL-5400			1.6		μA		
HSDL-5420			4.3		μA		
Temperature Coefficient of I_{SC}	$\Delta I_{SC}/\Delta T$		0.16		%/K	$E_e = 1 \text{ mW/cm}^2$ $\lambda_{PK} = 875 \text{ nm}$	
Thermal Resistance, Junction to Pin	$R\theta_{jP}$		170		°C/W		

HSDL-54xx Optical Characteristics at $T_A = 25^\circ\text{C}$

Parameter	Symbol	Min.	Typ.	Max.	Unit	Condition	Ref.
Photocurrent						$E_e = 1 \text{ mW/cm}^2$	Fig. 14,
HSDL-5400	I_{PH}	0.8	1.6		μA	$\lambda_{PK} = 875 \text{ nm}$	15
HSDL-5420		3.0	6.0			$V_R = 5 \text{ V}$	
Temperature Coefficient of I_{PH}	$\Delta I_{PH}/\Delta T$		0.1		$\%/K$	$E_e = 1 \text{ mW/cm}^2$ $\lambda_{PK} = 875 \text{ nm}$ $V_R = 5 \text{ V}$	Fig. 13
Radiant Sensitive Area	A		0.15		mm^2		
Absolute Spectral Sensitivity	S		0.5		A/W	$E_e = 1 \text{ mW/cm}^2$ $\lambda_{PK} = 875 \text{ nm}$ $V_R = 5 \text{ V}$	
Viewing Angle							
HSDL-5400	$2\theta_{1/2}$		110		deg		Fig. 18
HSDL-5420			28				Fig. 19
Wavelength of Peak Sensitivity	λ_{PK}		875		nm	$E_e = 1 \text{ mW/cm}^2$ $V_R = 5 \text{ V}$	Fig. 17
Spectral Bandwidth	$\Delta\lambda$		770- 1000		nm	$E_e = 1 \text{ mW/cm}^2$ $V_R = 5 \text{ V}$	Fig. 17
Quantum Efficiency	η		70		%	$E_e = 1 \text{ mW/cm}^2$ $\lambda_{PK} = 875 \text{ nm}$, $V_R = 5 \text{ V}$	
Noise Equivalent Power	NEP		$6.2 \times$ 10^{-15}		$\text{W/Hz}^{1/2}$	$V_R = 5 \text{ V}$ $\lambda_{PK} = 875 \text{ nm}$	
Detectivity	D		$6.3 \times$ 10^{12}		cm^* $\text{Hz}^{1/2}/\text{W}$	$V_R = 5 \text{ V}$ $\lambda_{PK} = 875 \text{ nm}$	
Optical Rise and Fall Times, 10%-90%	t_r/t_f		7.5		ns	$V_R = 5 \text{ V}$ $R_L = 1 \text{ k}\Omega$ $\lambda_{PK} = 875 \text{ nm}$	
Bandwidth	f_c		50		MHz	$V_R = 5 \text{ V}$ $R_L = 1 \text{ k}\Omega$ $\lambda_{PK} = 875 \text{ nm}$	

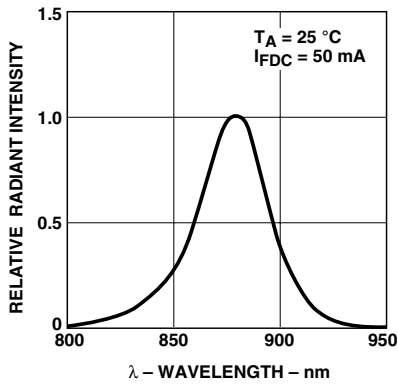

Figure 1. Relative radiant intensity vs. wavelength.

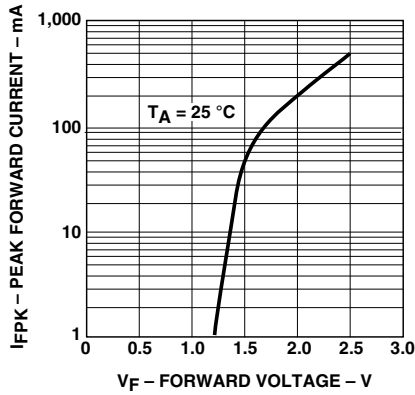

Figure 2. Peak forward current vs. forward voltage.

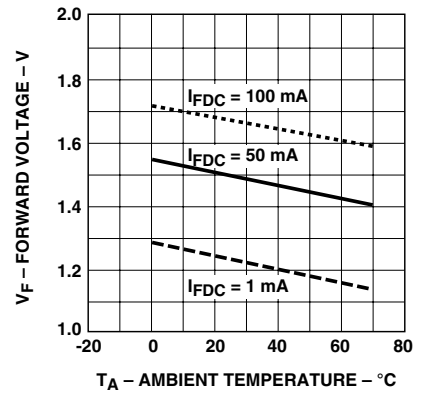

Figure 3. Forward voltage vs. ambient temperature.

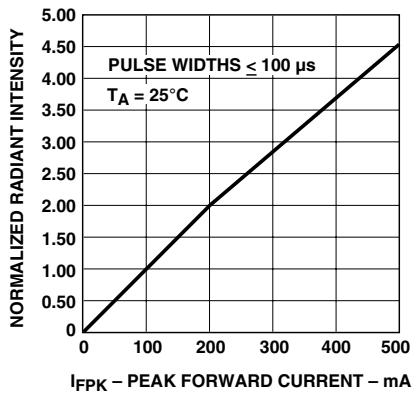

Figure 4. Normalized radiant intensity vs. peak forward current.

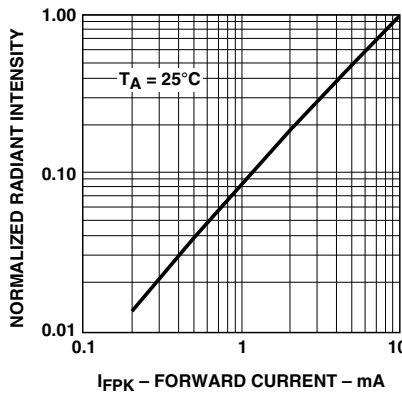

Figure 5. Normalized radiant intensity vs. peak forward current (0 to 10 mA).

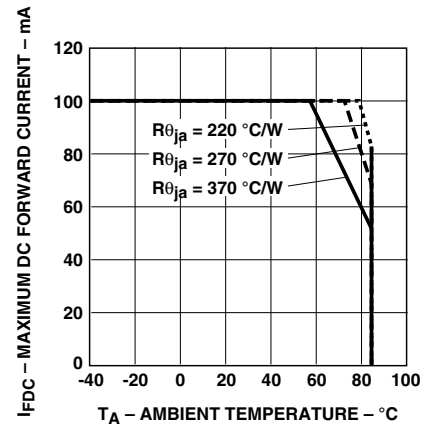

Figure 6. Maximum DC forward current vs. ambient temperature. Derated based on $T_{JMAX} = 110^{\circ}\text{C}$.

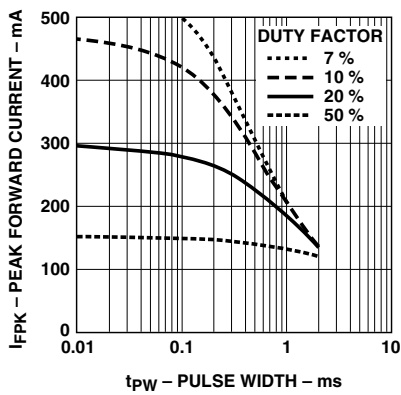

Figure 7. Maximum peak forward current vs. duty factor.

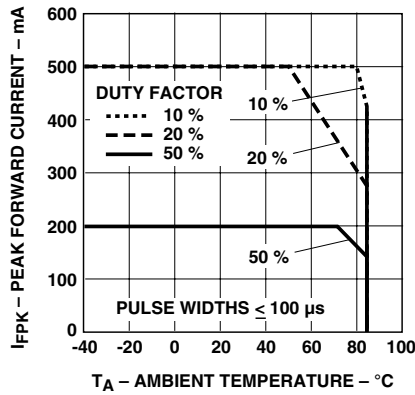

Figure 8. Maximum peak forward current vs. ambient temperature. Derated based on $T_{JMAX} = 110^{\circ}\text{C}$.

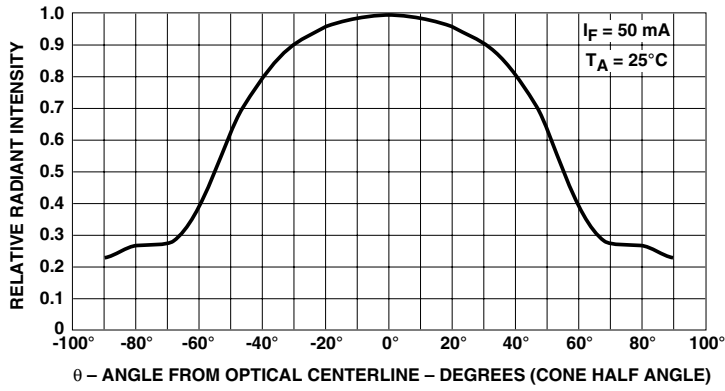

Figure 9. Relative radiant intensity vs. angular displacement HSDL-4400.

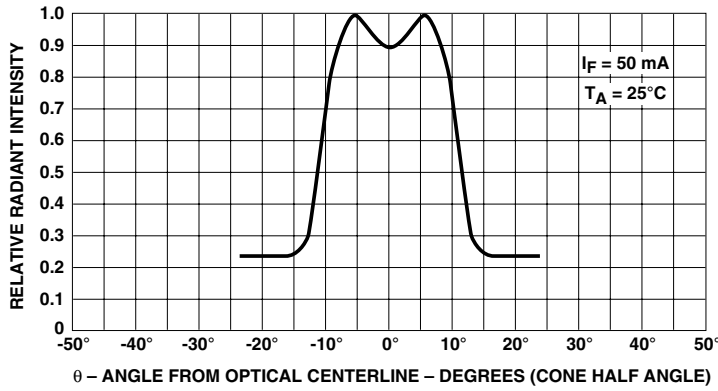

Figure 10. Relative radiant intensity vs. angular displacement HSDL-4420.

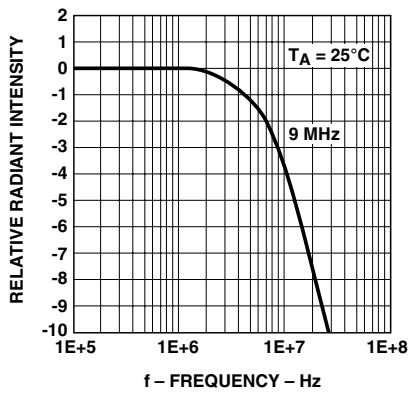

Figure 11. Relative radiant intensity vs. frequency.

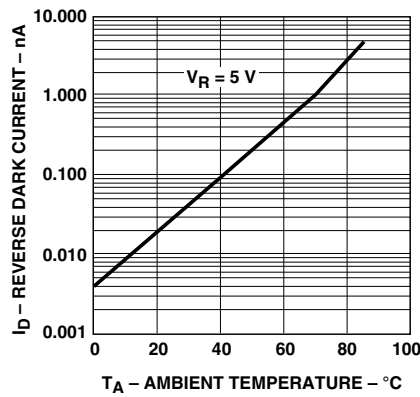

Figure 12. Reverse dark current vs. ambient temperature.

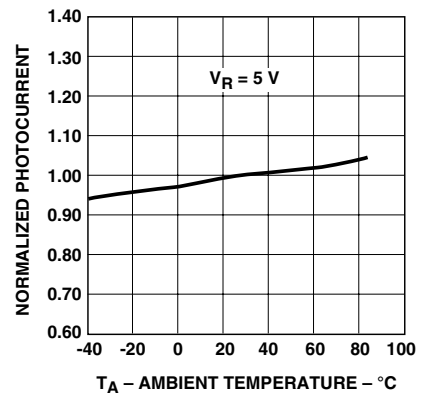

Figure 13. Relative reverse light current vs. ambient temperature.

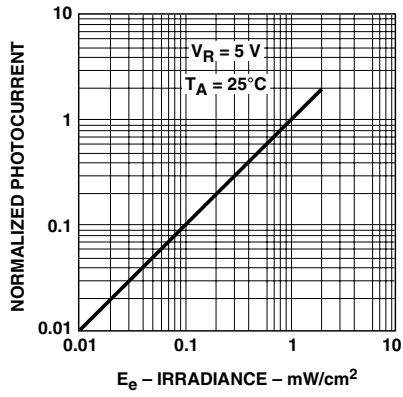

Figure 14. Reverse light current vs. irradiance

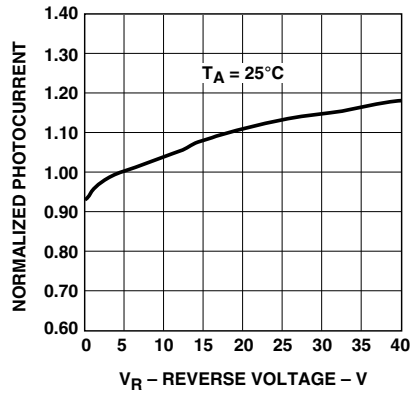

Figure 15. Reverse light current vs. reverse voltage.

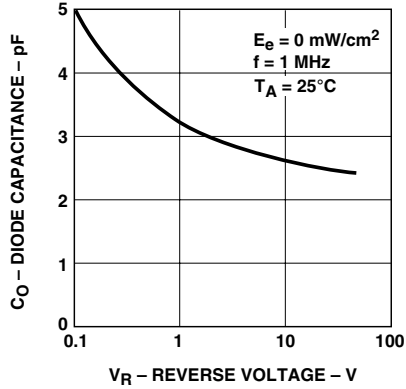

Figure 16. Diode capacitance vs. reverse voltage.

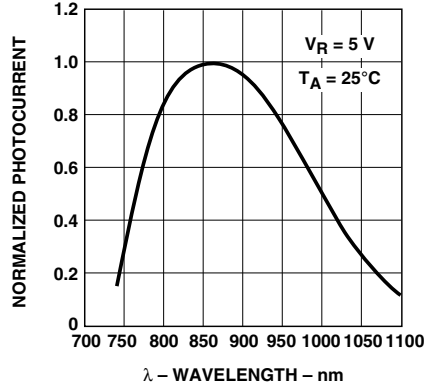

Figure 17. Relative spectral sensitivity vs. wavelength.

At the time of this publication, Light Emitting Diodes (LEDs) that are contained in this product are regulated for eye safety in Europe by the Commission for European Electrotechnical Standardization (CENELEC) EN60825-1. Please refer to Application Brief I-008 for more information.

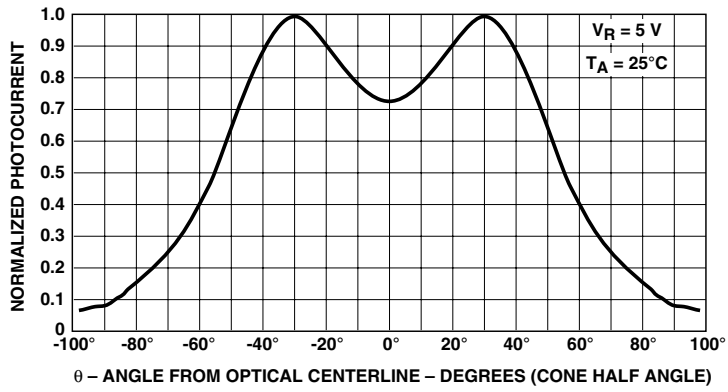

Figure 18. Relative radiant intensity vs. angular displacement.
HSDL-5400.

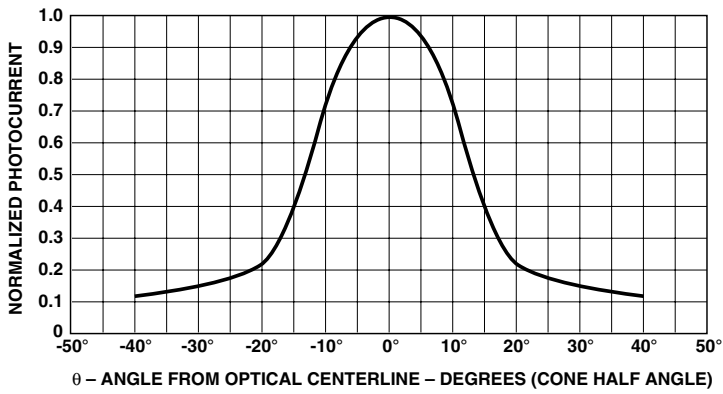
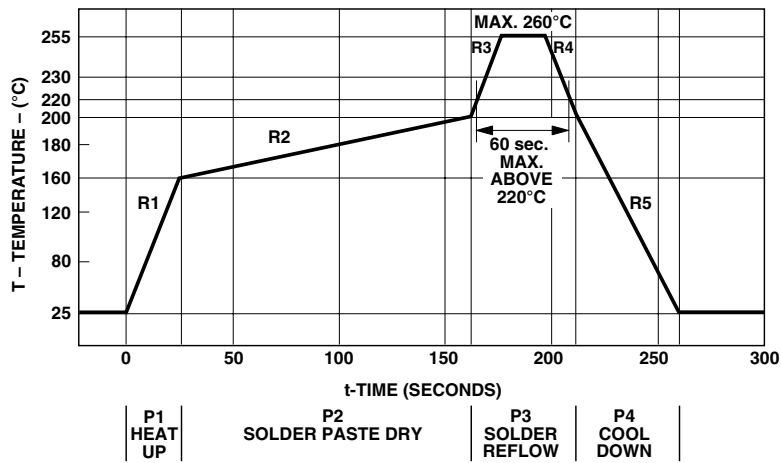

Figure 19. Relative radiant intensity vs. angular displacement.
HSDL-5420.



Process Zone	Symbol	ΔT	Maximum $\Delta T/\Delta time$
Heat Up	P1, R1	25°C to 160°C	4°C/s
Solder Paste Dry	P2, R2	160°C to 200°C	0.5°C/s
Solder Reflow	P3, R3	200°C to 255°C (260°C at 10 seconds max)	4°C/s
	P3, R4	255°C to 200°C	-6°C/s
Cool Down	P4, R5	200°C to 25°C	-6°C/s

Figure 20. Evaluation soldering profiles (polyled).

For company and product information, please go to our web site: [WWW.liteon.com](http://www.liteon.com) or <http://optodatabook.liteon.com/databook/databook.aspx>

Data subject to change. Copyright © 2007 Lite-On Technology Corporation. All rights reserved.

LITEON®