

Cable Accessory Products

Splice Rejacketing	387
Splice Repair	390
3M™ Safety Sock Grounding Kits, Shielded and Jacketed URD Cable	391
Sealing and Grounding	393
3/C Cable Breakout Boots and 3/C Phase Rejacketing System	395
Insulating and Sealing Compounds	408
Mounting Brackets	410
3M™ Cold Shrink Corrosion Protection Kit CPT Series	411
Preparation and Cleaning	413
3M™ Electrostatic Animal Guard	415
Overhead Conductor Animal Guard Cover	416



Offers accessory products to assist with splice rejacketing, cable jacket sealing, grounding and cable preparation. Many of the products shown here are used with 3M splices and terminations. Remember to reference those sections for more product information.

Complete care
for any
kind of cable



Splice Rejacketing

When jacketed concentric neutral cable (JCN) is spliced, it is necessary to cover the junction between the cable jackets with a water resistant re-jacket. 3M offers three designs for splice re-jacketing: cold shrink one piece sleeve, cold shrink stacked sleeve, and heat shrink adhesive-lined sleeves.

3M™ Cold Shrink Splice Jacket Kits SJ-1A, SJ-2A, SJ-3A

Cold shrink jacket kits offer advanced, one-piece, water-tight re-jacketing for JCN cable splices. Designed as an accessory kit to re-jacket over molded rubber splices, the SJ Series is made from durable EPDM rubber.

3M Cold Shrink jacket kits SJ-1A, SJ-2A and SJ-3A offer advanced, one-piece, water-tight re-jacketing for JCN shielded power cable splices. The SJ series accommodates voltage classifications of 15 kV, 25 kV and 35 kV.

In addition to the open-ended, tubular rubber sleeve, each kit includes Scotch® Rubber Mastic Tape, which is used to adjust cable O.D. and provide a sure, long-lasting seal between the cable jacket and the cold shrink sleeve, as well as sealing around the cable ground conductor.

This unique, cold shrink re-jacketing kit eliminates the need for dangerous torches or special tooling.

Each kit jackets one splice.

3M™ Cold Shrink SJ-SS Series Stacked Sleeve Splice Jacket Kits SJ-1SS, SJ-2SS, SJ-3SS

Cold Shrink Jacket Kits SJ-1SS, SJ-2SS and SJ-3SS are two-piece, water tight re-jacketing kits for JCN cables.

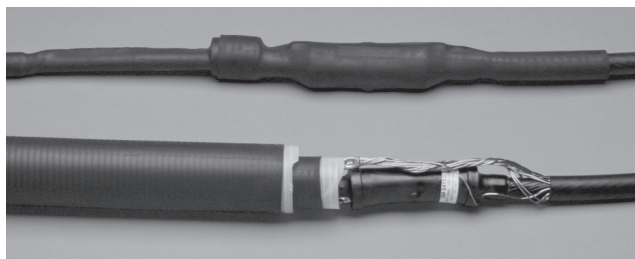

3M™ Cold Shrink SJ-SS Series Stacked Sleeve Splice Jacket Kits SJ-1SS, SJ-2SS, SJ-3SS

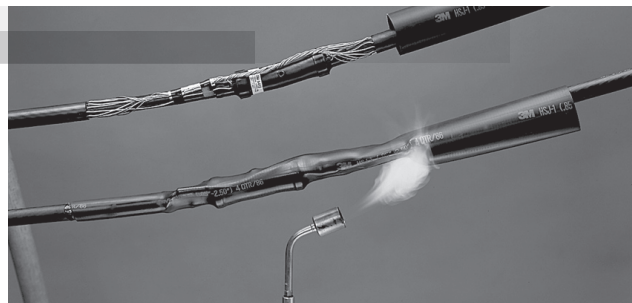

3M™ Heat Shrinkable Splice Jacket Kits HSJ Series

Designed to re-jacket molded rubber splices, the SJ-SS Series kits are made of EPDM rubber. This unique two-piece design allows the two tubes to “stack” on top of each other during installation, requiring less space in the manhole or ditch to make the splice. Each kit contains one small cold shrink tube, one large cold shrink tube, one profile bushing and one roll of Scotch® Mastic Tape 2228. SJ-1SSR and SJ-2SSR are specially sized for repair splices.

Each kit jackets one splice.

3M™ Cold Shrink Foldback Splice Jacket Kits SJ-FB

3M Cold Shrink Foldback Splice Jacket Kits SJ-FB Series are a series of folded back, tubular rubber sleeves that combined with Scotch® Rubber Mastic Tape 2228 provide a sealed jacket over cable splices installed on jacketed power cable. These kits are similar to the FB tubes in the 3M Cold Shrink QS III splice kits.

The Scotch Rubber Mastic Tape 2228 provides for an assured sealing interface between the cable jacket and Cold Shrink Foldback Jacket Tube. Mastic strips are also used to seal around the optional, external ground conductor.

The jacketing tube is made from EPDM rubber that contains no chlorides or sulfurs. The completed jacket tube will be continuous from cable jacket to cable jacket, with no seams.

Four kit sizes cover an application range from 4 AWG, 15 kV to sizes larger than 4/0 AWG, 35 kV.

3M™ Heat Shrinkable Splice Jacket Kits HSJ Series

HSJ Series Heat Shrinkable Splice Jackets are adhesive lined for water-tight re-jacketing of JCN cable splices.

Each kit covers one splice.

Applications:

- To jacket inline splices installed on JCN cable and other jacketed power cables with continuous operating temperature of up to 105° C and an emergency overload temperature rating up to 140° C
- For use in indoor or outdoor installations including direct burial, aerial, and submersible applications
- Physical protection and moisture sealing of inline splices installed on shielded power cables having a solid dielectric insulation

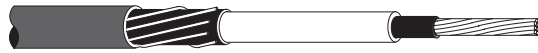

Jacketed Concentric Neutral Cable (JCN)

Specifications and Ordering Information for 3M™ Splice Jacket Kits

Product Number	UPC (054007-)	Sleeve Length	Expanded Sleeve I.D.	Min. Cable Jacket O.D.	Max. Cable Splice O.D.	Max. Cable Jacket Opening	Splice Kit Product No.			Case Qty.
							15 kV	25 kV	35 kV	
3M COLD SHRINK SJ SERIES JACKET KITS FOR 15 KV, 25 KV AND 35 KV										
SJ-1A	69742	28" (711,2 mm)	2.7" (68,5 mm)	0.95" (24,1 mm)	2.4" (61,0 mm)	20" (508 mm)	5411	—	—	6
							5411A 5411R* 5412			
SJ-2A	69743	36" (914,4 mm)	3.7" (93,9 mm)	1.15" (29,2 mm)	3.3" (83,8 mm)	28" (711 mm)	5403	5420	5432	6
							5404	5421	5461	
							5405	5422		
							5406	5451		
								5451A 5452		
SJ-3A	69744	38" (965,2 mm)	4.3" (109,2 mm)	1.55" (39,4 mm)	4.0" (101,6 mm)	30" (762 mm)	5407	5423	5433	6
							5408	5424		
							5409	5425		
								5426		
3M COLD SHRINK SJ-FB SERIES JACKET KITS FOR 15 KV, 25 KV AND 35 KV										
SJ-1FB	55302	—	—	0.95" (24,1 mm)	2.00" (50,8 mm)	25" (63,5 mm)	5411	—	—	6
							5411A 5412			
SJ-2FB	55303	—	—	1.15" (29,2 mm)	3.00" (76,2 mm)	31" (78,7 mm)	5403	5420	5432	6
							5404	5421	5461	
							5405	5422		
							5406	5451		
								5451A 5452		
SJ-3FB	55304	—	—	1.55" (39,4 mm)	3.62" (91,9 mm)	34" (86,4 mm)	5407	5423	5433	6
							5408	5424		
							5409	5425		
								5426		
SJ-4FB	55305	—	—	1.75" (44,5 mm)	4.10" (104,1 mm)	32" (81 mm)	—	—	—	6
Note: The above dimensions should be used to determine sizing for non-3M splices.										
3M COLD SHRINK SJ-SS SERIES COLD SHRINK STACKED SLEEVE KITS FOR 15 KV, 25 KV AND 35 KV										
SJ-1SS	50777	15"	2.4"	0.95"	2.4"	23"	5411	—	—	6
		(381,0 mm)	(60,9 mm)	(24,1 mm)	(61,0 mm)	(584 mm)	5411A			
		18" (457,2 mm)	3.1" (78,7 mm)				5412			

*3M 5411R QS-II requires an additional 8428-12 Cold Shrink tube to jacket the splice. The procedure for jacketing the 5411R QS-II is detailed in the SJ-1A kit installation instructions.

Specifications and Ordering Information for 3M™ Splice Jacket Kits

Product Number	UPC (054007-)	Sleeve Length	Expanded Sleeve I.D.	Min. Cable Jacket O.D.	Max. Cable Splice O.D.	Max. Cable Jacket Opening	Splice Kit Product No.			Case Qty.
							15 kV	25 kV	35 kV	
SJ-2SS	50778	19"	3.1"	1.15"	3.3"	31"	5403	5420	5432	6
		(482,6 mm)	(78,7 mm)	(29,2 mm)	(83,8 mm)	(787 mm)	5404	5421	5461	
		24"	3.7"				5405	5422		
		(609,6 mm)	(93,9 mm)				5406	5451		
SJ-3SS	50779	22"	3.7"	1.55"	4.0"	35"	5407	5423	5433	6
		(558,8 mm)	(93,9 mm)	(39,4 mm)	(101,6 mm)	(889 mm)	5408	5424		
		25"	4.3"				5409	5425		
		(635,0 mm)	(109,2 mm)					5426		
3M GOLD SHRINK STACKED SLEEVE REPAIR JACKET KITS FOR 15 KV										
SJ-1SSR	41956	—	—	0.95" (25 mm)	1.95" (49,5 mm)	29" (737 mm)	5411R	—	—	6
SJ-2SSR	41957	—	—	1.15" (29,2 mm)	3.00" (76,2 mm)	37" (940 mm)	5412R 5451R	—	—	6
3M HSJ SERIES HEAT SHRINKABLE SPLICE JACKETS FOR 15 KV, 25 KV AND 35 KV										
HSJ-1	09270	33"	2.5"	0.85"	1.9"	22"	5411	—	—	10
		(84 mm)	(64 mm)	(21,6 mm)	(48,3 mm)	(559 mm)	5411A			
							5411R			
							5412			
HSJ-2	09271	40"	3.0"	1.00"	2.6"	28"	5403	5420	5432	10
		(102 mm)	(76 mm)	(25,4 mm)	(66,0 mm)	(711 mm)	5404	5421	5461	
							5405	5422		
							5406	5451		
							5412R	5451A		
HSJ-3	09272	40"	4.3"	1.50"	3.4"	28"	5407	5423	5433	5
		(102 mm)	(109 mm)	(38,1 mm)	(86,4 mm)	(711 mm)	5408	5424		
							5409	5425		
								25426		

*3M 5411R QS-II requires an additional 8428-12 Cold Shrink tube to jacket the splice. The procedure for jacketing the 5411R QS-II is detailed in the SJ-1A kit installation instructions.

Kit Contents for 3M Splice Jacket Kits

Product Number	SJ-1A	SJ-2A	SJ-3A	SJ-1SS	SJ-2SS	SJ-3SS	HSJ-1	HSJ-2	HSJ-3
Cable Type	Jacketed Concentric Neutral Cable (JCN) See page 385 for cable type illustration.								
Each kit jackets one splice									
	Gold Shrink Jacketing						Heat Shrink Jacketing		
Cold Shrink Tube	1	1	1	2	2	2	—	—	—
Scotch® Rubber Mastic Tape 2228	1	1	1	1	1	1	—	—	—
Heat Shrink Tube	—	—	—	—	—	—	1	1	1
Profile Bushing	—	—	—	1	1	1	—	—	—
Instructions	1	1	1	1	1	1	1	1	1

Splice Repair

3M™ HDCW Wraparound Heat Shrink Cable Repair Sleeves

3M HDCW Heat Shrink Wraparound Cable Repair Sleeves are designed to quickly repair damaged cable jacketing. They may also be used to re-jacket in-line splices. 3M HDCW wrap sleeves can be used as insulation material on cable and splices up to 1000 volts and as jacket repair material on cable up to 35 kV. The design of the wrap sleeve allows it to be installed in tight spaces with ordinary heating equipment such as a torch.

The 3M HDCW cable repair is made from modified cross-linked polyolefin, with a hot-melt adhesive liner on the inner side of the sleeve. Upon heating, the sleeve shrinks and the adhesive melts, creating a water-tight bond between the sleeve and the cable. 3M HDCW Wraparound Cable Repair Sleeves meet ANSI C119.1 requirements. A corrosion proof metal channel is used to close the sleeve during installation.

3M HDCW wrap sleeves are stocked in four lengths and five diameters. Other cut lengths are available upon request.



Application Guide and Ordering Information for 3M HDCW Wraparound Heat Shrink Cable Repair Sleeves

Part Number	UPC (051138-)	Length in. (mm)	600/1000V Conductor Size (AWG or MCM)	Jacket Repair Use Range Max./Min. in. (mm)	Sleeve Dimensions	
					Expanded Diameter in. (mm)	Reserved Diameter in. (mm)
HDCW 35/10-250	48416	9.8" (250 mm)	#8-2/0	1.38-0.39" (35-10 mm)	1.97" (50 mm)	0.32" (8 mm)
HDCW 35/10-1200	48436	47.2" (1200 mm)	#8-2/0	1.38-0.39" (35-10 mm)	1.97" (50 mm)	0.32" (8 mm)
HDCW 55/15-500	48421	19.7" (500 mm)	3/0-400	2.17-0.59" (55-15 mm)	2.95" (75 mm)	0.51" (13 mm)
HDCW 55/15-1200	48437	47.2" (1200 mm)	3/0-400	2.17-0.59" (55-15 mm)	2.95" (75 mm)	0.51" (13 mm)
HDCW 80/25-750	48426	29.5" (750 mm)	500-1000	3.15-0.98" (80-25 mm)	3.94" (100 mm)	0.91" (23 mm)
HDCW 80/25-1200	48438	47.2" (1200 mm)	500-1000	3.15-0.98" (80-25 mm)	3.94" (100 mm)	0.91" (23 mm)
HDCW 110/30-1000	48431	39.4" (1000 mm)	1000-2000	4.33-1.18" (110-30 mm)	5.20" (132 mm)	0.98" (25 mm)
HDCW 110/30-1200	48439	47.2" (1200 mm)	1000-2000	4.33-1.18" (110-30 mm)	5.20" (132 mm)	0.98" (25 mm)
HDCW 140/40-1000	48435	39.4" (1000 mm)	N/A	5.39-1.38" (137-35 mm)	5.71" (145 mm)	1.26" (32 mm)
HDCW 140/40-1200	48440	47.2" (1200 mm)	N/A	5.39-1.38" (137-35 mm)	5.71" (145 mm)	1.26" (32 mm)

3M™ Safety Sock Grounding Kits, Shielded and Jacketed URD Cable

For use on tape or wire shield and jacketed concentric neutral (JCN) cables. Provides continuity of the cable shield system and a path to ground in the event of a dig-in.

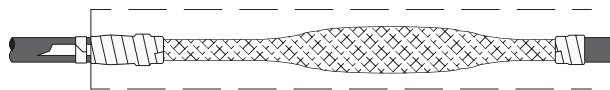

Ordering Notes:

- Each kit contains shielding for one splice
- Use the shield diameter range as final ordering criteria
- A re-jacketing sleeve, such as the 3M Ground Kits SJ Series, must be applied over shielding
- Kit contents: copper screen sleeve, mastic seal strips, constant-force springs, instructions

Specifications and Ordering Information for 3M™ Safety Sock Series Grounding Kits

Product Number	UPC (051141-)	Cable Size	Shield Diameter Range	Case Qty.
SS-A	40745	—	0.47-0.78" (12-20 mm)	—
SS-1	15555	#2-3/0	0.78-1.47" (20-37 mm)	1
SS-2	15561	#4/0-500 kcmil	1.0-2.20" (25-56 mm)	1
SS-3	15557	500-1250 Kcmil	1.5-2.93" (38-74 mm)	1
SS-4	40455	—	1.77-4.21" (45-107 mm)	—

These kits are available in Canada only.

3M™ Scotchcast™ Jacket Repair Kits M Series

Scotchcast Jacket Repair Kits M Series contain a reusable wrap-around mold and accessory materials needed to make 10 permanent, flexible and moisture-resistant jacket repairs or splices of portable cable. The kit contains a wrap around mold that permits jacket repair without cutting through the cable. When used with 3M Scotchcast Resin 2130, M series kits provide durable, flexible jacket repair. Scotchcast kits can be used with portable power cable or standard cable.

Note: Scotchcast flame-retardant compound 2130 needed to jacket the repair or splice is not included and must be ordered separately. U.S. Mine Safety and Health Administration acceptance No. P-142-5 MSHA.

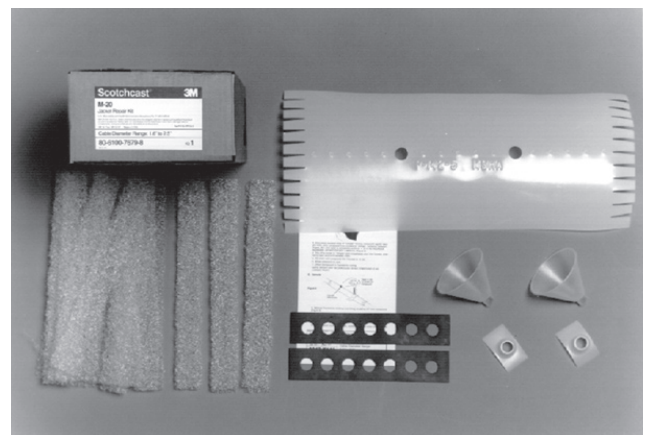

3M™ Scotchcast™ Jacket Repair Kits M Series

Specifications and Ordering Information for 3M Scotchcast Jacket Repair Kits M Series

Product Number	M-20	M-30	M-40
Cable Diameter Range	1.60-2.5" (41-64 mm)	1.85-4.0" (47-102 mm)	1.85-6.0" (47-152 mm)
Maximum Repair Length	13-15" (33-38 cm)	20" (51 cm)	32" (81 cm)
Ordering Information			
UPC (054007-)	31392	31393	31394
Case Qty.	1 kit	1 kit	1 kit

It's all about quality control



Sealing and Grounding

3M™ Cold Shrink Cable Accessory Sealing Kits 8450 Series are designed to seal the end of JCN cable. Use these kits when installing elbows or other cable accessories that do not include a jacket seal. 3M also offers three types of sheath sealing or breakout kits; poured resin, cold shrink and heat shrink, several heat shrink cable sealing end caps and a variety of grounding hardware.

3M™ Cold Shrink Cable Accessory Sealing Kits 8450 Series

The 3M Cold Shrink Cable Accessory Sealing Kits 8450 Series are designed to seal the jacket end of power cables where elbows or other cable accessories are installed. Both the sealing tube and mastic are compatible with commonly used power cable jacketing and semiconductive materials.



Note: Elbow not included.

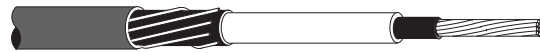
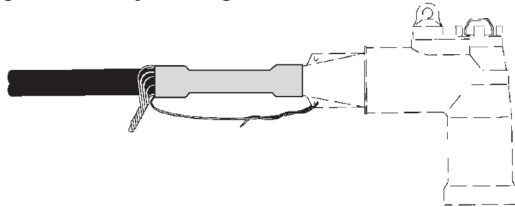

Jacketed Concentric Neutral Cable (JCN)

Specifications and Ordering Information for 3M Cold Shrink Cable Accessory Sealing Kits 8450 Series

Product Number	8452	8452L	8453	8454
CABLE TYPE	Jacketed Concentric Neutral Cable (JCN) See above for cable type illustration.			
CABLE SIZE/VOLT CLASS:				
Cable Size for 15 kV Class	2-4/0 AWG (35-100 mm ²)	2-4/0 AWG (35-100 mm ²)	2/0 AWG-1000 kcmil (70-500 mm ²)	750-1500 kcmil (380-725 mm ²)
Cable Size for 25 kV Class	2-2/0 AWG (35-50 mm ²)	2-2/0 AWG (35-50 mm ²)	1/0 AWG-750 kcmil (60-380 mm ²)	600-1250 kcmil (325-625 mm ²)
Cable Size for 35 kV Class	1/0 AWG (60 mm ²)	1/0 AWG (60 mm ²)	1/0 AWG-500 kcmil (60-250 mm ²)	350-1000 kcmil (180-500 mm ²)
Minimum Seal Diameter	0.95" (24 mm)	0.95" (24 mm)	1.28" (33 mm)	1.60" (41 mm)
Maximum Installed Diameter	1.94" (49 mm)	1.94" (49 mm)	2.67" (68 mm)	3.50" (89 mm)
KIT COMPONENTS:				
Cold Shrink Sealing Tube	1	1 (1/2" longer)	1	1
Mastic Sealing Strips 6" (152,4 mm)	3 strips	3 strips	4 strips	6 strips
Instructions	1	1	1	1
Ordering Information				
UPC (054007-)	08336	44312	09676	49938
Inner Unit Pack	1/bag	—	1/bag	—
Case Qty.	10 kits	10 kits	10 kits	10 kits

3M™ Cold Shrink Shield Adapter Kits 8459/8460 Series

3M Cold Shrink Shield Adapter Kits are designed for grounding and sealing tape, wire and UniShield shielded power cables when using cable accessories such as elbows, modular splices and terminations.

These cold shrink kits require no heat, special tools or special skills to install. The cold shrink kits come complete with all necessary components (except the cable accessory) and are installed in a few simple steps. We've even attached a "bleeder wire" to the ground strap eliminating the need for additional wire and connectors.

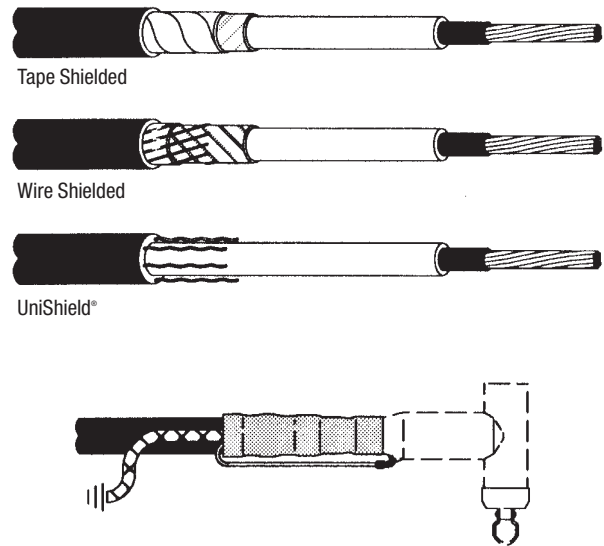

Specifications and Ordering Information for 3M Cold Shrink Shield Adapter Kits 8459/8460 Series

Product Number	8459	8460	8461	8462
CABLE TYPE	Tape Shielded, Wire Shielded, Unishield* See above for cable type illustration.			
JACKET O.D. RANGE				
Inches (mm)	0.59-1.05 (15,0-26,6)	0.83-1.64 (21,1-41,6)	1.27-2.17 (32,3-55,1)	1.70-2.60 (43,2-66,0)
CABLE SIZE/VOLT CLASS:				
Cable Size for 5/8 kV Class	8-1 kcmil (10-38 mm ²)	1/0 AWG-350 kcmil (50-200 mm ²)	500-1000 kcmil (240-500 mm ²)	—
Cable Size for 15 kV Class	—	2-250 kcmil (35-150 mm ²)	350-1000 kcmil (185-500 mm ²)	1250-1750 kcmil (600-850 mm ²)
Cable Size for 25 kV Class	—	2-250 kcmil (35-150 mm ²)	350-750 kcmil (185-500 mm ²)	1000-1500 kcmil (600-725 mm ²)
Cable Size for 35 kV Class	—	2-1/0 kcmil (35-60 mm ²)	2/0 AWG-350 kcmil (70-200 mm ²)	500-1000 kcmil (240-500 mm ²)
KIT COMPONENTS:				
Cold Shrink Sealing Tube	1	1	1	1
Mastic Sealing Strips 6" (152,4 mm)	3 strips	3 strips	3 strips	3 strips
Constant Force Spring	1	1	1	1
Preformed Ground Braid/ Bleeder Wire	1	1	1	1
Scotch® 13 Semi-Conductive Tape	1 strip	1 strip	1 strip	1 strip
Instructions	1	1	1	1
Ordering Information				
UPC (054007-)	53236*	41458	41459	53131*
Inner Unit Pack	1/bag	1/bag	1/bag	1/bag
Case Qty.	3 kits	3 kits	3 kits	3 kits
* UPC 051128-				

3/C Cable Breakout Boots and 3/C Phase Rejacketing System

3M™ Cold Shrink Silicone Rubber 3/C Cable Breakout Boots 8560 Series and 3M Silicone Rubber RJS Series 3/C Phase Rejacketing Systems are designed to be used in conjunction with 3M terminations, to seal the breakout area and rejacket the phases on three conductor cable without grounds.

3M™ Cold Shrink Silicone Rubber 3/C Cable Breakout Boots 8560 Series

3M Silicone Cold Shrink Cable Breakout Boots 8561 through 8565 are a series of open-ended molded rubber sealing assemblies that are factory expanded and mounted on removable inner-supporting plastic cores. They are supplied for field installation in a pre-stretched condition.

The supporting cores are removed after the seal has been positioned for installation around the breakout area of a three conductor cable. Core removal allows the silicone rubber boot to shrink down to a predetermined diameter, creating an environmental enclosure for individual cable phase legs and the overall cable jacket.

3M Breakout Boots 8560 Series are designed to protect the phase leg breakout of 3/C medium voltage power cable from exposure to moisture, contamination, corrosion, ozone, ultra-violet radiation, physical contact and other hazards associated with 3/C termination operating environments. 3M Breakout Boots 8560 Series can be used in conjunction with 3M Silicone Rubber Cold Shrink Rejacketing Sleeves for 3/C shielded power cable terminating applications.



3M™ QT-III Silicone Rubber

Features and Benefits:

- Versatile; installs quickly and accommodates a wide range of cable sizes
- Simple hand application; no need for special installation tools
- No torches or heat required
- No specific user skills or craftsmanship required
- Excellent resistance to ozone and ultra-violet radiation
- High dry and wet insulation resistance
- Highly flexible; accommodates all power cable supplier bend radius recommendations
- Seals tight; retains resiliency and pressure even after prolonged years of aging and exposure
- Compatible with all 3M Cold Shrink Termination Products and RJS Series Phase Rejacketing Sleeves

3M™ 3/C Phase Rejacketing System

3M RJS Series Rejacketing Sleeves are designed so that 3M Cold Shrink QT-III and Q-TIII Silicone Rubber Terminations can be used on 3/C (three conductor) medium voltage shielded power cables of tape shield, wire shield, armored and non-armored configurations. RJS Rejacketing Assemblies are a series of silicone rubber insulators incorporating an inner-expandable polyester braid designed to reduce sliding friction and deliver the insulator onto the cable. Rejacketing sleeves are designed to protect the phase legs (core) of 3/C shielded power cable from exposure to moisture, corrosion, ozone, ultra-violet radiation, physical contact and other hazards associated with termination operating environments. Rejacketing sleeves are designed to be used in conjunction with 3M Cold Shrink Breakout Boots and Silicone Rubber Terminations.

Features and Benefits:

- Versatile; installs quickly and accommodates a wide range of cable sizes
- Simple hand application; no need for special installation tools
- No torches or heat required
- No specific user skills or craftsmanship required
- Excellent resistance to ozone and ultra-violet radiation
- High dry and wet insulation resistance
- Excellent shelf life
- Easy-to-adjust sleeve length; adapts to variable equipment connection and mounting requirements
- Compatible with 3M Cold Shrink PST Breakout Boots and Termination Products

3M™ Cold Shrink Silicone Rubber 3/C Cable Breakout Boots 8560 Series

Product Number	UPC (054007-)	Cable Phase Shield Diameter Range mm (in.)	Cable Outer Jacket Diameter Range mm (in.)	Inner Unit Pack	Case Qty.
8561	43143	12.2-18.3 mm (0.48-0.72")	29.7-49.3 mm (1.17-1.94")	—	1/box
8562	43144	15.5-24.2 mm (0.61-0.95")	37.1-67.8 mm (1.46-2.67")	—	1/box
8563	43145	20.8-30.0 mm (0.82-1.18")	48.8-78.7 mm (1.92-3.10")	—	1/box
8564	43146	26.0-41.1 mm (1.02-1.63")	64.0-109.8 mm (2.52-4.32")	—	1/box
8565	43147	27.7-49.3 mm (1.09-1.94")	66.1-119.4 mm (2.60-4.70")	—	1/box
8566	57174*	29.8-47.9 mm (1.17-1.89")	80.7-140.2 mm (3.18-5.52")	—	1/box

* UPC prefix 051128-

3M™ 3/C Phase Rejacketing Sleeve Selection Guide—Based on Diameter Range and Cable Conductor Size

Product Number	UPC (054007-)	Size (feet)	Metallic Shield Diameter Range mm (in.)	3.3 kV (mm) IEC	3.3 kV (mm) JIS	5.0 kV (AWG) AEIC	6.6 kV (mm) IEC	6.6 kV (mm) JIS	8.0 kV (AWG) (AEIC)	Inner Unit Pack	Case Qty.
RJS-1-4FT	43098	4'	10.9-15.2 mm (0.43-0.60")	16-35	8-22	8-2	16-25	8-10	6-4	—	10
RJS-1-1FT	43099	10'	10.9-15.2 mm (0.43-0.60")	16-35	8-22	8-2	16-25	8-10	6-4	—	1
RJS-2-4FT	43100	4'	15.2-20.3 mm (0.60-0.80")	50-95	38-60	1-3/0	35-70	14-38	2-2/0	—	10
RJS-2-10FT	43101	10'	15.2-20.3 mm (0.60-0.80")	50-95	38-60	1-3/0	35-70	14-38	2-2/0	—	1
RJS-3-4FT	43102	4'	20.3-26.0 mm (0.80-1.02")	120-185	100-150	4/0-400	95-150	60-100	3/0-350	—	10
RJS-3-10FT	43103	10'	20.3-26.0 mm (0.80-1.02")	120-185	100-150	4/0-400	95-150	60-100	3/0-350	—	1
RJS-4-4FT	43104	4'	25.9-32.4 mm (1.02-1.28")	240-300	200-250	500-750	185-300	150-250	400-600	—	10
RJS-4-10-FT	43105	10'	25.9-32.4 mm (1.02-1.28")	240-300	200-250	500-750	185-300	150-250	400-600	—	1
RJS-5-4FT	43106	4'	32.5-41.1 mm (1.28-1.62")	—	300-325	800-1000	—	300-325	750-1000	—	10
RJS-5-10FT	43107	10'	32.5-41.1 mm (1.28-1.62")	—	300-325	800-1000	—	300-325	750-1000	—	1

3M™ 3/C Phase Rejacketing Sleeve Selection Guide—Based on Diameter Range and Cable Conductor Size

Product Number	UPC (054007-)	Size (feet)	Metallic Shield Diameter Range mm (in.)	10 kV (mm) IEC	15 kV (AWG) AEIC	20 kV (mm) IEC	25 kV (AWG) AEIC	30 kV (mm) IEC	35 kV (AWG) AEIC	Inner Unit Pack	Case Qty.
RJS-1-4FT	43098	4'	10.9-15.2 mm (0.43-0.60")	—	—	—	—	—	—	—	10
RJS-1-1FT	43099	10'	10.9-15.2 mm (0.43-0.60")	—	—	—	—	—	—	—	1
RJS-2-4FT	43100	4'	15.2-20.3 mm (0.60-0.80")	10-50	2-1	—	—	—	—	—	10
RJS-2-10FT	43101	10'	15.2-20.3 mm (0.60-0.80")	10-50	2-1	—	—	—	—	—	1
RJS-3-4FT	43102	4'	20.3-26.0 mm (0.80-1.02")	70-150	1/0-4/0	25-70	2-1/0	—	—	—	10
RJS-3-10FT	43103	10'	20.3-26.0 mm (0.80-1.02")	70-150	1/0-4/0	25-70	2-1/0	—	—	—	1
RJS-4-4FT	43104	4'	25.9-32.4 mm (1.02-1.28")	185-300	250-450	95-185	2/0-250	35-70	1/0-3/0	—	10
RJS-4-10FT	43105	10'	25.9-32.4 mm (1.02-1.28")	185-300	250-450	95-185	2/0-250	35-70	1/0-3/0	—	1
RJS-5-4FT	43106	4'	32.5-41.1 mm (1.28-1.62")	—	500-750	240-300	300-500	95-240	4/0-500	—	10
RJS-5-10FT	43107	10'	32.5-41.1 mm (1.28-1.62")	—	500-750	240-300	300-500	95-240	4/0-500	—	1

3M™ 3/C Phase Rejacketing Kits RJK Kits for Converting 3/C Cable to Three 1/C Cables

Indoor/ Outdoor Kits	Indoor Kits	Cable Metallic Shield Diameter Range	5 kV	8 kV	15 kV	25/28 kV
RJK-1	RJS-2/3	0.60-0.80	1-3/0	2-2/0	1-2/0	
RJK-2	RJS-3/3	0.80-1.02	4/0-400	3/0-30	1/0-4/0	2-1/0
RJK-3	RJS-4/3	1.02-1.28	500-750	400-600	250-450	2/0-250
RJK-4	RJS-5/3	1.28-1.62	800-1000	750-1000	500-750	300-500

Kit Contents

- 3M Cold Shrink breakout boot, 3M Cold Slip rejacketing sleeves (3 four-foot lengths), provision to externally ground at breakout boot
- 3M Cold Slip rejacketing sleeves (3 four-foot lengths)

Cold Slip

3M Cold slip re-jacketing sleeves incorporate an inner-expandable polyester braid designed to reduce sliding friction and deliver the sleeve quickly onto the cable.

Cold Shrink

3M Cold Shrink splicing products are designed using 3M's unique cold shrink delivery system. Products are supplied pre-stretched on a removable core for efficiency and ease of installation. All splices are pre-tested in the factory.

3M™ Sheath Seal Kits for Multiconductor Cable

3M offers three types of sheath sealing or breakout kits: poured resin, cold shrink and heat shrink. 3M offers two types of heat shrink cable sealing, caps and a variety of grounding hardware.

3M™ Sheath Seal Kits 5831 and 5832

3M Sheath Seal Kits 5831 and 5832 are designed to seal the sheath area for multiconductor cables with or without ground wires. They will handle copper or aluminum cables from #2 AWG through 500 kcmil (35-250 mm²). For kit contents and sizing, see chart below. Each kit makes one seal.

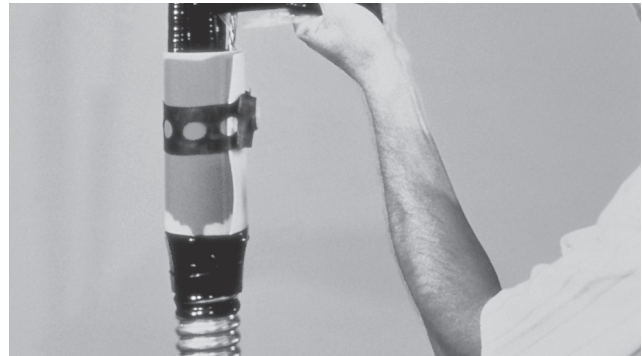

3M™ Sheath Seal Kits 5831 and 5832

3M™ Cold Shrink Sheath Seal Kits 5841 and 5842

3M Cold Shrink Sheath Seal Kits 5841 and 5842 are designed to seal the sheath area for three conductor cables without ground wires. They will handle copper or aluminum cable from #2 AWG through 500 kcmil (35-250 mm²). No heat is required when using these kits. For kit contents and sizing, see chart below. Each kit makes one seal.

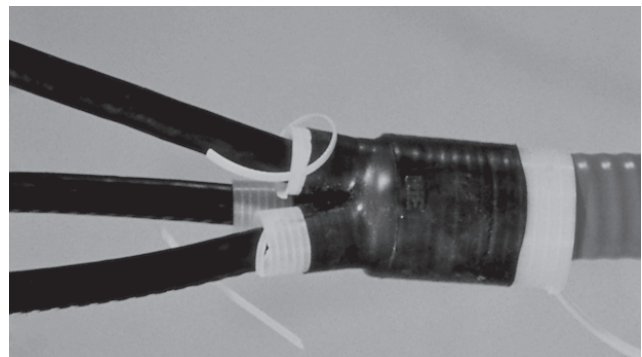

3M™ Cold Shrink Sheath Seal Kits 5841 and 5842

Specifications for 3M Sheath Seal Kits

Specifications	5831	5832	5841	5842
Conductor Size	2-3/0 AWG (35-80 mm ²)	4/0 AWG-500 kcmil (120-250 mm ²)	2-4/0 AWG (35-100 mm ²)	4/0 AWG-500 kcmil (120-250 mm ²)
Maximum Jacket or Armor O.D. Range	2.6" (66 mm)	3.75" (95,2 mm)	—	—
Conductor Insulation O.D. Range	N/A	N/A	0.30-1.18" (8-30 mm)	0.77-1.38" (20-35 mm)
Cable Jacket Range	—	—	1.20-1.90" (30-48 mm)	1.80-3.10" (46-79 mm)
KIT COMPONENTS:				
Molded Sheath Seal Body	—	—	1	1
Wraparound Mold Body	1	1	—	—
3M™ ScotchCast™ 2130	1	1	—	—
Abrasive Cloth	1	1	—	—
Scotch® Vinyl Electrical Tape Super 33+	1	1	—	—
Scotch® Linerless Rubber Splice Tape 130C	1	1	—	—
3M Scotchfil™ Electrical Insulation Putty	1	1	—	—
Instructions	1	1	1	1

Note: Each kit makes one seal.

Ordering Information for 3M Sheath Seal Kits

Ordering Information	5831	5832	5841	5842
UPC (054007-)	12280	12281	12291	12292
Case Qty.	1 kit	1 kit	1 kit	1 kit

The final determining factor for the 5831 and 5832 is the conductor insulation O.D. and the cable jacket O.D.

The final determining factor for the 5841 and 5842 is the maximum jacket or armor diameter.

Note: Each kit makes one seal.

3M™ Heat Shrinkable Cable Breakout Boots

3M Heat Shrinkable HDBB Cable Breakout Boots are designed for dependable insulating and sealing of cable breakouts in multiconductor armored or sheathed cables and conduit ends. 3M HDBB boots are made from flame retardant, cross-linked polyolefin and meet the material requirements of MIL-I-81765-1. The boots are designed to provide excellent electrical and mechanical protection and are supplied with an internal coating of adhesive for reliable environmental sealing.



3M™ Heat Shrinkable Cable Breakout Boots

Specifications and Ordering Information for 3M™ Heat Shrinkable Cable Breakout Boots



Product Number	Cross Section	UPC (054007-)	Cable Entry End (Max. to Min.)	Conductor Legs (Max. to Min.)	Case Qty.
HDBB-205-1-250		58793	0.80-0.37" (20,32-9,40 mm)	0.33-0.11" (8,38-2,79 mm)	1 each
HDBB-210-1-250		35992*	1.20-0.60" (30,38-15,24 mm)	0.50-0.17" (12,70-4,32 mm)	1 each
HDBB-220-1-250		46654**	1.90-0.90" (48,26-22,86 mm)	0.75-0.30" (19,05-7,62 mm)	1 each
HDBB-230-1-250		35993*	3.00-1.50" (76,20-38,10 mm)	1.45-0.50" (38,10-12,70 mm)	1 each
HDBB-310-1-250		35994*	0.90-0.36" (2,86-9,14 mm)	0.33-0.12" (8,38-3,05 mm)	1 each
HDBB-320-1-250		35995*	1.20-0.50" (30,38-12,70 mm)	0.50-0.16" (12,70-4,06 mm)	1 each
HDBB-321-1-250		35996*	1.50-0.69" (38,10-17,53 mm)	0.65-0.18" (16,51-4,57 mm)	1 each
HDBB-325-1-250		35997*	1.70-0.90" (43,18-22,86 mm)	0.82-0.30" (20,83-7,62 mm)	1 each
HDBB-335-1-250		03409*	2.40-1.40" (60,96-35,56 mm)	1.25-0.50" (31,75-12,70 mm)	1 each
HDBB-340-1-250		35998*	3.20-2.00" (81,28-50,80 mm)	1.45-0.75" (38,10-19,05 mm)	1 each
HDBB-345-1-250		58794	4.90-2.32" (124,46-5,93 mm)	2.00-1.00" (50,80-25,40 mm)	1 each

*UPC prefix 051135-

**UPC prefix 051138-

Note: 3M Breakout Boots are flame retardant and supplied with a factory-applied sealant. Unlined boots are available on special order. All boots are black in color. Standard package is one and multiples of one.

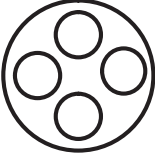
Specifications and Ordering Information for 3M™ Heat Shrinkable Cable Breakout Boots

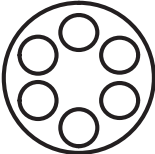
Product Number	Cross Section	UPC (054007-)	Cable Entry End (Max. to Min.)	Conductor Legs (Max. to Min.)	Case Qty.
HDBB-405-1-250		58795	0.90-0.43" (22,86-10,92 mm)	0.28-0.11" (7,11-2,79 mm)	1 each
HDBB-410-1-250		35999*	1.25-0.80" (31,75-20,32 mm)	0.50-0.19" (1,70-4,83 mm)	1 each
HDBB-415-1-250		58855	1.75-0.98" (43,18-24,89 mm)	0.79-0.28" (20,07-7,11 mm)	1 each
HDBB-420-1-250		36000*	2.35-1.00" (59,69-2,4 mm)	1.00-0.35" (25,40-8,89 mm)	1 each
HDBB-425-1-250		58797	2.65-1.40" (67,31-35,56 mm)	1.20-0.53" (30,48-13,46 mm)	1 each
HDBB-430-1-250		58798	5.25-3.00" (133,35-76,20 mm)	1.35-0.55" (34,29-13,97 mm)	1 each
HDBB-505-1-250		46648**	2.36-0.96" (59,94-24,38 mm)	1.18-0.29" (70,73-7,36 mm)	1 each
HDBB-605-1-250		36001*	2.39-1.45" (60,71-38,10 mm)	0.80-0.35" (20,32-8,89 mm)	1 each
					

*UPC prefix 051135-

**UPC prefix 051138-

Note: 3M Breakout Boots are flame retardant and supplied with a factory-applied sealant. Unlined boots are available on special order. All boots are black in color. Standard package is one and multiples of one.

PRODUCT REFERRAL GENERATOR

- Insulating pg. 418
 - Heat Shrinkable Tubing
- Sealing pg. 401
 - Cold Shrink End Caps

3M™ Cold Shrink End Caps EC-Series

The 3M Cold Shrink End Caps EC-Series are designed to environmentally seal and mechanically protect exposed cable ends using no tools, mastics or tapes. Regardless of the cable type or manufacturer, it takes only four different end-caps to fit cable size ranges from 1.46" to 3.32" (11,6-84,3 mm), reducing the need for additional inventory to cover all cable sizes. The 3M Cold Shrink End Caps EC-Series protects cables, pipes and other cylindrical objects from exposure to moisture, contamination, corrosion, ozone, ultra-violet radiation, physical contact and other environmental hazards.

3M™ Heavy-Duty End Caps SKE

3M Heat Shrinkable End Caps are typically used to seal cable ends and are designed to provide moisture, mechanical and environmental protection. 3M SKE end caps are for heavy-duty applications.

3M SKE end caps are manufactured from semi-rigid flame retardant, cross-linked polyolefin. They are supplied with

a factory applied adhesive lining for reliable environmental sealing. Six different sizes accommodate a broad range of cable diameters.

Standard Color: Black.

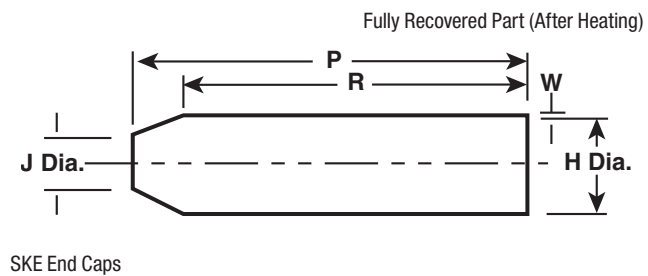
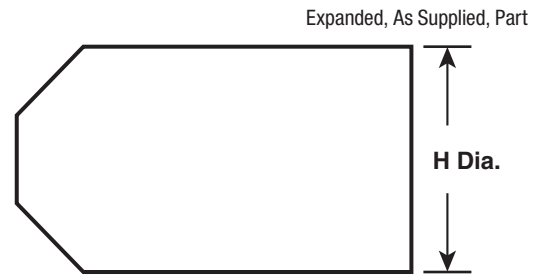

Specifications and Ordering Information for 3M Cold Shrink End Caps EC-Series

Product Number	UPC (051138-)	Use Range Inches (mm)	Inner Unit Pack
EC-1	52440	0.46-0.82" (11,6-20,9 mm)	10/box
EC-2	52441	0.63-1.18" (15,9-30,1 mm)	10/box
EC-3	52442	1.02-1.94" (26,0-49,2 mm)	10/box
EC-4	52443	1.79-3.32" (45,5-84,3 mm)	10/box

Specifications and Ordering Information for 3M Heavy-Duty End Caps SKE

Product Number	UPC (051138-)	H Dia. Min. X	Max. R	J Dia. Max. R	P ±10% R	R ±10% R	W ±20% R	For Cable Diameter	Case Qty.
SKE 4/10	48153	0.39 (10,0)	0.16 (4,0)	0.12 (3,0)	1.32 (33,5)	1.18 (30,0)	0.08 (2,0)	0.16-0.31 (4-8)	1000 each
SKE 8/20	48154	0.79 (20,0)	0.30 (7,5)	0.26 (6,5)	2.18 (55,3)	1.97 (50,0)	0.09 (2,3)	0.31-0.43 (8-11)	250 each
SKE 15/40	48155	1.57 (40,0)	0.59 (15,0)	0.41 (10,5)	3.54 (90,0)	3.15 (80,0)	0.12 (3,0)	0.59-1.26 (15-32)	60 each
SKE 25/63	48156	2.48 (63,0)	0.98 (25,0)	0.63 (16,0)	5.63 (143,3)	5.12 (130,0)	0.13 (3,3)	1.00-1.97 (25-50)	60 each
SKE 30/76	48157	2.99 (76,0)	1.18 (30,0)	0.67 (17,0)	6.22 (158,0)	5.91 (150,0)	0,16 (4,0)	1.18-2.36 (30-60)	40 each
SKE 45/100	48158	3.94 (100,0)	1.77 (45,0)	1.02 (26,0)	6.40 (162,5)	5.50 (140,0)	0.16 (4,0)	1.77-3.15 (45-80)	30 each

NOTES:

- All dimensions in both inches and metric. All angles in degrees.
- Dimensions in table: X= Expanded (Minimum); R= Recovered (Maximum)
- Color: Black

3M™ Hi-Amp Splice Grounding Accessory Kit SG-2 and SG-3 for 15 kV, 25 kV and 35 kV

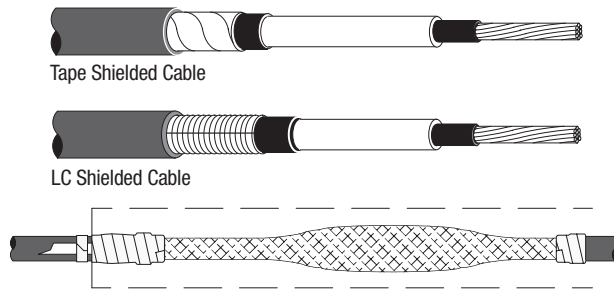

3M Hi-Amp Splice Grounding Accessory Kit SG-2 and SG-3 are designed to accommodate the shielding and grounding of inline splices made on LC, heavy-duty tape and conventional tape shielded power cables. The SG-2 and SG-3 designs provide a fault current capacity of 15,000 Amps for 15 cycles on 15, 25 and 35 kV class cables.

The 3M kits SG-2 and SG-3 were designed to accommodate all 3M Quick Splice bodies as well as most other rubber-molded inline splices currently used in the electrical power distribution industry.

The 3M copper screen sleeves SG-2 and SG-3 are applied over molded rubber splices on cables with shield diameters ranging from 1.25" (32,0 mm) to 2.25" (57,2 mm). In most cases this will include conductor sizes between 350 kcmil and 1000 kcmil and voltage classes of 15 kV through 35 kV. The 3M copper screen sleeves SG-2 and SG-3 and the preformed ground connection braid have a capacity greater than that of #4 AWG copper wire and are fault current rated at 15,000 amps for 15 cycles. The 3M Kit SG-3 has a larger CMA (greater than 2 AWG) copper screen sleeve and two constant force springs per end. This provides additional neutral current capacity.

Following SG-2 and SG-3 component installation, 3M Cold Shrink SJ-1A, SJ-2A, SJ-3A, heat shrink HSJ series or Scotch® Rubber Mastic and Vinyl Tape systems are the recommended choices for sealing and re-jacketing the installed, shielded splice. Each kit provides shielding and grounding for one splice.

Refer to the ordering table on page 401 for cable and accommodation. Final determining factor, for cables not specified, is a shield diameter range from 1.25" (32,0 mm) minimum through 2.25" (57,2 mm) maximum.

3M™ Hi-Amp Accessory Grounding Kit 8473 for 15 kV, 25 kV and 35 kV

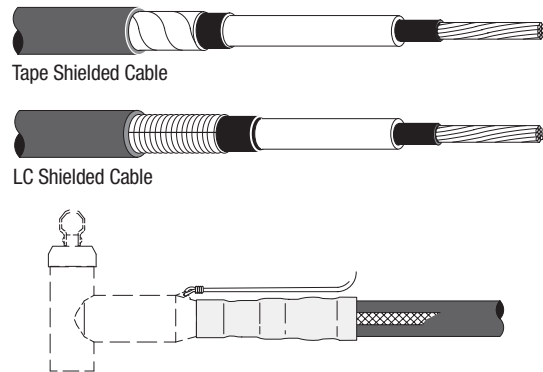

3M Hi-Amp Accessory Grounding Kit 8473 is designed to accommodate the grounding of accessories installed on LC, heavy-duty tape and conventional tape-shielded power cables. The 3M Grounding Kit 8473 design provides a fault current capacity of 15,000 Amps for 15 cycles on 15 kV, 25 kV and 35 kV class cables.

Product application range for the 3M kit 8473 includes cable sizes from 350 kcmil through 1000 kcmil in 15 kV through 35 kV voltage classes as indicated in the table on page 401.

The kit 8473 was designed to be used with 600-Amp elbows and other accessories where cable jacket-to-accessory sealing and high-ampacity grounding is desired.

The 3M Grounding Kit 8473 preformed ground braid has a fault current capacity of 15,000 Amps for 15 cycles with an equivalent cross-sectional area greater than #4 AWG copper wire. Each kit provides grounding and sealing for one accessory.

Refer to the ordering table on page 401 for cable accommodation. Final determining factor, for cables not specified, is a shield diameter range from 1.25" (32,0 mm) minimum through 2.25" (57,2 mm) maximum.

3M™ Hi-Amp Grounding Accessory Kit GSHA-8 QT-II for 15 kV, 25 kV and 35 kV

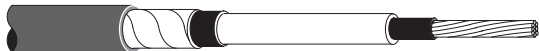

Tape Shielded Cable



LC Shielded Cable

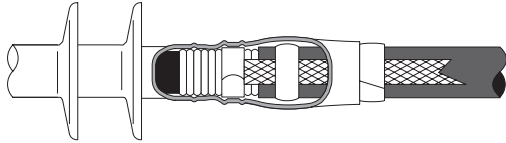

3M Hi-Amp Grounding Accessory Kit GSHA-8 QT II is designed to accommodate the grounding of terminations made on LC, heavy-duty tape and conventional tape-shielded power cables. The 3M Kit GSHA-8 QT II design provides a fault current capacity of 15,000 Amps for 15 cycles on 15 kV, 25 kV and 35 kV class cables.

The 3M Kit GSHA-8 is designed to be used in conjunction with 3M QT-II terminations in applications where high-ampacity grounding is desired.

The 3M product GSHA-8 will accommodate cable sizes ranging from 350 kcmil through 1000 kcmil and voltage

classes of 15 kV through 35 kV. The preformed ground braid contained in the 3M Kit GSHA-8 has a fault current capacity of 15,000 Amps for 15 cycles. Each kit provides shielding and grounding for one termination.

Refer to the ordering table on page 401 for cable information. Final determining factor, for cables not specified, is a shield diameter range from 1.25" (32,0 mm).

3M™ Cable Grounding Kits 2252 and 2253

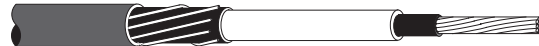

Jacketed Concentric Neutral Cable (JCN)

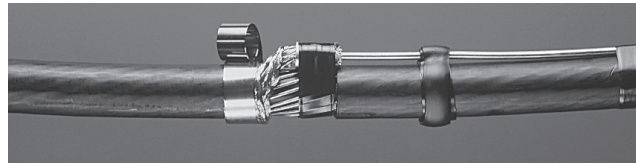

The 3M Cable Grounding Kits 2252 and 2253 provide a simple, reliable and secure method for grounding and resealing of the jacket of direct buried distribution cables. These kits are designed for use with jacketed concentric neutral (JCN) power cables ranging from 2 to 4/0 AWG, rated through 35 kV. A common kit application is for grounding a primary neutral at least every 1320 feet (1/4 mile) per Rural Utilities Service (RUS) Bulletin 83-1.

Specifications for 3M™ Sealing and Grounding Products 15 kV, 25 kV and 35 kV

Specifications	SG-2	SG-3	8473	GSHA-8	2252	2253	2254
CABLE TYPE	Tape Shielded Cable, LC Shielded Cable See pg. 399-400 for cable type illustration.				Jacketed Concentric Neutral Cable (JCN) See pg. 400 for cable type illustration.		
	Each kit provides grounding and sealing for 1 splice or termination				Each kit provides 1 cable ground		
Shield O.D. Range	1.25-2.25" (132,0-52,2 mm)	1.25-2.25" (132,0-52,2 mm)	1.25-2.25" (132,0-52,2 mm)	1.25-2.25" (132,0-52,2 mm)	—	—	—
Conductor Range	350-1000 kcmil	350-1000 kcmil	350-1000 kcmil	350-1000 kcmil	2-4/0 AWG	250-500 kcmil	500-1000 kcmil
Circular Mil Area	61,000	72,000	—	—	—	—	—
KIT COMPONENTS:							
PST Cold Shrink Tube	—	—	1	—	—	—	—
Roll of Scotch® 13 Semiconducting Tape	—	—	—	1	—	—	—
Roll of Scotch 2228 Rubber Mastic Tape	—	—	—	—	1	1	1
Roll of Scotch Super 33+ Vinyl Electrical Tape	—	—	—	—	1	1	1
Tin-Plated Copper "C" Connector	—	—	—	—	1	1	1

Specifications for 3M™ Sealing and Grounding Products 15 kV, 25 kV and 35 kV

Specifications	SG-2	SG-3	8473	GSHA-8	2252	2253	2254
10" (25,4 cm) Length of Tin Plated Copper Braid	—	—	—	—	1	1	1
Copper Screen Sleeve	1	1	—	—	—	—	—
Mastic Seal Strip	3	3	1	1	1	1	1
Constant-Force Spring	2	4	1	1	1	1	1
Preformed Ground Braid	1	1	1	1	—	—	—
Instructions	1	1	1	1	1	1	1
Ordering Information							
UPC (054007-)	50041	41511	50043	50042	08335	55648*	56939*
Case Qty.	10 each	10 each	10 each	10 each	10 each	10 each	10 each

* UPC prefix 051128-

3M™ Ground Strap Assembly GS Series

3M Ground Strap Assembly Kit GS Series is designed for grounding tape- and wire-shielded power cables. Check that cable conductor size matches the ground strap assembly shown in the ordering table below.

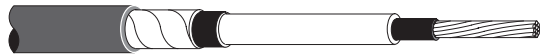

Tape Shielded Cable



Wire Shielded Cable

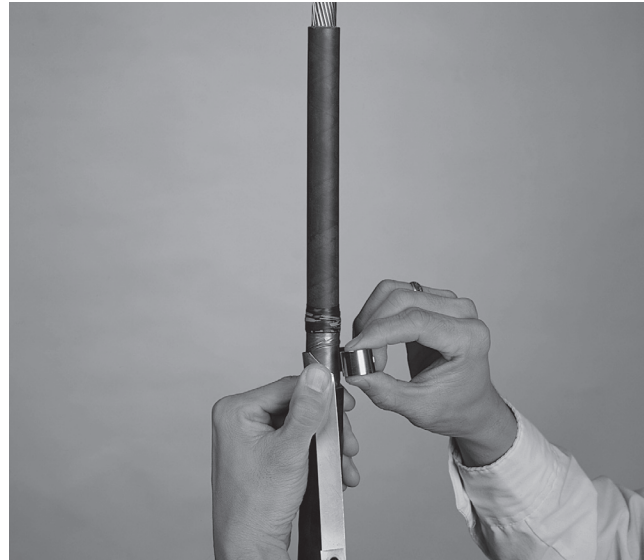

Specifications and Ordering Information for 3M Ground Strap Assembly GS Series

Specifications	GS-1	GS-2	GS-3
CABLE TYPE		Jacketed URD Cable See above for cable type illustration.	
Strap Length x Width	4.75" x 0.31"	7.12" x 0.62"	6.87" x 0.62"
VOLTAGE AND INSULATION THICKNESS		Conductor AWG Size Range (mm ²)	
5 kV-100% 90 mils	8-3/0 (10-80 mm ²)	2/0-750 (70-325 mm ²)	600-2000 (325-1000 mm ²)
5 kV-133% 8 kV -100% 115 mils	8-1/0 (10-50 mm ²)	1/0-750 (60-325 mm ²)	500-2000 (300-1000 mm ²)
8 kV-133% 140 mils	8-1 (10-38 mm ²)	1-600 (50-300 mm ²)	400-1750 (240-850 mm ²)
15 kV- 100% 175 mils	—	2-500 (35-250 mm ²)	350-1750 (180-850 mm ²)
15 kV- 133% 220 mils	—	2-350 (35-180 mm ²)	250-1500 (125-725 mm ²)
25 kV 260 mils	—	2-400 (35-200 mm ²)	3/0-1000 (95-500 mm ²)
35 kV 345 mils	—	1/0-300 (60-150 mm ²)	1/0-750 (60-325 mm ²)
Ordering Information			
UPC (054007-)	33976	33977	33978
Case Qty.	9 each	9 each	9 each

Product Information for 3M™ Constant Force Springs

Product Number	CFS-0.47/0.78	CFS-0.80/1.50	CFS-1.00/2.20	CFS-1.50-3.00	CFS-1.50/3.00W	CFS-1.80/4.00
APPLICATION RANGE						
Min. inches (mm)	0.50" (12,7 mm)	0.80" (20,3 mm)	1.00" (25,4 mm)	1.50" (38,1 mm)	1.50" (38,1 mm)	1.80" (45,7 mm)
Max. inches (mm)	0.75" (19,0 mm)	1.50" (38,1 mm)	2.20" (56,0 mm)	3.00" (76,2 mm)	3.00" (76,2 mm)	4.00" (101,6 mm)
Width inches (mm)	0.500" (12,7 mm)	0.625" (15,9 mm)	0.625" (15,9 mm)	0.625" (15,9 mm)	0.750" (19,0 mm)	0.625" (15,9 mm)
STD. Carton	30	30	30	9	9	9
UPC (054007-)	42372	42374	42375	42376	42378	42379

3M™ Shield Grounding Accessory Kits GSK

3M Shield Grounding Accessory Kits GSK are used to convert CN/JCN termination kits for use on shielded cables minimum through 2.25" (57,2 mm) maximum.



Tape Shielded Cable



LC Shielded Cable

Specifications and Ordering Information for 3M™ QT-II Termination Kit

Product Number	UPC (051128-)	QT-II Term. Kit Number	5 kV (90 mil)	5/8 kV (115 mil)	8 kV (140 mil)	15 kV (175 mil)	15 kV (220 mil)	25/28 kV (260/280 mil)	35 kV (345 mil)
GSK-22	53087	5641	3/0-300	2/0-250	1/0-4/0	2-3/0	2-1/0	—	—
		5651	3/0-300	2/0-250	1/0-4/0	2-3/0	2-1/0	2-1	—
GSK-34	53088	5642	350-750	350-750	250-600	3/0-500	2/0-350	—	—
		5652	350-750	350-750	250-600	3/0-500	2/0-350	1/0-250	—
		5646	350-750	350-750	250-600	3/0-500	2/0-350	1/0-250	2-3/0
GSK-56	53089	5643	750-1500	750-1250	600-1000	500-1000	350-500	—	—
		5644	1000-2000	1000-2000	800-1750	750-1750	600-1500	—	—
		5653	750-1500	750-1250	600-1000	500-1000	350-500	300-500	—
		5654	1000-2000	1000-2000	800-1750	750-1750	600-1500	600-1250	—
		5647	750-1500	750-1250	600-1000	500-1000	350-500	300-500	4/0-400
		5648	1000-2000	1000-2000	800-1750	750-1750	600-1500	600-1250	500-1000

Specifications and Ordering Information for 3M™ QT-III Termination Kit

Product Number	UPC (051128-)	QT-III Term. Kit Number	5 kV (90 mil)	5/8 kV (115 mil)	15 kV (175/220 mil)	25/28 kV (260/280 mil)	35 kV (345 mil)
GSK-22	53087	7642-T-110	4/0-400	3/0-300	2-4/0	—	—
		7642-S-2	4/0-400	3/0-300	2-4/0	—	—
		7652-S-4	4/0-400	3/0-300	2-4/0	2-1/0	—
GSK-34	53088	7653-S-4	300-500	250-500	2/0-300	2-4/0	—
		7654-S-4	500-750	350-700	4/0-500	2/0-250	—
		7644-T-110	500-750	350-700	4/0-500	—	—
		7653-T-150	300-500	250-500	2/0-300	2-4/0	2-2/0
		7663-S-8	300-500	250-500	2/0-300	2-4/0	2-2/0
		7664-S-8	500-750	350-700	4/0-500	2/0-250	2-4/0

Specifications and Ordering Information for 3M™ QT-III Termination Kit



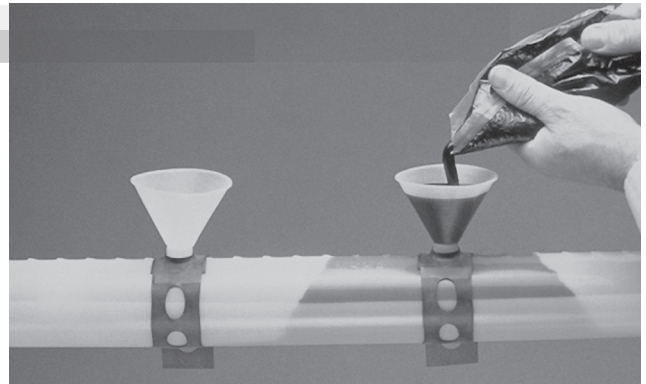

Product Number	UPC (051128-)	QT-III Term. Kit Number	5 kV (90 mil)	5/8 kV (115 mil)	15 kV (175/220 mil)	25/28 kV (260/280 mil)	35 kV (345 mil)
GSK-56	53089	7655-S-4	700-1500	600-1250	500-1000	250-800	—
		7656-S-4	1750-2000	1500-2000	1250-2000	900-1750	—
		7645-T-110	700-1500	600-1250	500-1000	—	—
		7646-T-110	1750-2000	1500-2000	1250-2000	—	—
		7655-T-150	700-1500	600-1250	500-1000	250-800	3/0-600
		7656-T-150	1750-2000	1500-2000	1250-2000	900-1750	700-1500
		7665-S-8	700-1500	600-1250	500-1000	250-800	3/0-600
		7666-S-8	1750-2000	1500-2000	1250-2000	900-1750	700-1500

Insulating and Sealing Compounds

3M™ Scotchcast™ Insulating and Sealing Compounds are compatible with most cable insulations and jackets and accommodate many splices, including odd-shaped connectors. These compounds feature a high degree of mechanical strength and provide moisture resistance for above ground and buried applications.



Specifications for 3M™ Scotchcast Insulating and Sealing Compounds

Product Name	Description	Gel Time @ 73° (23°C)	Energize Time	Used in These 3M Kits	Maximum Operating Temperature	Color
 Scotchcast Electrical Insulating Resin 4	PERMANENT Rigid, hard material Insulating up to 8 kV Jacketing up to 69 kV epoxy	16 mins.	45 mins.*	82-A Series 82-B1 85-14CP 90-B1	194°F (90°C) continuous 266°F (130°C) overload 482°F (250°C) intermittent	Black
 Scotchcast Electrical Insulating and Sealing Compound 2104	PERMANENT Semi-flexible 1000 volts max. Polyurethane	18 mins.	Immediately	72-N 85 Series	194°F (90°C) continuous 266°F (130°C) overload	Dark Green
 Scotchcast 2123 Re-enterable Electrical Insulating Resin	RE-ENTERABLE Flexible polybutadiene	62 mins.	Immediately	78-R Series	194°F (90°C) continuous 266°F (130°C) overload	Amber, Transparent
 Scotchcast Flame Retardant Compound 2130	FLAME RETARDANT Semi-flexible 5000 volts max. Permanent urethane MSHA P-142-5	15 mins.	Immediately	5750, 5760, 5831, 5832, 82-F1, 82-F2, 82-BF1, M-20, -30, -40	194°F (90°C) continuous 266°F (130°C) overload	Black
 Scotchcast Wet-Niche Potting Compound 2135	FLEXIBLE Wet niche putty Urethane	15 mins.	Immediately	—	UL Listed 2L02 220°F (105°C)	Black

*At 73°F (23°C) and cooler temperatures, resin will cure slower. Do not energize until resin has cooled and solidified.

Specifications and Ordering Information for 3M™ Scotchcast™ Resins

Product Number	UPC (054007-)	Size/Type of Package	Inner Unit Pack	Case Qty.
3M SCOTCHCAST ELECTRICAL INSULATING RESIN 4				
4-A	43165	A/3.2 oz. (90 g) 4.8 cu. in. (78,6 cu. cm)	—	10 containers
4-B	43166	B/7.4 oz. (209 g) 11.2 cu. in. (183,5 cu. cm)	—	10 containers
4-C	43167	C/14.7 oz. (418 g) 22.3 cu. in. (365,4 cu. cm)	—	10 containers
4-D	04206	D/22.2 oz. (630 g) 33.6 cu. in. (550,6 cu. cm)	—	10 containers
4-E	04207	E/10.4 oz. (294 g) 15.7 cu. in. (257,2 cu. cm)	—	10 containers
3M SCOTCHCAST ELECTRICAL INSULATING AND SEALING COMPOUND 2104				
2104-A	31189	A/3.46 oz. (98 g) 5.7 cu. in. (93,4 cu. cm)	cont.	10 each
2104-B	31382	B/7.4 oz. (210 g) 12.6 cu. in. (206,4 cu. cm)	cont.	10 containers
2104-C	31383	C/14.82 oz. (420 g) 25.4 cu. in. (416,2 cu. cm)	1/box	10 containers
2104-D	11849	D/23.8 oz. (675 g) 40.8 cu. in. (668,5 cu. cm)	1/box	10 each
3M SCOTCHCAST RE-ENTERABLE ELECTRICAL INSULATING COMPOUND 2123				
2123-C	55120*	C/12.3 oz. (350 g) 23.7 cu. in. (338,3 cu. cm)	1/box	10 each
2123-D	55121*	D/21.2 oz. (600 g) 40.6 cu. in. (665,3 cu. cm)	1/box	10 each
3M SCOTCHCAST FLAME RETARDANT COMPOUND 2130				
2130-B	31401	B/7.6 oz. (216 g) 10.7 cu. in. (175,3 cu. cm)	1/box	10 each
2130-C	31402	C/21.7 oz. (616 g) 30.5 cu. in. (499,8 cu. cm)	1/box	10 each
2130 Part A	50237	A/5 gal. (18,93 L)		1 pail
2130 Part B	50238	B/5 gal. (18,93 L)		1 pail
3M SCOTCHCAST WET-NICHE POTTING 2135				
2135	69798	F/1.83 oz. (52,5 g) 3.3 cu. in. (54,0 cu. cm)	1/box	10 each
3M SCOTCHCAST CABLE REPAIR COMPOUND 2135M				
2135M	50433	F/6.9 oz. (195 g) 12.25 cu. in. (13,12 cu. cm)	—	10 each
*UPC prefix 051128-				

Mounting Brackets

3M™ Mounting Brackets MB and MBS Series

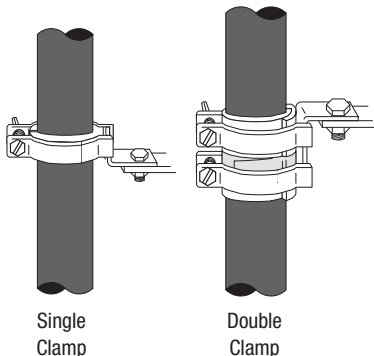

The 3M Mounting Brackets MB and MBS Series have been designed to mount 3M molded rubber terminations. These brackets are attached to the cable just below the termination. This provides a tongue

that can then be attached to an MB-1 mounting bracket or to any other support. The 3M Brackets MB Series are made from galvanized steel. The 3M Brackets MBS Series are made from stainless steel to provide additional corrosion protection in highly contaminated environments.



3M™ Cross-Arm Mounting Bracket MB-1

3M Cross-Arm Mounting Bracket MB-1 is a cross-arm bracket for use in holding terminated cable. The MB-1 is ideal to use when ordering the MB or MBS termination mounting brackets featured on this page.

Specifications and Ordering Information for 3M™ Hardware Accessories

Product Number	UPC (054007-)	Cable O.D. Range	Inner Unit Pack Qty.	Case Qty.
MB-1	11230	—	1/box	10 each
MB-3	14754	0.80-1.25" (20-32 mm)*	1/box	10 each
MB-4	14755	1.10-1.50" (28-38 mm)	1/box	10 each
MB-5**	08200	1.45-1.95" (37-50 mm)	1/box	10 each
MB-6**	08286	1.80-2.40" (46-61 mm)	1/box	10 each
MBS-4**	49685	1.10-1.70" (28-43 mm)	1/box	10 each
MBS-5**	49686	1.45-1.95" (37-50 mm)	1/box	10 each
MBS-6**	49687	1.80-2.40" (46-61 mm)	1/box	10 each

*Caution: Use cable O.D., not insulation O.D. for determining the proper size.

**Has double clamps.

3M™ Cold Shrink Corrosion Protection Kit CPT Series

3M Cold Shrink Corrosion Protection Kit CPT Series are designed to provide a quick and easy method for protecting bulkhead termination connectors from the corrosive influences of wet and salt-fog installation environments.

A CPT series assembly is an open-ended tubular rubber sleeve which is factory expanded and assembled onto a removable core. The core is removed after the assembly has been positioned for installation over a bulkhead terminator connector. Mastic strips are provided for sealing between NPT fitting threads and the enclosure in use (junction box, cabinet, panel board, etc.). CPT insulating sleeves are made of an EPDM rubber that contains no chlorides or sulfers. Ten kits accommodate 1/2" through 4" bulkhead connectors.

To extend the useful life of this product in applications where continuous exposure to high levels of ultra-violet radiation are expected, overwrap with Scotch® Super 33+™ Vinyl Electrical Tape or Scotch Silicone Tape 70.

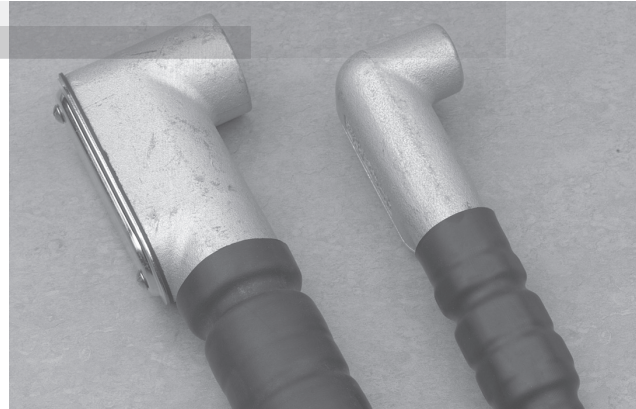

Features:

- Simple installation, requires no tools
- Accommodates a wide range of bulkhead connectors
- No torches or heat required
- Good thermal stability
- Are designed to seal tight, retain its resiliency and pressure after prolonged years of aging and exposure
- Excellent wet electrical properties
- Salt spray resistant. Meets requirements of ASTM B287, in a 5% salt solution with a 3.0-3.1 pH
- Water-resistant. Meets the water seal requirements of ANSI C119.1
- Resists fungus
- Resists acids, alkalies and ozone

3M Cold Shrink Corrosion Protection Kit CPT Series Sizing Guide

Product Number (NPT Size)	UPC (054007-)	Cable O.D. Minimum in. (mm)	Connector		Inner Unit Pack	Min. Order Case Qty.
			Maximum O.D. in. (mm)	Maximum Installed Length in. (mm)		
CPT-1/2	43021	0.50" (13 mm)	1.60" (41 mm)	4.50" (114 mm)	—	10
CPT-3/4	43022	0.66" (17 mm)	1.90" (48 mm)	4.80" (122 mm)	—	10
CPT-1	43023	0.66" (17 mm)	2.20" (56 mm)	4.80" (122 mm)	—	10
CPT-1-1/4	43024	1.22" (31 mm)	2.65" (67 mm)	4.80" (122 mm)	—	10
CPT-1-1/2	43025	1.40" (36 mm)	3.00" (76 mm)	5.50" (140 mm)	—	10
CPT-2	43026	1.68" (43 mm)	3.60" (91 mm)	6.50" (165 mm)	—	10
CPT-2-1/2	43027	1.97" (50 mm)	4.30" (109 mm)	8.50" (215 mm)	—	5
CPT-3	43028	2.60" (66 mm)	5.40" (137 mm)	8.50" (215 mm)	—	5
CPT-3-1/2	43029	2.90" (74 mm)	6.00" (152 mm)	10.0" (254 mm)	—	5
CPT-4	43030	2.90" (74 mm)	6.00" (152 mm)	10.5" (267 mm)	—	5

3M™ Metal Clad Jacketed Cable Connectors — Connector Cross Reference

Trade Size (inches) (NPT Size)	Cable Jacket Range (inches)		Crouse-Hinds (TMC or TMCX)	Appleton	T & B	O-Z/Gedney
	Min.	Max.				
1/2"	0.46"	0.71"	TMCX165	TMCX6550	ST050-462 ST050-464	JMC-50-71
3/4"	0.65"	0.93"	TMCX285	TMCX8875	ST075-467 ST075-468	JMC-75-115
1"	1.10"	1.45"	TMCX3112	TMCX118100	ST100-469	JMC-100-145
1-1/4"	1.37"	1.79"	TMCX4140	TMCX140125	ST125-470 ST125-550 ST125-471	JMC-125-179
1-1/2"	1.74"	2.15"	TMCX5161	TMCX166150	ST150-472 ST150-473	JMC-150-215
2"	2.03"	2.59"	TMCX6206	TMCX206200	ST200-551 ST200-474 ST200-475 ST200-476	JMC-200-259
2-1/2"	2.47"	3.03"	TMCX7247	TMCX251250	ST250-477 ST250-478	JMC-250-303
3"	2.93"	3.61"	TMCX8302	TMCX304300	ST300-479 ST300-480 ST300-481	JMC-300-361
3-1/2"	3.55"	4.23"	TMCX9352	TMCX359350	ST350-482 ST350-483	JMC-350-423
4"	4.05"	4.73"	TMCX10402	TMCX402400	ST400-484 ST400-485	JMC-400-473

Preparation and Cleaning



3M™ Scotch-Brite™ Hand Pads 7440 Series

3M Scotch-Brite Pads make the toughest cleaning jobs easier. These pads are so versatile. They are designed to outperform steel wool, wire brushes, sandpaper and other nonwoven surface conditioning products and can be used with water or solvents. They resist tearing, splintering, shredding and loading and will never rust. All Scotch-Brite Pads measure 6" x 9" (152 x 228 mm). Blending Pads are made of a coarse mineral abrasive. General Purpose Pads are reusable—they rinse clean and are constructed of a nylon web. Ultra Fine Pads are highly conformable.

Select the Scotch-Brite Pads for your specific abrasion needs and carry them with you everywhere you work. You can use them on virtually any surface material, including all kinds of metals, plastics, composites, ceramics, porcelain, glass and rubber.



3M™ Cable Cleaning System CC Series

3M Cable Cleaning System CC Series cleans cable insulation, metal, electrical and mechanical parts. It can be used for PCB cleanup and in parts cleaners for degreasing. CC series solvent is also suitable for use on transformers, generators, motors and metal parts of all sorts. It removes surface oils, tars and heavy greases. Use of solvent on carbon-containing semiconductive surfaces such as cable insulation shields is not recommended.

CC series solvent can effectively replace 1.1.1- trichlorethane and other hazardous solvents. Neither CC series solvent nor its ingredients are presently subject to regulations that would inhibit shipping, packaging or applications.

CC-Dry contains three each 4" x 8" (102 x 203 mm) lintless non-woven pads packed in a bag. These are used for drying the common citrus cable cleaner (CC series) off of cable installation when preparing cable. The CC-2-Dry Kit contains a CC-2 Kit and three each dry lintless pads.

Specifications and Ordering Information for 3M™ Scotch-Brite Hand Pads 7440 Series

Specifications	Blending Pads 7446	General Purpose Pads 7447	Ultra Fine Pads 7448
Features	<ul style="list-style-type: none"> · Hand blending and finishing stainless steel and aluminum · Light oxide removal · Paint removal · Wood highlighting 	<ul style="list-style-type: none"> · Scuff sanding, cleaning, finishing and deburring · Use for car reconditioning — cleaning upholstery, headliners, white-wall tires, door pads and chrome · Deburring metals and ceramics · Cleaning machinery 	<ul style="list-style-type: none"> · Light duty — ideal for cosmetic cleaning and creating consistent finishes
Electrical Applications		<ul style="list-style-type: none"> · Cleaning cable jackets, insulation and conductors · Cleaning and polishing bus bar · Cleaning insulators and cable accessories · Rust removal from metal cabinets · Relay contact cleaning · Battery connections 	
Color	Gray	Maroon	Gray
Size	6 x 9" (152 x 228 mm)	6 x 9" (152 x 228 mm)	6 x 9" (152 x 228 mm)
Ordering Information			
UPC (048011-)	04051	04029	04028
Pads/Box	1	1	1
Case Qty.	1 case	1 case	1 case

Specifications and Ordering Information for 3M™ Cable Cleaning System CC Series

Specifications	CC-2	CC-Dry	CC-2-Dry	CC-3	CC-4
Description	Cable Cleaning Preparation Kit	Cable Cleaning Pads	Cable Cleaning Pads and Kit	Cable Cleaning Pad Kit	Cable Cleaning Solvent (quart bottle)
Ordering Information					
UPC (054007-)	49563	43415	43414	49564	49565
Case Qty.	10 each	10 kit	10 kit	10 each	4 each

Scotch® Electrician's Abrasive Roll A-3

Scotch Electrician's Abrasive Roll A-3 is a 120-grit, closed-coat aluminum oxide strip, which is nonconductive and flexible. It is packaged in a dispenser-type box.



Ordering Information for Scotch® Electrician's Abrasive Roll A-3

Product Number	UPC (054007-)	Size/Type of Package	Inner Unit Pack	Case Qty.
A-3	11560	1" x yd./Grit 120J (25,4 mm x 22,7 m)	5 rls	10 rls

3M™ Electrostatic Animal Guard

3M Electrostatic Animal Guard (formerly Guthrie Guard) is a patented electrostatic barrier which attaches to energized electrical insulators/bushings rated up to 35 kV. The guard consists of rugged plastic with metal spokes radiating outward. When an animal touches the spokes, it receives an electric shock similar to those generated by electrified livestock fences. The animal is not injured and power service is not interrupted.

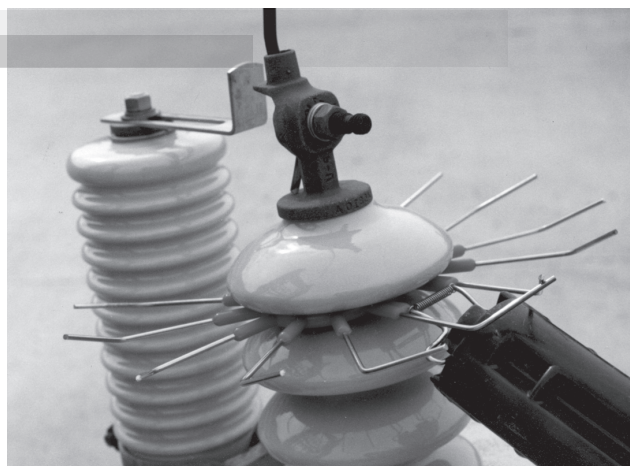

With 3M Electrostatic Animal Guard, electric utilities can minimize customer outages due to animal contact. 3M Electrostatic Animal Guard offers several advantages over other conventional cover-up devices:

- Can be installed while circuit is energized
- Maximum longevity
- Humane

3M Electrostatic Animal Guard Specifications and Ordering Information

Product Number	UPC (054007-)	Insulator Neck Diameter Range* in. (mm)
GG-7525	43128	0.75-2.5" (19,1-63,7 mm)
GG-1525	43125	1.5-2.5" (38,2-63,7 mm)
GG-2545	43126	2.5-4.5" (63,7-114,7 mm)
GG-4565	43127	4.5-6.5" (114,7-165,7 mm)

*Insulator neck diameter range is defined as the diameter of the insulator in between the skirts.

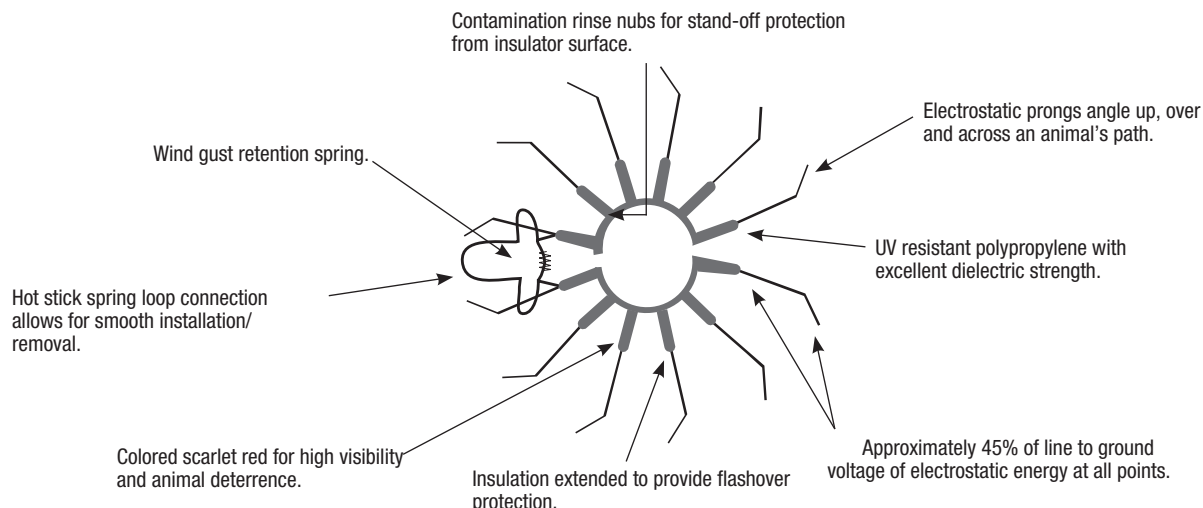

Overhead Conductor Animal Guard Cover

3M™ Conductor Covers CCI Series are extruded silicone rubber tubes designed for field installation over bare conductors to insulate them from adjacent phases, grounded equipment, and animal contact. These covers are made with a full-length longitudinal bias cut to allow for easy slip-on installation, and provide an increased creepage distance between the conductor and the outer surface of the cover.

The covers are offered in two thickness sizes for covering both 15 kV and 25 kV rated conductors, and are available in ACSR conductor sizes from 2 AWG to 266 kcmil.

Features:

- Excellent UV, arc and ozone resistance
- Good dielectric strength, conformability and cold weather installation
- Munsel grey color
- Bias cut enables easy field installation without any special tools

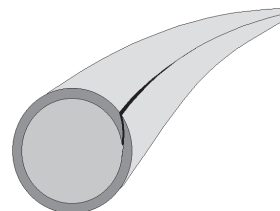

Typical Dimensions

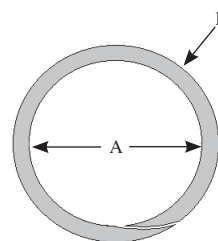

3M™ Conductor Covers CCI Series

Specifications and Ordering Information for 3M Conductor Covers CCI Series

Product Number	UPC (054114-)	ACSR Conductor Size	Conductor Voltage Rating	Dimension A	Dimension B	Order Quantity
CCI-2-125	04238	2 AWG	15 kV	0.34" (9 mm)	0.125" (3 mm)	100 ft. rolls
CCI-2/0-125	04239	2/0 AWG	15 kV	0.46" (12 mm)	0.125" (3 mm)	100 ft. rolls
CCI-266-125	04241	266 kcmil	15 kV	0.63" (16 mm)	0.125" (3 mm)	100 ft. rolls
CCI-2/0-200	04240	2/0 AWG	25 kV	0.46" (12 mm)	0.200" (5 mm)	100 ft. rolls
CCI-266-200	04242	266 kcmil	25 kV	0.63" (16 mm)	0.200" (5 mm)	100 ft. rolls

