

600 Watts

- Wide 4:1 Input Range
- Covers 72 & 110VDC for Rail Applications
- Complies with EN50155
- Meets EN50121-3-2
- Single Output
- Industry Standard Full Brick
- -40°C to +100°C Operation
- Output Trim 60-110%
- Remote On/Off
- 3 Year Warranty

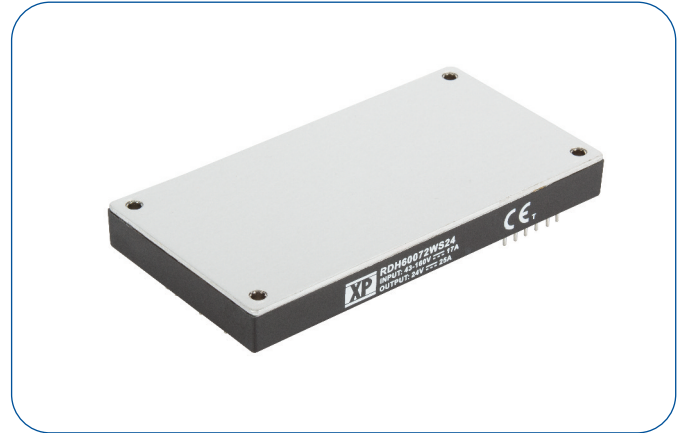

Dimensions:

RDH600:
2.4 x 4.6 x 0.5" (61.0 x 116.8 x 12.7 mm)

The RDH600 family of DC-DC converters offers an EN50155 compliant solution in an industry standard format. The construction is robust and designed for harsh environments.

Models & Ratings

Input Voltage	Output Voltage	Output Current	Input Current		Ripple & noise ⁽¹⁾	Efficiency ⁽²⁾	Max. capacitive load	Model Number
			No Load	Full Load ⁽³⁾				
43-160 V	12 V	50.0 A	25 mA	16.00 A	120 mV	87%	10000 µF	RDH60072WS12
	24 V	25.0 A	25 mA	15.85 A	240 mV	88%	5000 µF	RDH60072WS24
	28 V	21.4 A	25 mA	15.85 A	280 mV	88%	5000 µF	RDH60072WS28
	48 V	12.5 A	25 mA	15.85 A	480 mV	88%	5000 µF	RDH60072WS48

Notes

1. Measured at 20 MHz bandwidth pk-pk, full load, 10 µF aluminum solid and 1.0 µF ceramic capacitors.

2. Measured at 110 V input and full load.

3. Measured at 43 VDC input.

Mechanical Details

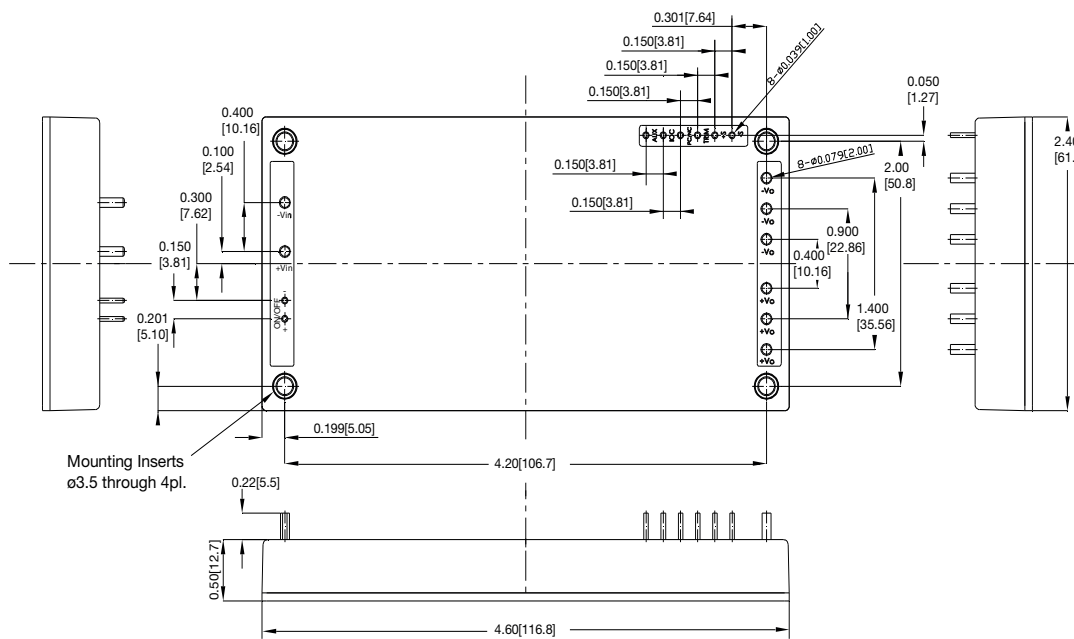

Pin	Function
1	-Vin
2	+Vin
3	REM-
4	REM+
5-7	+Vout
8-10	-Vout
11	-Sense
12	+Sense
13	Trim
14	Current Share
15	Power Good
16	Auxilliary, 7-13 V/20 mA

Notes

1. All dimensions are in inches (mm)
2. Weight: 0.485 lbs (220 g) approx.

3. Tolerance: x.xx = ±0.02 (x.x = ±0.5)
x.xxx = ±0.01 (x.xx = ±0.25)

Input

Characteristic	Minimum	Typical	Maximum	Units	Notes & Conditions
Input Voltage Range	43		160	VDC	72/110 V nominal inputs
Input Surge			180	VDC for 100 ms	
Undervoltage Lockout	On: >41 V	42	43	VDC	On
	Off: <39 V	40	41		Off
Lockout Hysteresis		2		VDC	
Idle Current	1		10	mA	When output is inhibited
Inrush Current			1	A ² s	
Recommended Input Fuse		20		A	Time delay
Input Reflected Ripple Current		40		mA pk-pk	Through 12 µH inductor

Output

Characteristic	Minimum	Typical	Maximum	Units	Notes & Conditions
Output Voltage	12		48	VDC	See Models and Ratings table
Output Trim	-40		+10	%	See Application Note
Initial Set Accuracy			±1.5	%	At full load and 110 V input
Minimum Load	0			%	No minimum load required
Line Regulation			±0.2	%	From minimum to maximum input at full load
Load Regulation			±0.5	%	From 0% to full load
Transient Response		±3.0	±5.0	%	Maximum deviation, recovering to less than 1% in 500 µs for 25% step load change.
Start Up Time			250	ms	
Output Voltage Rise Time			50	ms	
Ripple & Noise				mV pk-pk	See models and ratings table
Overload Protection	110	125	160	%	
Short Circuit Protection					Continuous hiccup mode, with auto recovery
Maximum Capacitive Load					See Models and Ratings table
Temperature Coefficient			0.02	%/°C	
Overvoltage Protection	115	125	140	%	
Remote On/Off	Output is on if REM+ (pin 4) is open or high (3.5-75 VDC) WRT REM- (pin 3) or -Vin Output turns off if REM+ (pin 4) is low (<1.2 VDC max) WRT REM- (pin 3) or -Vin Positive logic turns the module off if a current of 1 and 10 mA is flowing between remote control pins 3 & 4. See application notes.				

General

Characteristic	Minimum	Typical	Maximum	Units	Notes & Conditions
Efficiency		88		%	See Models and Ratings table
Isolation: Input to Output	2250			VDC	60 s
Isolation: Input to Case	2250			VDC	60 s
Isolation: Output to Case	1500			VDC	60 s
Isolation Resistance	10 ⁷			Ω	
Isolation Capacitance		4000		pF	Input to output
Switching Frequency		250		kHz	
Power Density			109	W/in ³	
Mean Time Between Failure		450		kHrs	MIL-HDBK-217F, +25 °C GB
Case Material	Plastic DAP UL94V-0 with aluminium base plate				
Potting Material	Epoxy UL94V-0				
Pin Material	Copper with nickel and matte tin plating				
Fire and Smoke	Meets EN45545-2				
Weight		0.485 (220.0)		lb (g)	

Environmental

Characteristic	Minimum	Typical	Maximum	Units	Notes & Conditions
Operating Base Plate Temperature	-40		+100	°C	
Storage Temperature	-55		+105	°C	
Thermal Protection		+110		°C	Measured on baseplate
Humidity			95	%RH	Non-condensing
Cooling					Base plate cooled
Altitude			2000	m	Transportation 12000 m
Shock and Vibration					Meets EN61373. Designed to meet MIL STD-810F

Application Notes

Input Fusing and Safety Considerations

The RDH600 series converters have no internal fuse. In order to achieve maximum safety and system protection, always use an input line fuse. We recommended a 20 A time delay fuse. It is recommended that the circuit has a transient voltage suppressor diode (TVS) across the input terminals to protect the unit against surge or spike voltages and input reverse voltage (as shown). A suitable part would be 1.5 KE180 A Littelfuse.

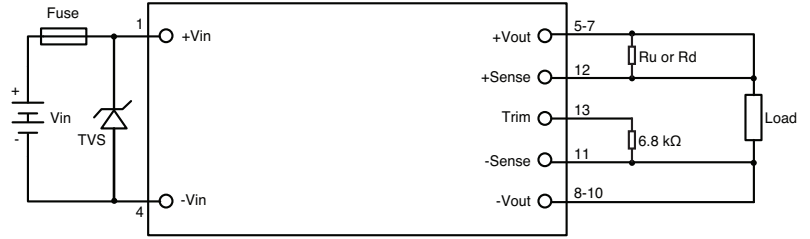

Output Voltage Adjustment

The Trim input permits the user to adjust the output voltage up by 10% or down by 40%. This is accomplished by connecting a mandatory external resistor between the Trim pin and -Sense pin of recommended value 6.8 kΩ. Then select Ru and Rd to determine desired output voltage.

Output Voltage Sensing

The module will automatically trim the output voltage via the sense pins to the default values either locally or at the load. If not required, the sense pins should be connected locally as indicated in the example EMC circuit.

To Trim Down (Rd)

Trim Down%	12 V	24 V	28 V	48 V
	Rd (kΩ)			
1	387.92	396.61	603.07	387.92
2	235.74	238.95	301.84	235.74
3	168.34	169.98	199.92	168.34
4	130.30	131.30	148.68	130.30
5	105.88	106.54	117.84	105.88
6	88.87	89.34	97.24	88.87
7	76.34	76.69	82.50	76.34
8	66.73	67.00	71.44	66.73
9	59.12	59.33	62.83	59.12
10	52.95	53.12	55.94	52.95
11	47.84	47.99	50.30	47.84
12	43.55	43.67	45.60	43.55
13	39.88	39.99	41.62	39.88
14	36.72	36.81	38.21	36.72
15	33.97	34.04	35.25	33.97
16	31.54	31.61	32.66	31.54
17	29.40	29.46	30.38	29.40
18	27.48	27.53	28.35	27.48
19	25.76	25.81	26.53	25.76
20	24.21	24.25	24.89	24.21
21	22.80	22.83	23.41	22.80
22	21.51	21.54	22.07	21.51
23	20.34	20.37	20.84	20.34
24	19.26	19.28	19.71	19.26
25	18.26	18.28	18.67	18.26
26	17.34	17.36	17.72	17.34
27	16.48	16.50	16.83	16.48
28	15.69	15.71	16.01	15.69
29	14.95	14.97	15.24	14.95
30	14.26	14.27	14.53	14.26
31	13.61	13.62	13.86	13.61
32	13.00	13.01	13.23	13.00
33	12.43	12.44	12.64	12.43
34	11.89	11.90	12.09	11.89
35	11.38	11.39	11.56	11.38
36	10.90	10.91	11.07	10.90
37	10.44	10.45	10.60	10.44
38	10.01	10.02	10.16	10.01
39	9.599	9.608	9.739	9.599
40	9.209	9.217	9.34	9.209

To Trim Up (Ru)

Trim Up %	12 V	24 V	28 V	48 V
	Ru (kΩ)			
1	0.049	0.106	0.272	0.196
2	0.168	0.345	0.55	0.673
3	0.288	0.583	0.829	1.15
4	0.407	0.822	1.107	1.627
5	0.526	1.061	1.385	2.104
6	0.645	1.299	1.664	2.582
7	0.765	1.538	1.942	3.059
8	0.884	1.776	2.221	3.536
9	1.003	2.015	2.499	4.013
10	1.123	2.253	2.777	4.49

Remote Control

Controlling the on/off from the input side, recommend R1 value is 42K (1W) for 110 Vin.

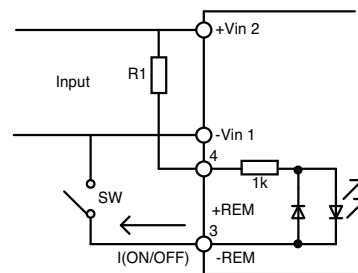

Controlling the on/off from the output side, recommend R2 value is 5.1k (0.1W).

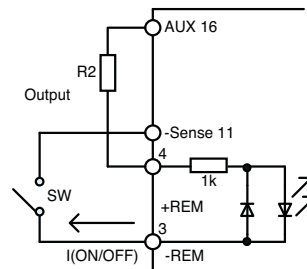

Application Notes

Thermal Resistance Information

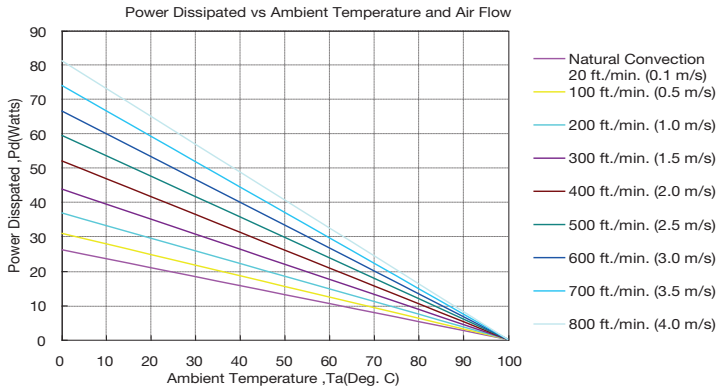

Air Flow Rate	Typical Rca
Natural Convection 20 ft/min (0.1 m/s)	3.82 °C/W
100 ft/min (0.5 m/s)	3.23 °C/W
200 ft/min (1.0 m/s)	2.71 °C/W
300 ft/min (1.5 m/s)	2.28 °C/W
400 ft/min (2.0 m/s)	1.92 °C/W
500 ft/min (2.5 m/s)	1.68 °C/W
600 ft/min (3.0 m/s)	1.50 °C/W
700 ft/min (3.5 m/s)	1.35 °C/W
800 ft/min (4.0 m/s)	1.23 °C/W

Airflow Derating Graph

Example (Without Heatsink)

To determine the minimum airflow necessary for a RDH60072WS12 operating at an input voltage of 110 V, an output current of 30 A, and a maximum ambient temperature of 30°C:

Determine Power dissipation (Pd): $P_d = P_i - P_o = P_o(1-\eta)/\eta$,

$$P_d = 12 \text{ V} \times 30 \text{ A} \times (1-0.87)/0.87 = 54 \text{ Watts}$$

Where P_i = Input power, P_o = Output Power and η = Efficiency

Determine airflow from airflow derating graph using data points for $P_d=54 \text{ W}$ and $T_a = 30 \text{ °C}$

Minimum airflow= 800 ft./min.

To check that the maximum case temp of 100 °C is not exceeded:

Maximum temperature rise is
 $\Delta T = P_d \times R_{ca} = 54.0 \times 1.23 = 66.42 \text{ °C}$.

Maximum case temperature is

$$T_c = T_a + \Delta T = 96.42 \text{ °C} < 100 \text{ °C}$$

Where: R_{ca} is the thermal resistance from case to ambient environment. T_a is ambient temperature and T_c is case temperature.

Note: For heatsink solutions please contact XP Sales or Applications Engineering.

Application Notes

EMC Filter - Emissions and Immunity

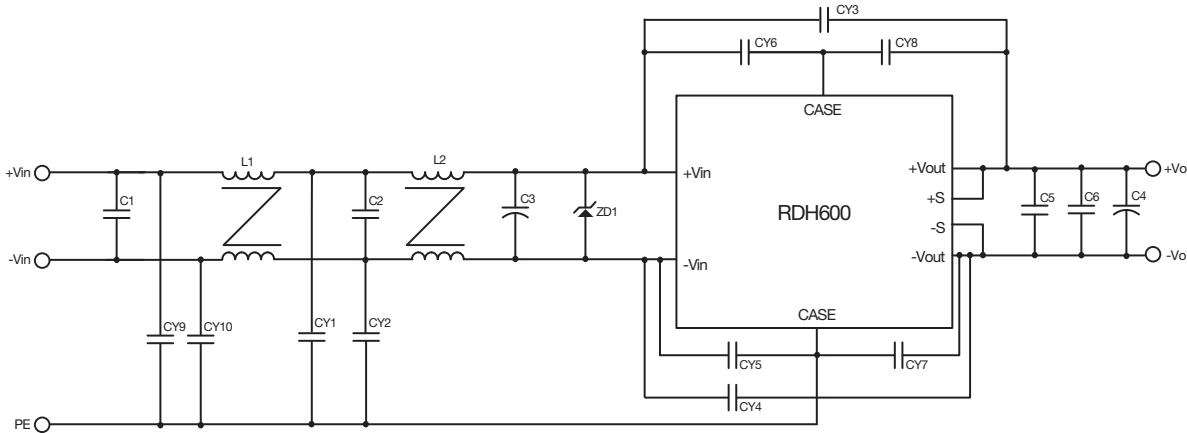

Model	C1	C2	C3	C4	C5	C6	CY1	CY2	CY3	CY4
RDH60072WS12 RDH60072WS24	X2 CAP, 0.47 μ F	X2 CAP, 0.47 μ F	220 μ F/ 200 V, YXF	470 μ F/ 50 V, KY	10 μ F/50 V	1 μ F/50 V	Y1 CAP, 470 pF	Y1 CAP, 470 pF	Y1 CAP, 2200 pF	Y1 CAP, 2200 pF
	CY5	CY6	CY7	CY8	CY9	CY10	L1	L2	ZD1	
	Y1 CAP, 4700 pF	Y1 CAP, 4700 pF	Y1 CAP, 10000 pF	Y1 CAP, 10000 pF	NC	NC	3.8 mH	3.8 mH	1.5KE180A	
RDH60072WS28	X2 CAP, 0.47 μ F	X2 CAP, 0.47 μ F	220 μ F/ 200 V, YXF	470 μ F/ 50 V, KY	10 μ F/50 V	1 μ F/50 V	Y1 CAP, 470 pF	Y1 CAP, 470 pF	Y1 CAP, 1000 pF	Y1 CAP, 1000 pF
	CY5	CY6	CY7	CY8	CY9	CY10	L1	L2	ZD1	
	Y1 CAP, 4700 pF	Y1 CAP, 4700 pF	Y1 CAP, 10000 pF	Y1 CAP, 10000 pF	NC	NC	3.8 mH	3.8 mH	1.5KE180A	
RDH60072WS48	X2 CAP, 0.47 μ F	X2 CAP, 0.47 μ F	220 μ F/ 200 V, YXF	470 μ F/ 63 V, KY	4.7 μ F/ 100 V	1 μ F/100 V	Y1 CAP, 470 pF	Y1 CAP, 470 pF	Y1 CAP, 1000 pF	Y1 CAP, 1000 pF
	CY5	CY6	CY7	CY8	CY9	CY10	L1	L2	ZD1	
	Y1 CAP, 4700 pF	Y1 CAP, 4700 pF	Y1 CAP, 10000 pF	Y1 CAP, 10000 pF	Y1 CAP, 4700 pF	Y1 CAP, 4700 pF	3.8 mH	3.8 mH	1.5KE180A	